



HDC-2080Z03 D

Article number: 211421

1/3" HD-SDI Camera, WDR, Day&Night, 1920x1080, 3x AF Zoom, 3-9mm, 12/24V

Mainfeatures

1/3" 2.0 MP progressive scan CMOS sensor

1.5G HD-SDI video transmission via coax

Optical 3x auto focus zoom, 32x digital

Removable infrared cut filter

3D-DNR noise reduction, Defog function

Zoom on defined ROI on motion

Resolution max. 1920x1080 (Full HD)

EX-SDI (270Mbps) Advanced HD signal range

3~9mm day&night lens

Real time WDR (Wide Dynamic Range) 25/30fps

Integral motion detection

External input for day/night switching

Specifications

Sensor size	1/3"
Imager	CMOS
Imager	Panasonic Progressive Scan
System	True Day&Night
Sensitivity	0,35 Lux
Sensitivity	(colour), 0.002Lux (B&W), 40IRE
Low speed shutter	yes
Low speed shutter	2x ~ 8x
Manual electronic shutter (MES)	1/25~1/60000sec.
Wide Dynamic Range (WDR)	WDR, D-WDR
Wide Dynamic Range (WDR)	Real Time WDR 25/30fps, 93dB
Flickerless function	yes

HDC-2080Z03 D

Specifications continued

Backlight compensation	BLC, HLC
IR cut filter	switchable
Automatic electronic shutter (ESC)	1/25~1/60000sec.
White balance	ATW, one push, manual
Signal-to-noise ratio	-50 db
Signal format	HD-SDI (1.485 Gbps), EX-SDI (270 Mbps)
Frame rate	1080 @ 25/30p, 720 @ 25/30p
Lens type	auto focus zoom
Focal length	3 - 9 mm
Digital zoom	2x ~ 32x
Aperture range (F)	F1.2~F2.1
Filter screw size	not available
Resolution	1920x1080 (16:9), 1280x720 (16:9)
Horizontal angle of view	106 - 36 °
Active picture elements	1944(H) x 1092(V)
Motion detector	yes
Analysis functions	activity detection
e-PTZ support	no
OSD function control	AGC, motion detection, DNR, shutter control, day&night, privacy zones, white balance
Menu languages	English, Japanese, German, French, Italian, Spanish, Polish
Privacy zones masking	ON/OFF switchable
Mirror function	V flip, H-flip, H/V flip
Digital Noise Reduction (DNR)	2D-DNR, 3D-DNR
Digital Noise Reduction (DNR)	yes
Video outputs	HD-SDI / EX-SDI selectable, CVBS
External connections	RS-485, voltage input, HD-Signal BNC output, external day&night switching
Alarm inputs	no
Alarm outputs	no
Serial interfaces	RS-485
Serial interfaces protocols	Pelco D
Series	eneo Candid Box
Dimensions (HxWxD)	72x74x89mm
Illumination	no
Colour (housing)	Pantone 7541
Housing material	metal (aluminium)
Weight	340g
Integrated wall mount	no
Power consumption	3W
Window heater	no
Protection rating	n/a
Supply voltage	(+/-15%) 50Hz
Supply voltage	12VDC, 24VAC
Temperature range (operation)	-10°C ~ +50°C

HDC-2080Z03 D

Specifications continued

Text display	camera title
Vandalism resistant	no
Certificates	CE
Parts supplied	manual

Special features

Pointing Zoom -- enables the flexible zooming at any area







Smart Motion Zoom--Zoom on defined ROI on motion

Preset Zoom (4 adjustable positions)

COLOR D / N Fixed color mode, optimized for applications with white light illumination

HDC-2080Z03 D

Available Accessories

Bild	Art. Nr. / Bezeichnung	Beschreibung
	200817 / HDA-1004D	Distributor HD-SDI, 1 x HD-SDI Input, 4 x HD-SDI Outputs
	203658 / VT-PS12DC-11	Plug-in Power Supply Unit, 100-240VAC/12VDC (1.0A), Regulated, with DC Plug
	70688 / WD-18	Wall Mount with Ball Joint, 1/4" Camera Fixing Screw, beige Grey
	70769 / WD-22	Wall Mount Bracket with Ball Joint, 1/4" Camera Fixing Screw, Beige Grey
	70835 / WD-12-WA	Wall Mount with Ball Joint, 1/4" Camera Fixing Screw, 140mm, RAL9006
	210224 / HDA-2002EC	Extender/Converter 1 x HD-SDI Input, 1 x HDMI Output
	211257 / HDA-3000E	HD Extender, HD-SDI, EX-SDI, 12V

HDC-2080Z03 D

Technical Drawing

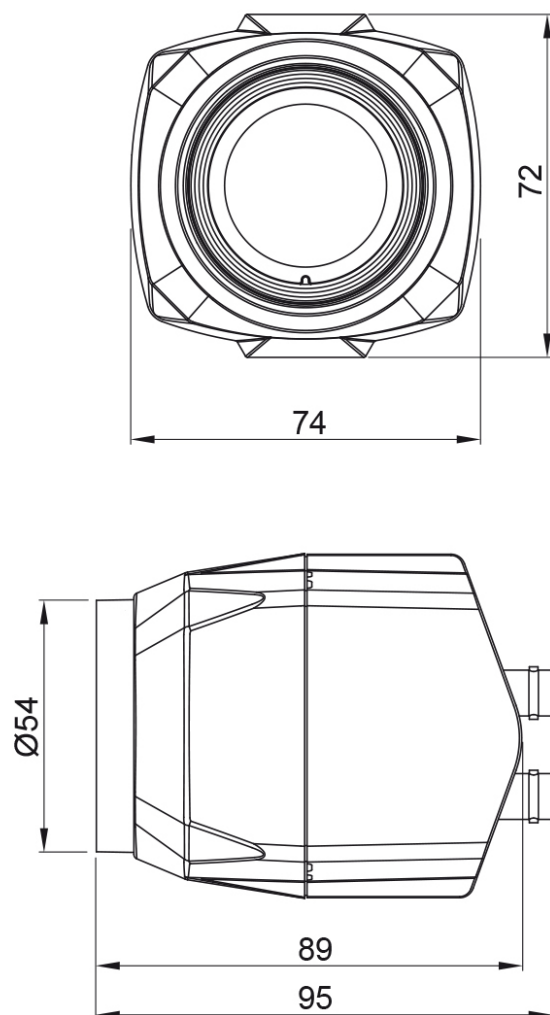

Maße/Dimensions: mm

Your Contact Person



eneo is a registered trademark of
VIDEOR E. Hartig GmbH
Carl-Zeiss-Straße 8
63322 Rödermark
Deutschland
Tel.: +49 6074-888-333
E-Mail: info@eneo-security.com
Web: www.eneo-security.com