



## HDB-980MIR

Article number: 208984

1/2.9" HDcctv Camera, WDR, Day&Night, 1920x1080, 3.6mm, Infrared, 12VDC

### Mainfeatures

1/2.9" 2.0 MP progressive scan CMOS sensor

4mm Mega Pixel lens

IR illumination

Integral motion detection

Easy indoor and outdoor installation

Resolution max. 1920x1080 (Full HD)

Removeable infrared cut filter

WDR, 2&3DNR Noise Reduction, Defog function

1.5G HD-SDI video transmission via coax

### Specifications

Sensor size	1/2.9"
Imager	CMOS
Imager	Sony
System	True Day&Night
Sensitivity	0,5 Lux
Sensitivity	(Colour) 0,1Lux (BW)
Low speed shutter	yes
Low speed shutter	2x ~ 4x
Manual electronic shutter (MES)	1/25~1/60000sec.
Wide Dynamic Range (WDR)	WDR
Wide Dynamic Range (WDR)	93dB
Flickerless function	yes
Backlight compensation	BLC, HLC
IR cut filter	switchable







# HDB-980MIR

## Specifications continued

Automatic electronic shutter (ESC)	1/25~1/60000sec.
White balance	automatic, manual, indoor, outdoor, one push
Signal-to-noise ratio	50dB
Frame rate	1080 @ 25/30p, 720 @ 50/60p
Synchronization	internal
Lens type	fixed focal length
Focal length	3,6 mm
Aperture range (F)	F2.0
Resolution	1920x1080 (16:9), 1280x720 (16:9)
Horizontal angle of view	86 °
Motion detector	yes
OSD function control	OSD camera setup
Menu languages	English
Privacy zones masking	24 zones masking
Mirror function	V flip, H-flip, H/V flip
Digital Noise Reduction (DNR)	2D-DNR, 3D-DNR
Digital Noise Reduction (DNR)	yes
Video outputs	HD-SDI (BNC)
External connections	12VDC power input, HD-Signal BNC output
Alarm inputs	no
Alarm outputs	no
Serial interfaces	no
Dimensions (HxWxD)	see drawing
Illumination	infrared
Illumination	24x IR LED
Colour (housing)	white
Housing	outdoor
Housing material	metal (aluminium)
Weight	430g
Integrated wall mount	yes
Power consumption	5W
Mounting	wall mount, ceiling mount
Window heater	no
Protection rating	IP66
Hidden cable management	yes
Sunshield	no
Supply voltage	12VDC
Temperature range (operation)	-10°C ~ +50°C
Text display	supplied
Vandalism resistant	no
Certificates	CE
Parts supplied	manual, screw set

# HDB-980MIR

## Available Accessories

Bild	Art. Nr. / Bezeichnung	Beschreibung
	200817 / HDA-1004D	Distributor HD-SDI, 1 x HD-SDI Input, 4 x HD-SDI Outputs
	200818 / HDA-1001E	Repeater HD-SDI, 1 x HD-SDI Input, 1 x HD-SDI Output
	203658 / VT-PS12DC-11	Plug-in Power Supply Unit, 100-240VAC/12VDC (1.0A), Regulated, with DC Plug
	204246 / HDA-1010TRE	HD-SDI Extender, Transmitter-Receiver Pair, Coaxial Cable Transmission
	204247 / HDA-1020TRB	HD-SDI Balun, Transmitter-Receiver pair, UTP cable transmission
	210224 / HDA-2002EC	Extender/Converter 1 x HD-SDI Input, 1 x HDMI Output

# HDB-980MIR

## Technical Drawing

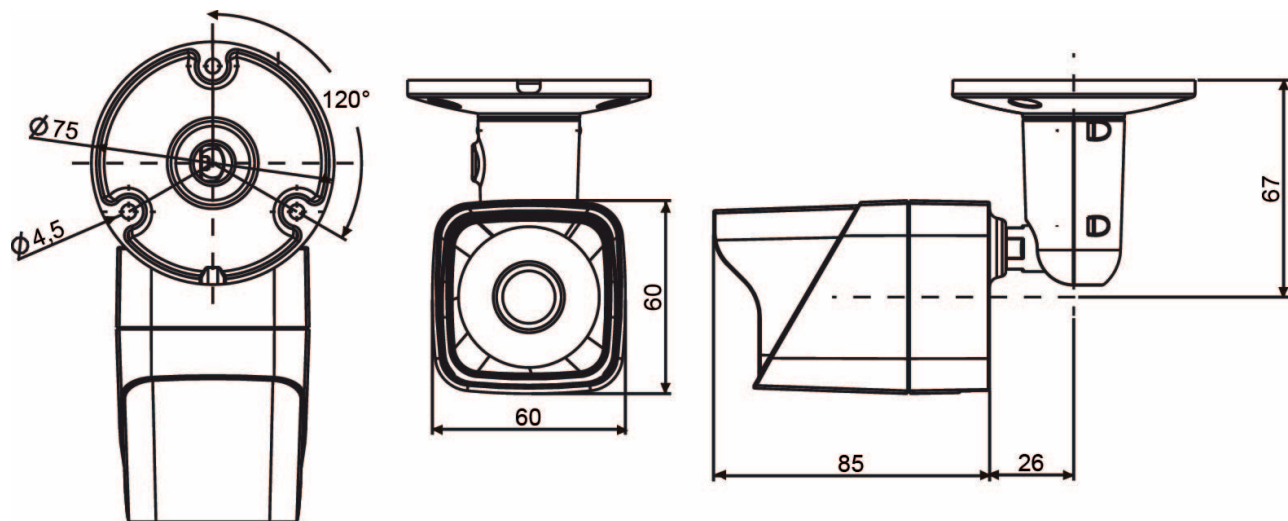

Dimensions: mm

## Your Contact Person



eneo is a registered trademark of  
VIDEOR E. Hartig GmbH  
Carl-Zeiss-Straße 8  
63322 Rödermark  
Deutschland  
Tel.: +49 6074-888-333  
E-Mail: info@eneo-security.com  
Web: www.eneo-security.com