



PTB-1125F19

Article number: 202976

Thermal Imaging Network Camera, 336x256, 25 Hz, USB, Analogue, 19mm, 17°, 12/24V, PoE

Mainfeatures

Thermal camera with Ethernet and Composite Video out

19mm lens

Exclusive design for indoor and outdoor applications IP67

Bullet housing for ceiling and wall mounting

Easy installation, central locking screw

3 Years eneo warranty

Resolution 336x256 Pixel, 25 Hz

Easy handling, USB and RS-422 remote interface

Compression standards: H.264/MJPEG

Covered cabling

Flexible power supply 12VDC, 24VAC or PoE

Specifications

Resolution pixels	336x256
System	thermal image
Compression standard	H.264, M-JPEG
Stream types	1x H.264, 1x MJPEG simultan
Image transmission rate max.	25 fps
Multicast compliant	yes
Compression standard	H.264, M-JPEG
Lens type	fixed focal length
Focal length	19 mm
Geometrical Resolution (IFOV)	895 mrad
Vertical angle of view	13 °
Horizontal angle of view	17 °

PTB-1125F19

Specifications continued

Pixel pitch	17 µm
Motion detector	yes
Alarm processing	FTP, E-Mail
Audio support	no
Detection range	Man, 1950m, Vehicle
Detection range	640m
Internal storage	no
Menu languages	English
Privacy zones masking	ON/OFF switchable
Remote configuration	web browser, remote software
Web browser	MS Internet Explorer vers. 7.0 or higher, Mozilla Firefox (Java), Safari (Java), Google Chrome (Java)
Network protocols	HTTP, TCP, UTP, ARP, IPv4, ICMP, RTP, RTSP, PPPoE, SMTP, DHCP, NTP, UPnP, Telnet, FTP
Video outputs	composite (CVBS)
Alarm inputs	no
Serial interfaces	RS-422, USB, Ethernet
Series	eneo Candid Medium
Construction	Bullet housing, Thermal camera
Spectral area	7,5 - 13,5 µm
Colour (housing)	Pantone 7541
Housing	outdoor
Housing material	metal (aluminium)
Weight	1.4 kg
Integrated wall mount	yes
Power consumption	12W
Management Software Support	www.eneo-security.com/en/products/videmanagement.html
Mounting	wall mount, ceiling mount
ONVIF	yes, Profile S
Protection rating	IP67
SDK	upon request
Hidden cable management	yes
Supply voltage	12VDC, 24VAC, PoE
Temperature range (operation)	-35°C ~ +50°C
Thermal sensitivity at 25°C	50 mK
Vandalism resistant	no
Certificates	CE
Parts supplied	manual, screw set, allen key, mounting plate, Video sub-out cable, USB connection cable

Special features

Built-in pressure valve

More product information

These cameras may be exported or re-exported to only the following countries without approval from the EU and US authorities: The EU Member States, Australia, Japan, Canada, Liechtenstein, New Zealand, Norway, Switzerland, USA







Application for an EU export licence must be made for the following countries: Argentina, Iceland, South Korea, Turkey

Application for an export licence must be made at the EU and US authorities for all the countries not listed above except for the following countries to which exports or re-exports may not in general be made: Iran, Cuba, North Korea, Sudan, Syria

These cameras may not be sold, exported or re-exported to the armed services (Army, Navy, Air Force or Coast Guard), or to national defence and police forces, state intelligence services, reconnaissance units or any persons or groups whose actions or functions are used to pursue military tasks and objectives. These articles may not be used for the design, development, production or use of nuclear, chemical or biological weapons or missiles.

PTB-1125F19

Available Accessories

Bild	Art. Nr. / Bezeichnung	Beschreibung
	202562 / PNR-5216	Network Video Recorder, 16xIP, 1920x1080, 480fps, 1TB, H.264, MPEG-4, M-JPEG, DVI, D-Sub
	202563 / PNR-5116	Network Video Recorder, 16xIP, 1920x1080, 320fps, 1TB, H.264, MPEG-4, M-JPEG
	202641 / PM-42A	Pole mount adaptor for eneo Candid, Candid S, Candid M, Candid L, W3, WB1, AK-5, AK-4
	202888 / AK-4	Camera junction box, for Candid Small, Candid Medium, Candid Large Series
	203658 / VT-PS12DC-11	Plug-in Power Supply Unit, 100-240VAC/12VDC (1.0A), Regulated, with DC Plug
	204192 / PNR-5108	Network Video Recorder, 8xIP, 1920x1080, 200fps, 1TB, H.264, MPEG-4, M-JPEG
	204193 / PNR-5104	Network Video Recorder, 4xIP, 1920x1080, 120fps, 1TB, H.264, MPEG-4, M-JPEG
	210144 / eneo Scan Device	Management program for eneo IP Cameras

PTB-1125F19

Technical Drawing

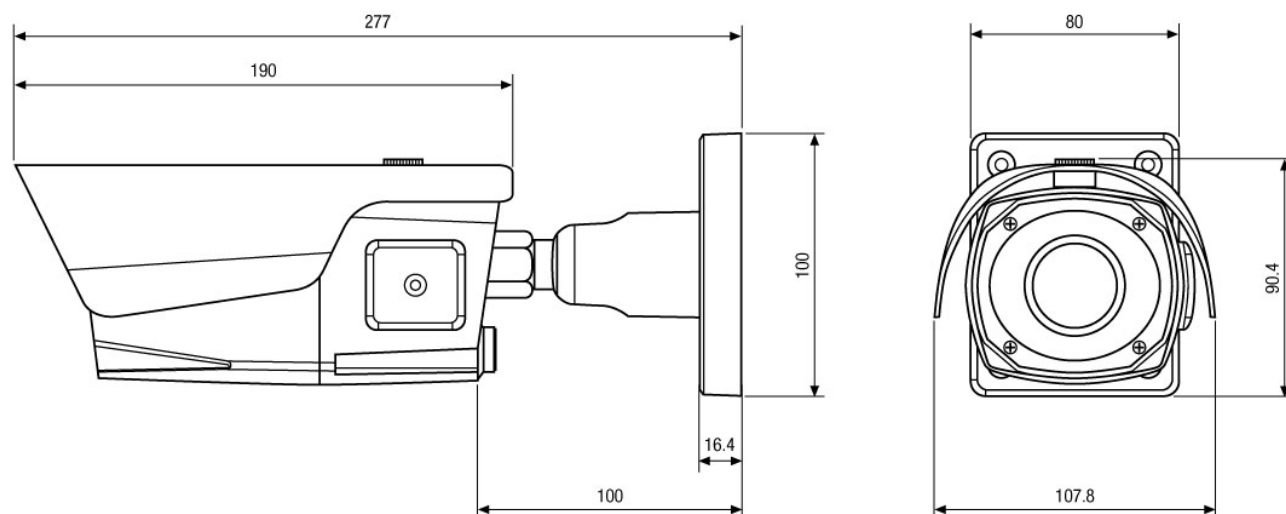

Maße/Dimensions: mm

Your Contact Person



eneo is a registered trademark of
VIDEOR E. Hartig GmbH
Carl-Zeiss-Straße 8
63322 Rödermark
Deutschland
Tel.: +49 6074-888-333
E-Mail: info@eneo-security.com
Web: www.eneo-security.com