

INSTALLATION / OPERATION / USER'S MANUAL



NXD Series MEGAPIXEL NETWORK CAMERA



WARNINGS AND CAUTIONS:

TO REDUCE THE RISK OF FIRE OR ELECTRIC SHOCK, DO NOT EXPOSE THIS PRODUCT TO RAIN OR MOISTURE. DO NOT INSERT ANY METALLIC OBJECTS THROUGH THE VENTILATION GRILLS OR OTHER OPENINGS ON THE EQUIPMENT.

CAUTION

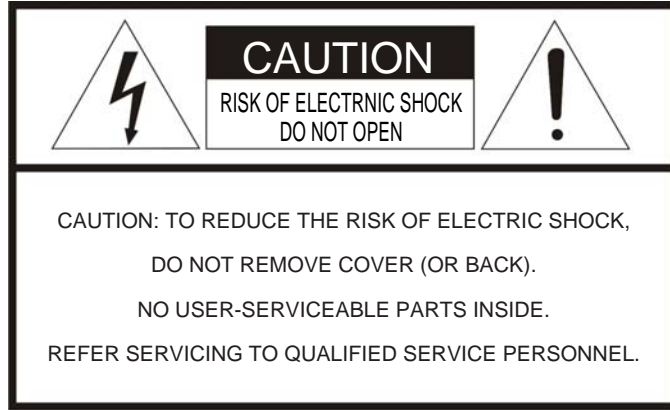

EXPLANATION OF GRAPHICAL SYMBOLS



The lightning flash with arrowhead symbol, within an equilateral triangle, is intended to alert the user to the presence of uninsulated "dangerous voltage" within the product's enclosure that may be of sufficient magnitude to constitute a risk of electric shock to persons.



The exclamation point within an equilateral triangle is intended to alert the user to the presence of important operating and maintenance (servicing) instructions in the literature accompanying the product.

PRECAUTIONS

Safety -----

Should any liquid or solid object fall into the cabinet, unplug the unit and have it checked by the qualified personnel before operating it any further.

Unplug the unit from the wall outlet if it is not going to be used for several days or more. To disconnect the cord, pull it out by the plug. Never pull the cord itself.

Allow adequate air circulation to prevent internal heat build-up. Do not place the unit on surfaces (rugs, blankets, etc.) or near materials (curtains, draperies) that may block the ventilation holes.

Height and vertical linearity controls located at the rear panel are for special adjustments by qualified personnel only.

Installation -----

Do not install the unit in an extremely hot or humid place or in a place subject to excessive dust, mechanical vibration.

The unit is not designed to be waterproof. Exposure to rain or water may damage the unit.

Cleaning -----

Clean the unit with a slightly damp soft cloth. Use a mild household detergent. Never use strong solvents such as thinner or benzene as they might damage the finish of the unit.

Retain the original carton and packing materials for safe transport of this unit in the future.

FCC COMPLIANCE STATEMENT

FCC INFORMATION: THIS EQUIPMENT HAS BEEN TESTED AND FOUND TO COMPLY WITH THE LIMITS FOR A CLASS A DIGITAL DEVICE, PURSUANT TO PART 15 OF THE FCC RULES. THESE LIMITS ARE DESIGNED TO PROVIDE REASONABLE PROTECTION AGAINST HARMFUL INTERFERENCE WHEN THE EQUIPMENT IS OPERATED IN A COMMERCIAL ENVIRONMENT. THIS EQUIPMENT GENERATES, USES, AND CAN RADIATE RADIO FREQUENCY ENERGY AND IF NOT INSTALLED AND USED IN ACCORDANCE WITH THE INSTRUCTION MANUAL, MAY CAUSE HARMFUL INTERFERENCE TO RADIO COMMUNICATIONS. OPERATION OF THIS EQUIPMENT IN A RESIDENTIAL AREA IS LIKELY TO CAUSE HARMFUL INTERFERENCE IN WHICH CASE THE USER WILL BE REQUIRED TO CORRECT THE INTERFERENCE AT HIS OWN EXPENSE.

CAUTION: CHANGES OR MODIFICATIONS NOT EXPRESSLY APPROVED BY THE PARTY RESPONSIBLE FOR COMPLIANCE COULD VOID THE USER'S AUTHORITY TO OPERATE THE EQUIPMENT.

THIS CLASS A DIGITAL APPARATUS COMPLIES WITH CANADIAN ICES-003.
CET APPAREIL NUMÉRIQUE DE LA CLASSE A EST CONFORME À LA NORME NMB-003 DU CANADA.

CE COMPLIANCE STATEMENT

WARNING

This is a Class A product. In a domestic environment this product may cause radio interference in which case the user may be required to take adequate measures.

IMPORTANT SAFEGUARDS

1. READ INSTRUCTIONS -- All the safety and operating instructions should be read before the appliance is operated.
2. RETAIN INSTRUCTIONS -- The safety and operating instructions should be retained for future reference.
3. CLEANING -- Unplug video monitor or equipment from the wall outlet before cleaning. Do not use liquid cleaners or aerosol cleaners. Use a damp cloth for cleaning.
4. ATTACHMENTS -- Do not use attachments not recommended by the video monitor or equipment manufacturer as they may result in the risk of fire, electric shock or injury to persons.
5. WATER AND MOISTURE -- Do not use video monitor or equipment near water - for example, near a bathtub, washbowl, kitchen sink, laundry tub, in a wet basement, or near a swimming pool or the like.
6. ACCESSORIES -- Do not place video monitor or equipment on an unstable cart, stand or table. The video monitor or equipment may fall causing serious injury to a child or adult and serious damage to the equipment. Wall or shelf mounting should follow the manufacturer's instructions and should use a mounting kit approved by the manufacturer.
- 6A. Video monitor or equipment and cart combinations should be moved with care. Quick stops, excessive force and uneven surfaces may cause the equipment and cart combination to overturn.
7. VENTILATION -- Slots and openings in the cabinet at the back or bottom are provided for ventilation and to ensure reliable operation of the video monitor or equipment and to protect it from overheating. These openings must not be blocked or covered. The openings should never be blocked by placing the video monitor or equipment on a bed, sofa, rug, or other similar surface. Video monitor or equipment should never be placed near or over a radiator or heat register. Video monitor or equipment should not be placed in a built-in installation such as a bookcase unless proper ventilation is provided.
8. POWER SOURCES -- Video monitor or equipment should be operated only from the type of power source indicated on the marking label. If you are not sure of the type of power supplied to your home, consult your video monitor or equipment dealer or local power company. For video monitor or equipment designed to operate from battery power refer to the operating instructions.
9. GROUNDING OR POLARIZATION -- This video monitor may be equipped with a polarized alternating - current line plug (a plug having one blade wider than the other). This plug will fit into the power outlet only one way. This is a safety feature. If you are unable to insert the plug fully into the outlet, try reversing the plug. If the plug should still fail to fit, contact your electrician to replace your obsolete outlet. Do not defeat the safety purpose of the polarized plug. Alternate Warnings - This video monitor is equipped with a three-wire grounding-type plug, a plug having a third (grounding) pin. This plug will only fit into a grounding-type power outlet. This is a safety feature. If you are unable to insert the plug into the outlet, contact your electrician to replace your obsolete outlet. Do not defeat the safety purpose of the grounding-type plug.

10. POWER CORDS -- Do not allow anything to rest on the power cord. Do not locate video monitor or equipment where the cord will be abused by persons walking on it.
11. HEED WARNINGS -- Follow all instructions marked on the video monitor or equipment.
12. LIGHTNING -- For added protection for video monitor or equipment during a lightning storm, or when it is left unattended and unused for long periods of time, unplug it from the wall outlet and disconnect the antenna or cable system. This will prevent damage to the video product due to lightning and power-line surges.
13. OVERLOADING --Do not overload wall outlets and extension cords as this can result in a risk of fire or electric shock.
14. OBJECT AND LIQUID ENTRY -- Never push objects of any kind into video monitor or equipment through openings as they may touch dangerous voltage points or short-out parts that could result in a fire or electric shock. Never spill liquid of any kind on the product.
15. SERVICING -- Do not attempt to service video monitor or equipment yourself as opening or removing covers may expose you to dangerous voltage or other hazards. Refer all servicing to qualified service personnel.
16. DAMAGE REQUIRING SERVICE -- Unplug video monitor or equipment from the wall outlet and refer servicing to qualified service personnel under the following conditions:
 - A. When the power-supply cord or the plug has been damaged.
 - B. If liquid has spilled or objects have fallen into the video product.
 - C. If the video product has been exposed to rain or water.
 - D. If the video product does not operate normally by following the operating instructions, adjust only those controls that are covered by the operating instructions as an improper adjustment of other controls may result in damage and will often require extensive work by a qualified technician to restore the video product to its normal operation.
 - E. If the video product has been dropped, or the cabinet damaged.
 - F. When the video product exhibits a distinct change in performance -- this indicates a need for service.
17. REPLACEMENT PARTS -- When replacement parts are required, be sure the service technician has used replacement parts specified by the manufacturer or that have the same characteristics as the original part. Unauthorized substitutions may result in fire, electric shock or other hazards.
18. SAFETY CHECK -- Upon completion of any service or repairs to this video product, ask the service technician to perform safety checks to determine that the video product is in proper operating condition.
19. FIELD INSTALLATION -- This installation should be made by a qualified service person and should conform to all local codes.

CONTENTS

DESCRIPTION -----	10
Key Features -----	10
Components -----	11
Camera Layout -----	12
INSTALLATION -----	14
Before Installation -----	14
Starting Installation -----	14
Base Installation -----	14
Heater Kit Installation (Optional) -----	16
Heater Power Consumption -----	16
Micro SD card Installation (Optional) -----	16
OPERATION -----	17
Minimum conditions for using web browser -----	17
Accessing the IP camera -----	17
Main Menu -----	18
LIVE VIEW -----	18
Live Video Page Icons -----	19
SETUP -----	21
Users -----	22
Network -----	25
Image -----	26
Audio -----	27
Date & Time -----	29
Live View – Source -----	31
Image – Basic -----	33
Image – AE & AWB -----	35
Image – Day & Night -----	37
Video & Image – Stream1 -----	39
Video & Image – Stream2 -----	41
Video & Image – Stream3 -----	44
Video & Image – Stream4 -----	47
Video & Image – Webcasting -----	50
Audio – Basic -----	51
Event In – Alarm-In -----	53
Event In – Manual Trigger -----	55
Event In – VMD Stream1 -----	56
Event In – VMD Stream3 -----	58
Event In – VMD Stream4 -----	60
Event Out – SMTP -----	62
Event Out – FTP& JPEG -----	64

Event Out – Audio Alert	66
Event Out – Audio Alert – Audio Recorder	67
Event Out – SD Record	69
Event Map	70
Event Map – Add	71
SD Playback – SD Playback List View	73
Security – Users	75
Security – HTTPS	78
Security – IP Filtering	80
Date & Time	81
Network – Basic	83
Network – DDNS	85
Network – RTP	86
Network – UPnP	88
Network – QoS	89
Language	90
Maintenance	91
Support	93
About	94
Technical Specifications	95
Models	95
General	95
Electrical / Connector	95
Mechanical	96
Video	97
Audio	97
System Integration	97
Environmental	97
Physical	97
Troubleshooting	98
Upgrading the Firmware	98
General Troubleshooting	98

LIST of ILLUSTRATIONS

Figure 1. Mounting Hole -----	14
Figure 2. Lock Screw -----	15
Figure 3. Mount electric box -----	15
Figure 4. Heater Kit Installation -----	16
Figure 5. Heater Power Consumption -----	16
Figure 6. Main Live View Page -----	19
Figure 7. Basic Configuration -----	21
Figure 8. Basic Configuration / Users -----	22
Figure 9. Basic Configuration / Users / Add User -----	23
Figure 10. Basic Configuration / Users / Modify User -----	24
Figure 11. Basic Configuration / Network -----	25
Figure 12. Basic Configuration / Image -----	26
Figure 13. Basic Configuration / Audio -----	27
Figure 14. Basic Configuration / Date & Time -----	29
Figure 15. Live View / Source -----	31
Figure 16. Video & Image / Image – Basic -----	33
Figure 17. Video & Image / Image – AE & AWB -----	35
Figure 18. Video & Image / Day & Night -----	37
Figure 19. Video & Image / Stream1 -----	39
Figure 20. Video & Image / Stream2 -----	41
Figure 21. Video & Image / Stream2 ROI setting -----	43
Figure 22. Video & Image / Stream3 -----	44
Figure 23. Video & Image / Stream3 ROI setting -----	46
Figure 24. Video & Image / Stream4 -----	47
Figure 25. Video & Image / Stream4 ROI setting -----	49
Figure 26 Video & Image / Webcasting -----	50
Figure 27. Audio / Basic -----	51
Figure 28. Event / Event In – Alarm In -----	53
Figure 29. Event / Event In – Manual Trigger -----	55
Figure 30. Event / Event In – VMD Stream1 -----	56
Figure 31. Event / Event In – VMD Stream3 -----	58
Figure 32. Event / Event In – VMD Stream4 -----	60
Figure 33. Event / Event Out – SMTP (Email) -----	62
Figure 34. Event / Event Out – FTP & JPEG -----	64
Figure 35. Event / Event Out – Audio Alert -----	66
Figure 36. Event / Event Out – Audio Alert / Audio Recorder-----	67
Figure 37. Event / Event Out – Audio Alert / ARecorder window -----	67
Figure 38. Event / Event Out – Audio Alert / Encode setup -----	68
Figure 39. Event / Event Out – SD Record -----	69
Figure 40. Event / Event Map -----	70
Figure 41. Event / Event Map – Add -----	71
Figure 42. SD Playback / Playback List View-----	73
Figure 43. SD Playback / Playback List View – Playback-----	74
Figure 44. System / Security – Users -----	75

Figure 45. System / Security – Users / Add User -----	76
Figure 46. System / Security – Users / Modify User -----	77
Figure 47. System / Security – HTTPS -----	78
Figure 48. System / Security – IP Filtering -----	80
Figure 49. System / Date & Time -----	81
Figure 50. System / Network – Basic -----	82
Figure 51. System / Network – DDNS -----	85
Figure 52. System / Network – RTP -----	86
Figure 53. System / Network – UPnP -----	88
Figure 54. System / Network – QoS -----	89
Figure 55. System / Language -----	90
Figure 56. System / Maintenance -----	91
Figure 57. System / Support -----	93
Figure 58. About -----	94

DESCRIPTION

The NXD Series camera is an internet protocol based megapixel network camera with a built-in web based viewer on Internet Explorer®. The camera has a connection feature for third-party applications and compatible with supplied Utility software for easy installation and Client software to search, configure, manage, live view, record and playback.

The camera supports dual compression formats and multiple streaming simultaneously. The two standard compression formats include H.264 and MJPEG. The multiple streams can be configured to a variety of resolutions, bit rates and frame rates.

The camera uses 1/2.5 inch CMOS sensor and Focal length 3~9mm lens and also supports PoE (Power over Ethernet), DC12V, and AC24V.

Models

NXD-1401M	NXD Series, 1 Megapixel, 30ips@1280x720
NXD-1402M	NXD Series, 2 Megapixel, 15ips@1600x1200
NXD-1301M	NXD Series, 1 Megapixel, 30ips@1280x720, Day/Night
NXD-1302M	NXD Series, 2 Megapixel, 15ips@1600x1200, Day/Night

Key Features

- HDTV Video Quality

The NXD Series are capable of providing the outstanding image quality with HDTV performance and profiles (High, Main, and Baseline) in H.264 compression.

- Multiple Streaming

Each stream can be programmed independently and transmitted using different configurations.

- ROI (Region of Interest)

ROI features that transmit specially selected area in the primary stream using different FPS, Resolution, Bit Rates and Picture Quality.

- Easy Focus

Easy Focus helps to reduce the installation efforts especially video image focusing of the camera.

- Dual Codec (H.264, MJPEG)

The NXD Series supports two standard compressions formats H.264 and MJPEG.

- Digital PTZ

Supports maximum 10x digital zoom.

- Intelligent Video Motion Detection

The NXD Series offers intelligent & sophisticated video motion detection for each multiple streams.

- Triple Power (Power over Ethernet, DC12V, AC24V)

This camera supports Power over Ethernet (PoE), which supplies power to the camera through the network. If the network has no PoE, connect a DC12V or AC24V power connector.

- Day and Night

The NXD Series provide clear monitoring images even in low light conditions using IR-cut filter.

- SD Local Recording

The NXD Series provides local video recording function. When camera detects video motion or alarm events or manual trigger, it can record video stream by itself.

- Voice Alert Linked to Alarm Detection

The NXD Series can play the audio file stored in the camera in synchronization with alarm detection by the sensor input or the motion detection function.

- Network Flow Control

The NXD Series provides a flow control function which enhances network efficiency by significantly restricting user video streams with designating the maximum bandwidth.

- ONVIF Certificate

The NXD Series network camera complies with the ONVIF certificate. ONVIF (Open Network Video Interface Forum) is an open industry forum for the development of a global standard for the interface of network video products.

Components

Quantity	Description
1	Camera
1	Installation CD
1	Accessory kit for installing Dome Camera
1	Template sheet
1	Extension connector kit

NOTE

Adapter for DC12V / AC24V are not supplied.

Camera Layout

Top View

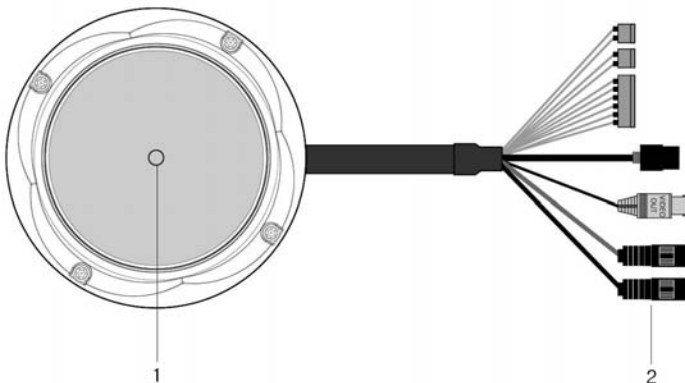

- 1 **Lens:** Allows wide area to be monitored
- 2 **Connection Cable:** 26pin camera extension cable

Connection Cable

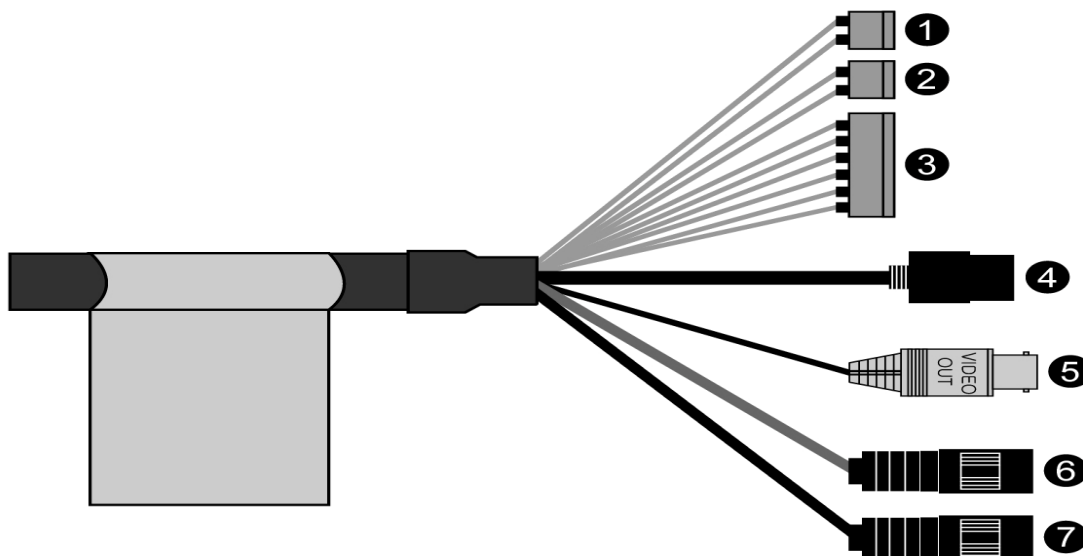

- 1 **Main POWER connection**
 - **RED;** DC12V or AC24V
 - **WHITE;** GND or AC24V
- 2 **Heater POWER connection (Optional)**
 - **ORANGE;** DC12V or AC24V
 - **BLACK;** GND or AC24V
- 3 **ALARM connection**
 - **PINK;** Alarm Input 1

- **GREEN**; GND
- **YELLOW**; Alarm Input 2
- **BROWN**; GND
- **Light BLUE**; Alarm Out
- **GRAY**; GND

4 **RJ-45 connection:** Connect Ethernet cable or supplies power to the camera if PoE is available.

5 **BNC connection:** Connect BNC cable for composite video output.

6 **SPEAKER connection (GRAY):** Connect external speaker for audio output.

7 **MIC connection (BLACK):** Supplies external microphone as an audio input source.

INSTALLATION

Before Installation

Before installing the camera, thoroughly familiarize yourself with the information in this section of the manual.

- Recommends connecting the camera to a network that use a DHCP (Dynamic Host Configuration Protocol) server to address devices.
- To ensure secure access to the IP camera, place the camera behind a firewall when it is connected to a network.

Starting Installation

Base Installation

1. Make mounting holes and cable hole in the place (ceiling) to which this dome camera is installed using the supplied template sheet.

NOTE

The total mass of the main unit is approx 1.3kg. Check whether the ceiling to which the Dome Camera is installed is strong enough to hold the unit mass. If not, the Dome Camera could fall, causing injury.

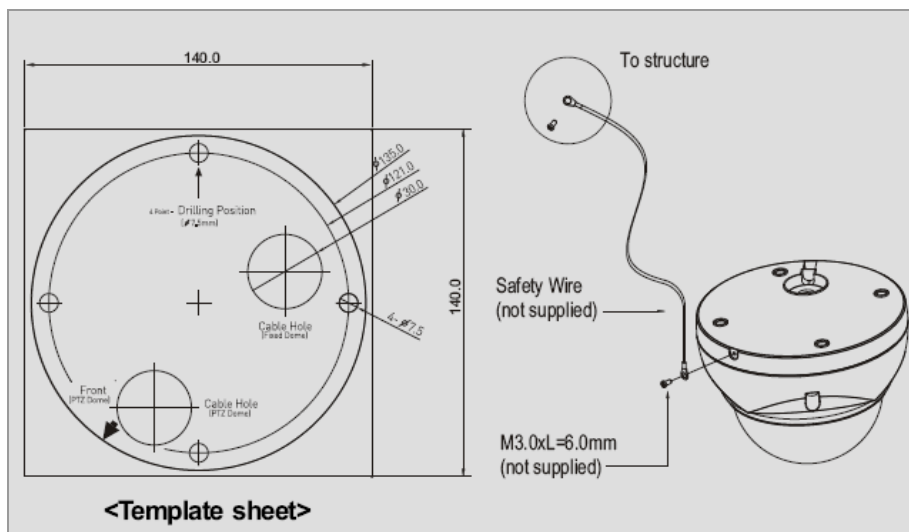

Figure 1. Mounting Hole

2. Attach the safety wire for securing the dome camera to ceiling or structure not to fall.
3. Extract each wire through the cable hole, connect BNC cable and communication lines.

4. Unlock torx screws (4x) the dome cover and fix the dome case firmly with supplied mounting screws (4x), plastic anchors (4x), O-Rings (4x).
5. Adjust desired focus and scene by turning and moving the hemisphere by hand.
6. Lock the housing cover with torx screws (4x).

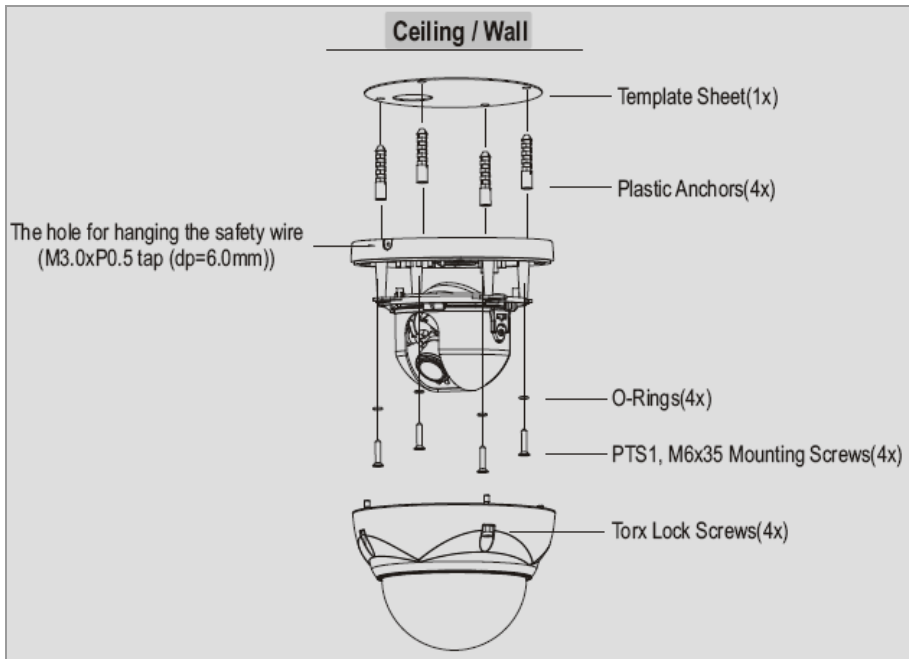

Figure 2. Lock Screw

NOTES

- Cable through the electrical box with the dome base
The housing can also be mounted on a 4s or 2s electrical box.
- Using the conduit knockout punched with the dome base
Remove the conduit knockout punched for the cable entry.

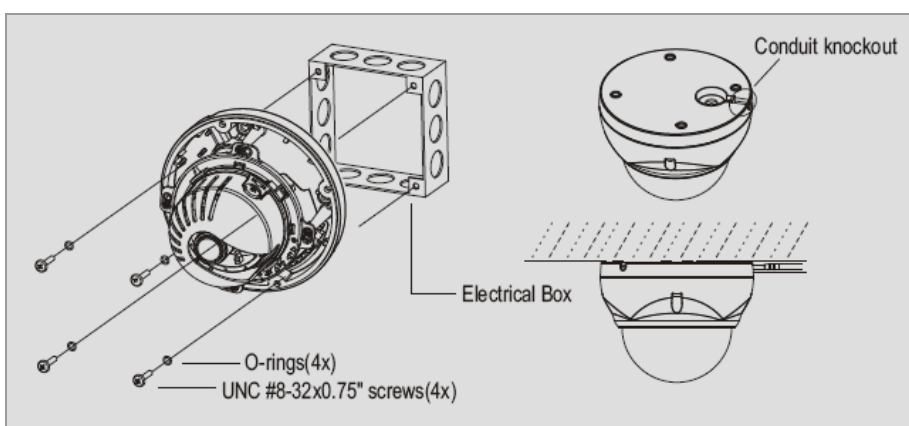

Figure 3. Mount electric box

Heater Kit Installation (Optional)

1. Place the heater element in slot "A". Please ensure that the cables are facing upwards and the heater is pointing towards the Dome.
2. Place the PCB in slot "B". Please ensure that the PCB is facing inside of the Dome with the connection blocks at the top.
3. Place the plug in the Socket "C" (J3) which is found on the controller board.

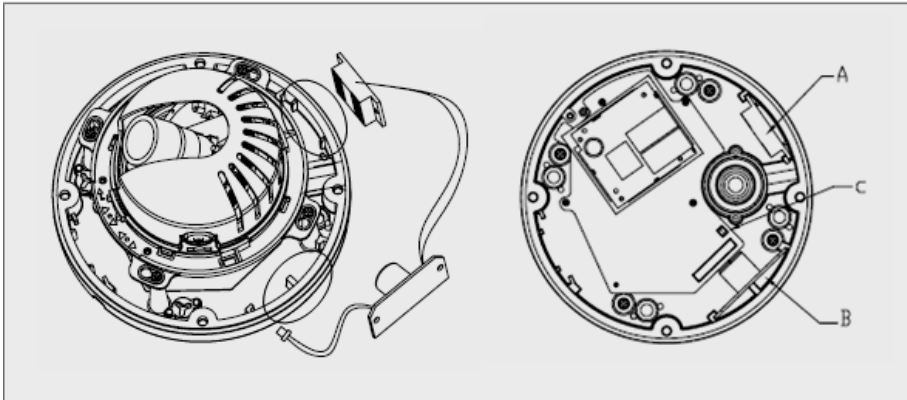

Figure 4. Heater Kit Installation

NOTES

- Heater power consumption

Power Supply	AC24V	DC12V
Power Consumption	20Watt	10Watt
Heater On	at 41°F (5°C)	
Heater Off	at 59°F (15°C)	

Figure 5. Heater Power Consumption

- Power

Use Certified/Listed Class 2 power source only.

Micro SD Card Installation (Optional)

1. First, open the housing cover and then check the SW2 mode whether SW2 is at off mode or not. The default setting is off mode.
2. Insert micro SD card and then move SW2 direction to on.
3. In case of SD card removal, first move SW2 direction to off mode and then remove SD card.

OPERATION

Before starting the camera, installation must be complete. The camera completes a configuration sequence within approximately 40 seconds when power is supplied. The amber LED of this megapixel camera flash one time per second indicating the configuration sequence is complete.

NOTES

- If the DHCP is enabled but the camera is not connected to a DHCP server, the camera will be set default IP 192.168.30.220 and try to get IP from DHCP server about every two seconds.
- Network and processor bandwidth limitations might cause the video stream to pause or appear pixilated when an increased number of Web-interface users connection to the camera. Decrease the images per second, resolution, compression, or bit rate settings of the Web-interface video streams to compensate for network or processor limitations.

Minimum conditions for using web browser

The minimum system requirements to use a Web browser with this IP camera are as follows:

- CPU: Pentium® 4 microprocessor, 2.0GHz
- Operational System: Windows XP® or Windows Vista® or Windows7®
- System Memory: RAM 512 Mbyte
- Ethernet: 100 Mbit
- Video Resolution: 1024(Horizontal) x 768(Vertical) pixels or higher
- Internet Explorer® 7 or later
- ActiveX® 1.0.0.13 or later

Accessing the IP camera

1. Open Web browser
 - Double click Internet Explorer® icon.
2. Type IP address
 - Type the camera's IP address in the Internet Explorer® address bar.
 - The default IP address is **192.168.30.220**

NOTES

- If you do not know the camera's IP address, install the SmartManager® utility software available on the CD supplied with the product. The utility software will locate the assigned Model name, Host name, MAC address, IP address, Version and others.
- Refer to the SmartManager® utility software manual for more detail.

3. Log On to the camera

- Click the Live View icon for default live image view or the Setup icon to change the configuration values.

Main Menu

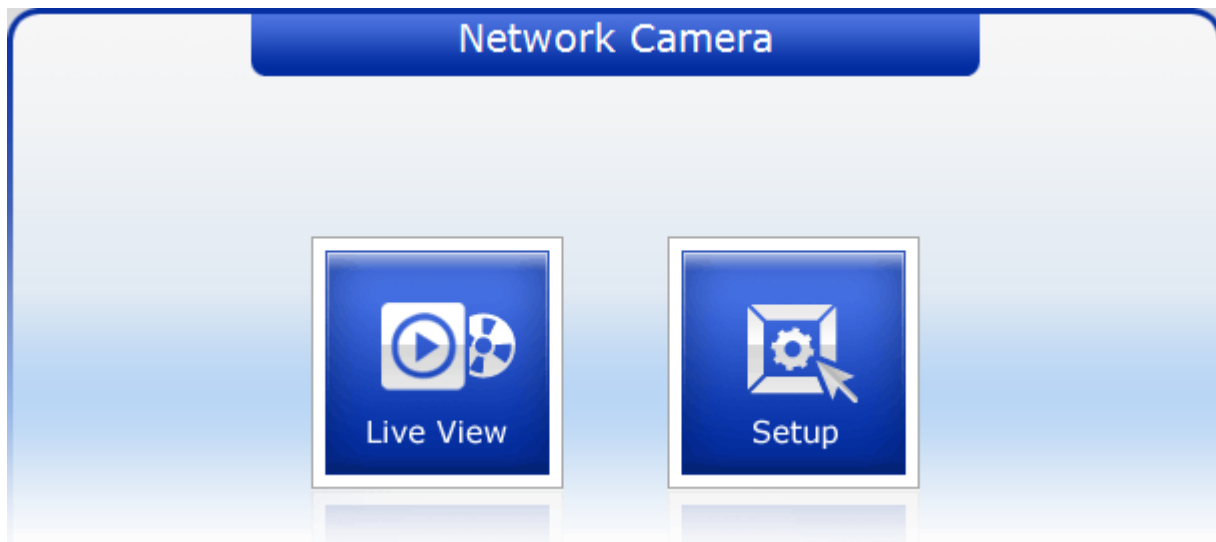

Figure 5. Main menu

The dialog box will be appears.

- Type User ID and Password in the dialog box. The default User ID and Password is ***admin***.

NOTE

For security purposes, be sure to change the password after you log on for the first time.

LIVE VIEW

The Live View page provides you to select the properties of video source. You can view the live image from this page and also access the Setup menu and operate the main functions.

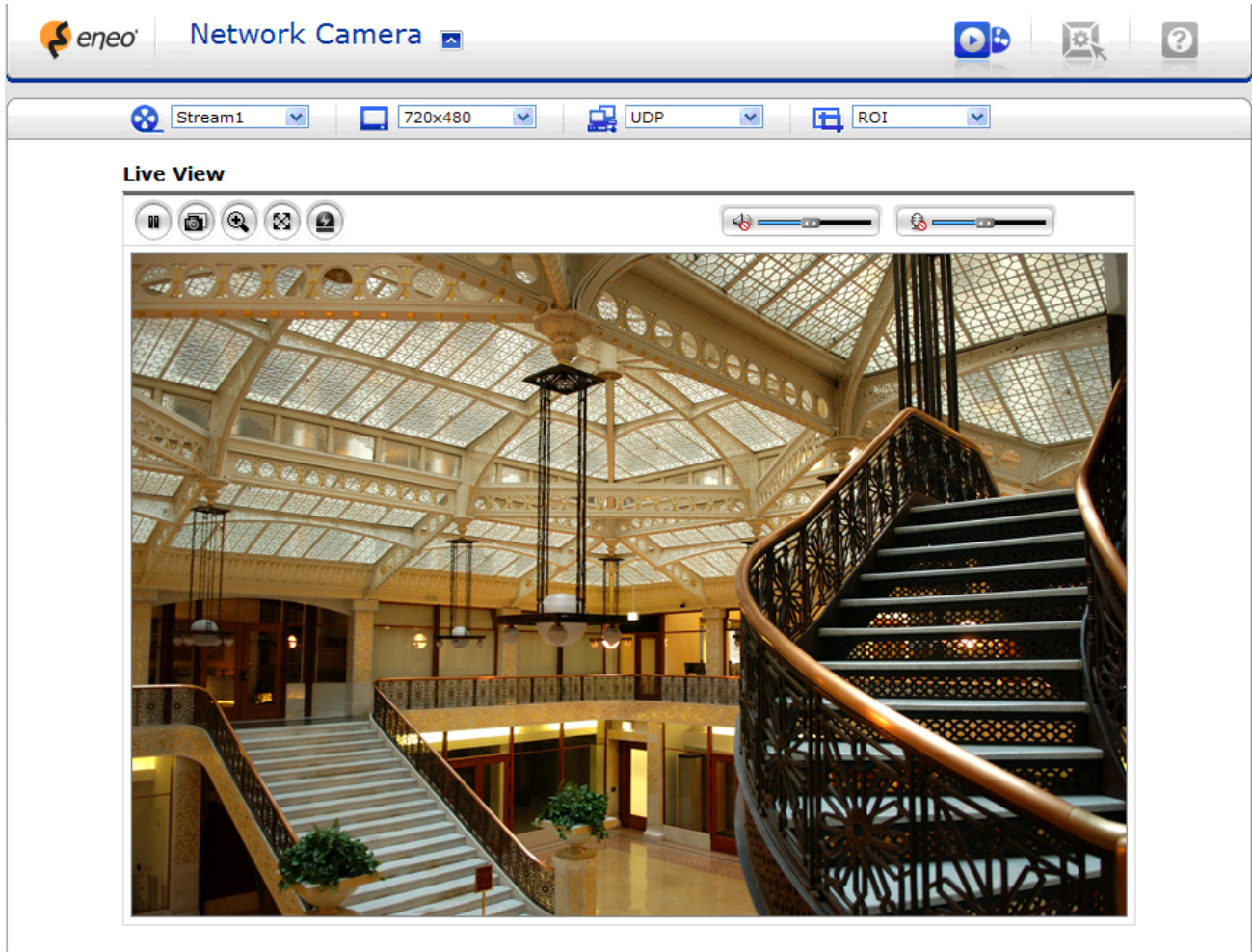













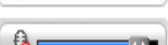

Figure 6. Main Live View Page

Live Video Page Icons

- Hide Main Icons: Hides main icons in the live view page.
- Show Main Icons: Shows main icons in the live view page.
-  Live view: Displays live video stream.
-  Setup: Enters setup menu.
-  Help: Shows helpful information.

-  Source: Specify the viewable video stream source to display in live view page.
-  View Size: Specify the viewable video size to display in live view page.
-  Stream Type: Specify the internet protocol to display in live view page.
-  ROI View: Specify the specially selected area to transfer using different stream feature in the primary video image. ROI is an abbreviation for "Region of Interest".

-  Pause: Pause the live video stream.
-  Snapshot: Take a picture of the video image currently on display. Supports the origin image size view, Print, and Save feature.
-  Digital Zoom: Supports a digital zoom in live video image.
-  Full Screen: Expands video image to the entire screen area.
-  Manual Trigger: Activates the Alarm Out signaling manually.
-  Speaker: Adjusts the volume of Speaker and switch the sound on / off.
-  Microphone: Adjusts the volume of Microphone and switch the sound on / off.

SETUP

The SETUP pages provide you to manage the camera and change the setting values. For the easy and quick access the video, the setup menu is configured two parts, which are Basic Configuration and advanced configuration. The Basic Configuration menu allows you to setup Users, basic Network and Image. The remaining configuration parts help to setup user dependent values and provide more advanced settings.

Basic Configuration

Basic Configuration supply user to access the camera image using minimum setting. Also it shows the camera basic information such as Model name, Firmware version and MAC address.

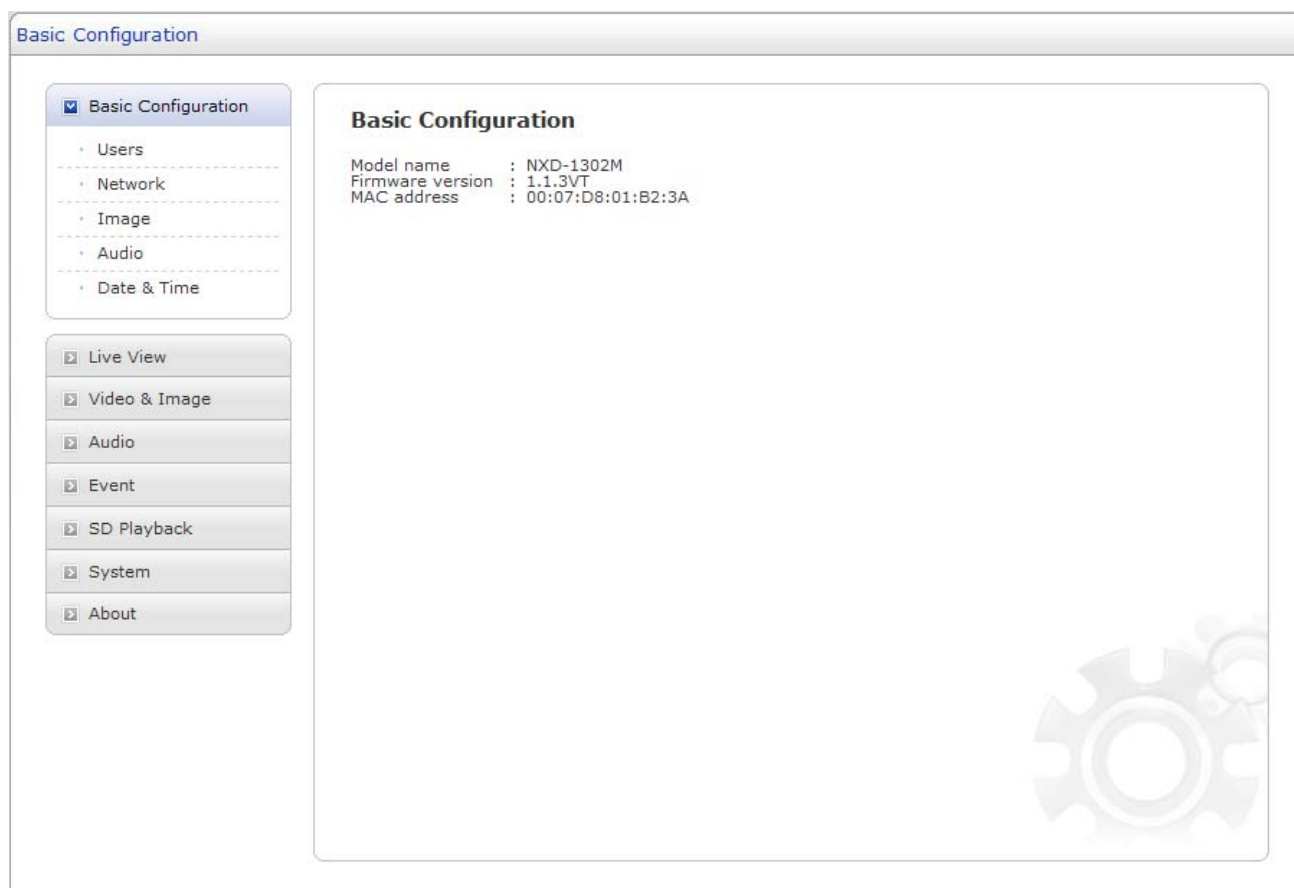

Figure 7. Basic Configuration

NOTE

The setting menu might not be available if the user does not have the permission to access this feature. The only required setting is the IP address, which is set on the Network page. All other settings are available with default values and optional.

Users

Use the Users tab to manage user permission to access the camera.

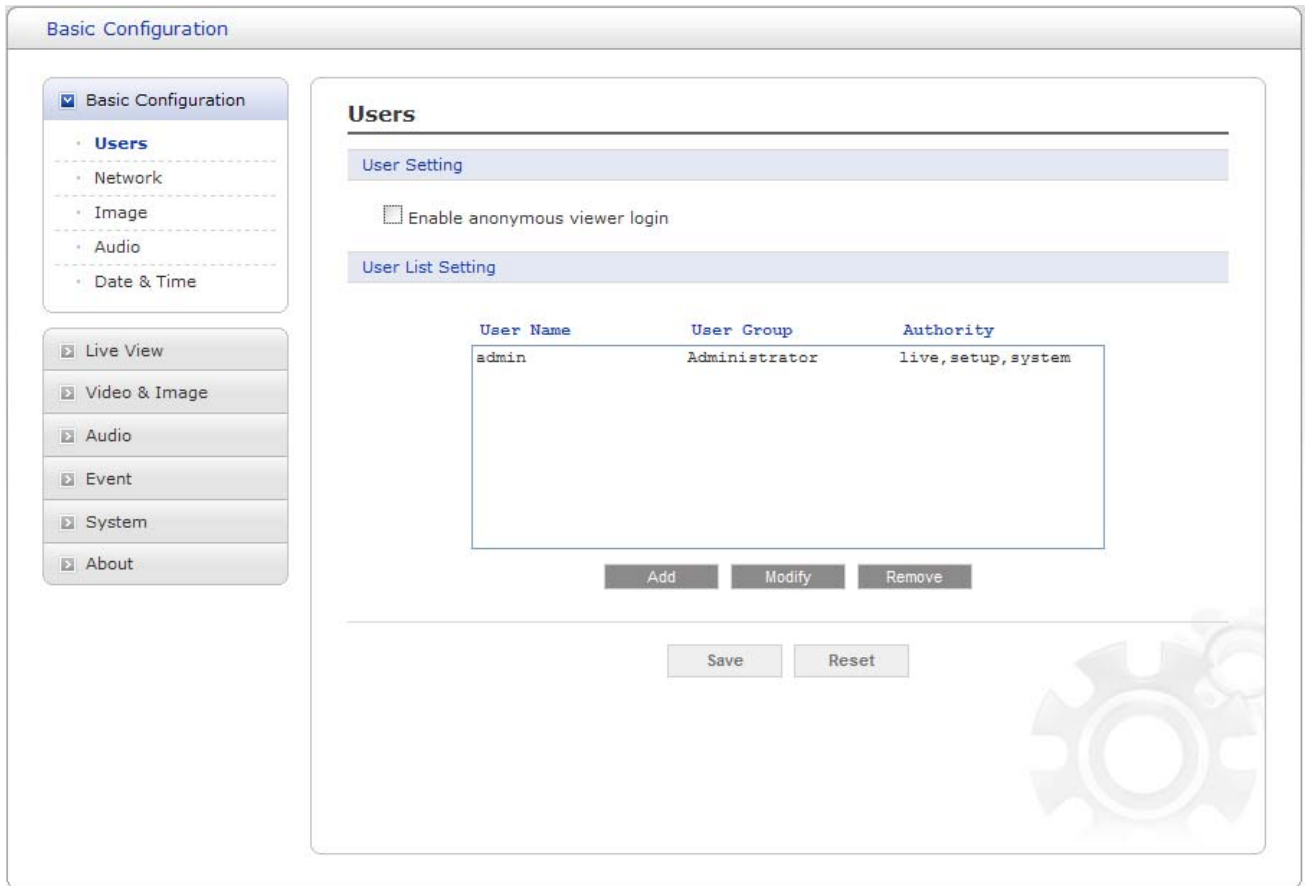

Figure 8. Basic Configuration / Users

User Setting: Click the Enable anonymous viewer login checkbox to enable anonymous user login to the camera. The default setting is disabled.

User List Setting: User accounts can be added or modified or removed. The authority depends upon user group automatically and shows the permission status to access the menus. The default user name / password is **admin**.

User Name: Shows the name which registered to access the camera.

User Group: Shows the assigned permission given to users.

Authority: Shows the permission status to access the menus.

- Click the Add, Modify, or Remove button for managing user account.

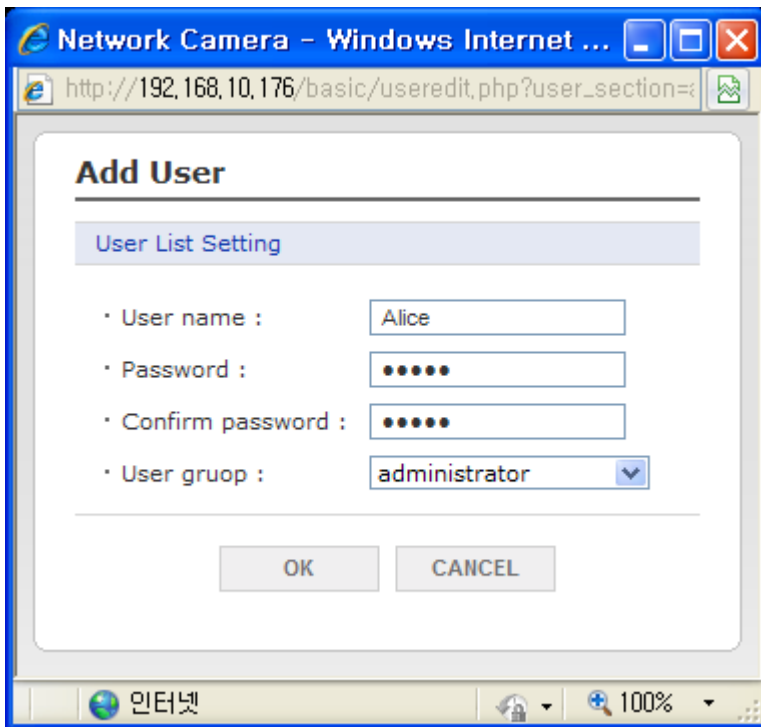

Figure 9. Basic Configuration / Users / Add User

To add a new user:

1. Click the Add tab, and then new pop-up window appears.
2. Click in the User name box and type a new user name (1 to 14 alphanumeric characters). User names are not case sensitive.
3. Click in the Password box and type a password (1 to 8 alphanumeric characters). Passwords are case sensitive.
4. Click in the Confirm password box and retype a password.
5. Click in the User group box and select one of the groups you wish to assign to the user.
6. Click the OK button to save the settings and add a new user.

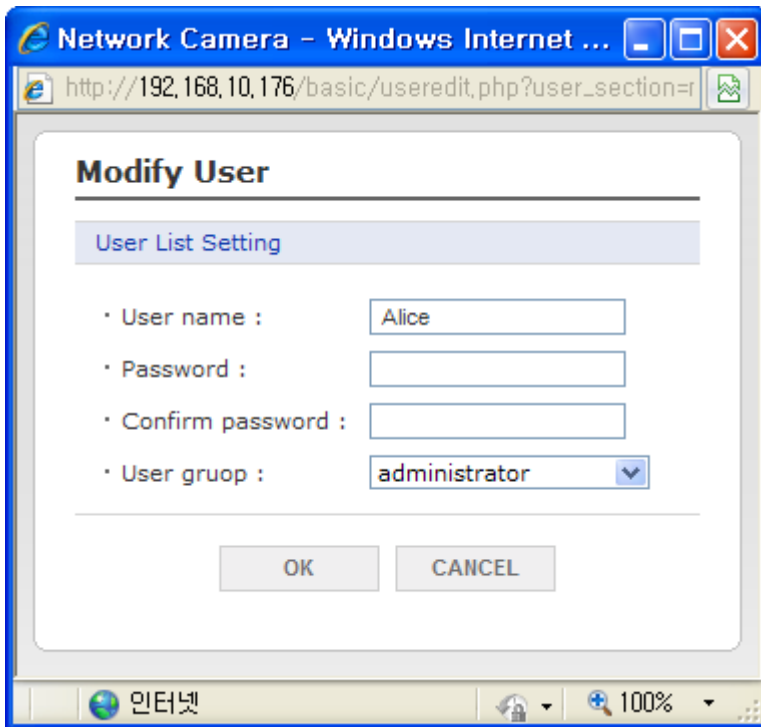

Figure 10. Basic Configuration / Users / Modify User

To modify a user:

1. Select one of the User Name in the User List Setting you want to modify.
2. Click the Modify tab, and then new pop-up window appears.
3. Click in the Password box and type a password (1 to 8 alphanumeric characters). Passwords are case sensitive.
4. Click in the Confirm password box and retype a password.
5. Click in the User group box and select one of the groups you wish to assign to the user.
6. Click the OK button to save the settings and modify a user.

NOTE

The user name can't be modified.

To remove a user:

1. Select one of the User Name in the User List Setting you want to remove.
2. Click the Remove tab. A dialog box appears with confirmation message.
3. Click the OK button. The user profile is removed from the User List Setting profile.

NOTE

The admin user name can't be modified.

- Click the Save button to save the settings, or click the Reset button to clear all of the information you entered without saving it.

Network

Use the Network tab to manage basic network settings.

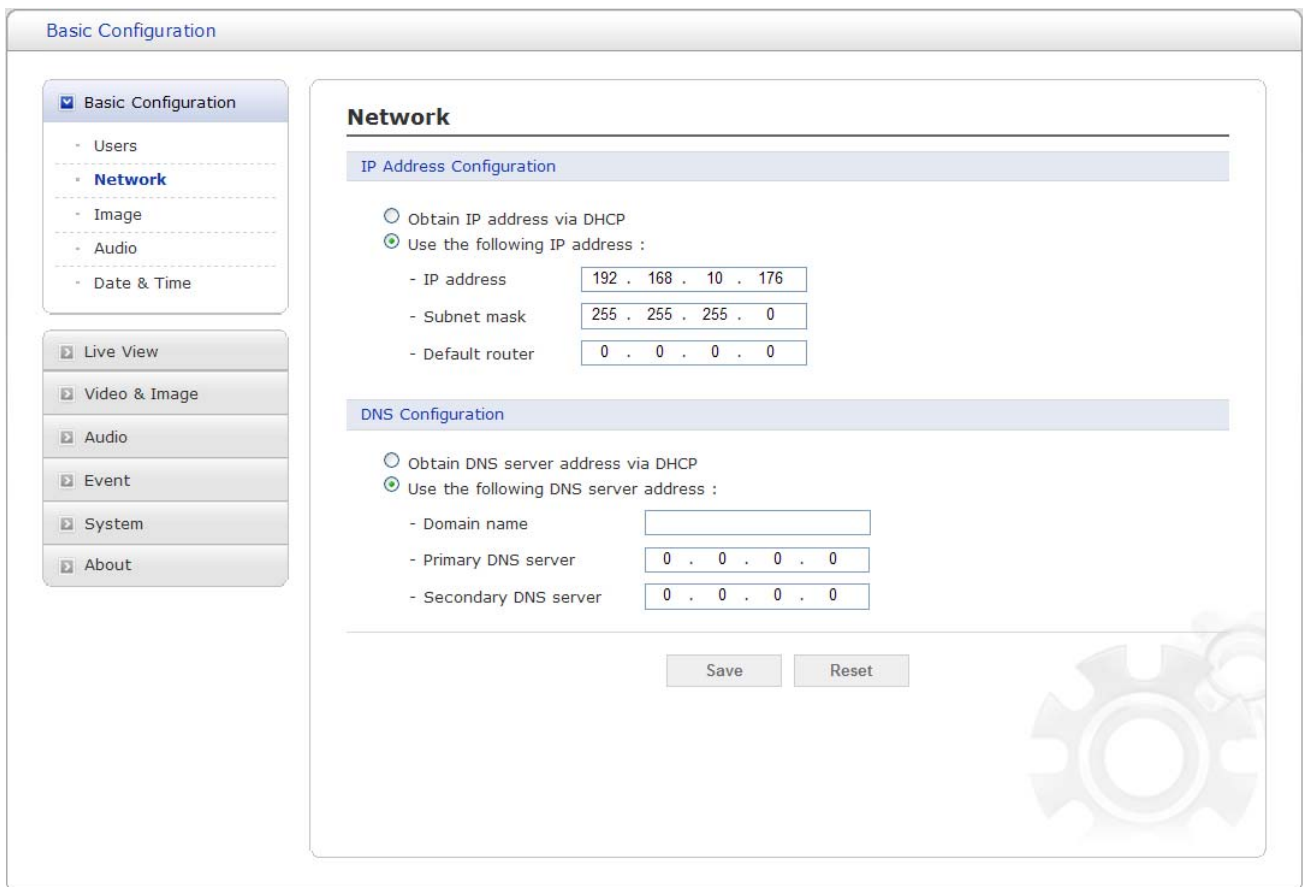

Figure 11. Basic Configuration / Network

IP Address Configuration: The DHCP (Dynamic Host Configuration Protocol) server has a feature that automatically assigns an IP address to the device if there is a device on the network.

Obtain IP address via DHCP: Select the checkbox if you want to assign the IP address from DHCP server automatically, and then the remaining settings are read-only text.

Use the following IP address: Select the choice box if you want to assign the IP address manually.

IP address: The address of the camera connected to the network. Specify a unique IP address for this network camera.

Subnet mask: The address that determines the IP network that the camera is connected to (relative to its address). Specify the mask for the subnet the network camera is located on.

Default router: The router that accesses other networks. Specify the IP address of the default router (Gateway) used for connecting devices attached to different networks and network segments.

DNS Configuration: DNS (Domain Name Service) provides the translation of host names to IP addresses on your network.

Obtain DNS server via DHCP: Select the choice box if you want to use the DNS server settings provided by the DHCP server automatically, and then the remaining settings are read-only text.

Use the following DNS server address: Select the choice box if you want to use the desired DNS server manually.

Domain name: Enter the domain to search for the host name used by the network camera.

Primary DNS server: Enter the IP address of the primary DNS server.

Secondary DNS server: Enter the IP address of the secondary DNS server.

- Click the Save button to save the settings, or click the Reset button to clear all of the information you entered without saving it.

Image

Use the Image tab to adjust the camera image setting value and orientation.

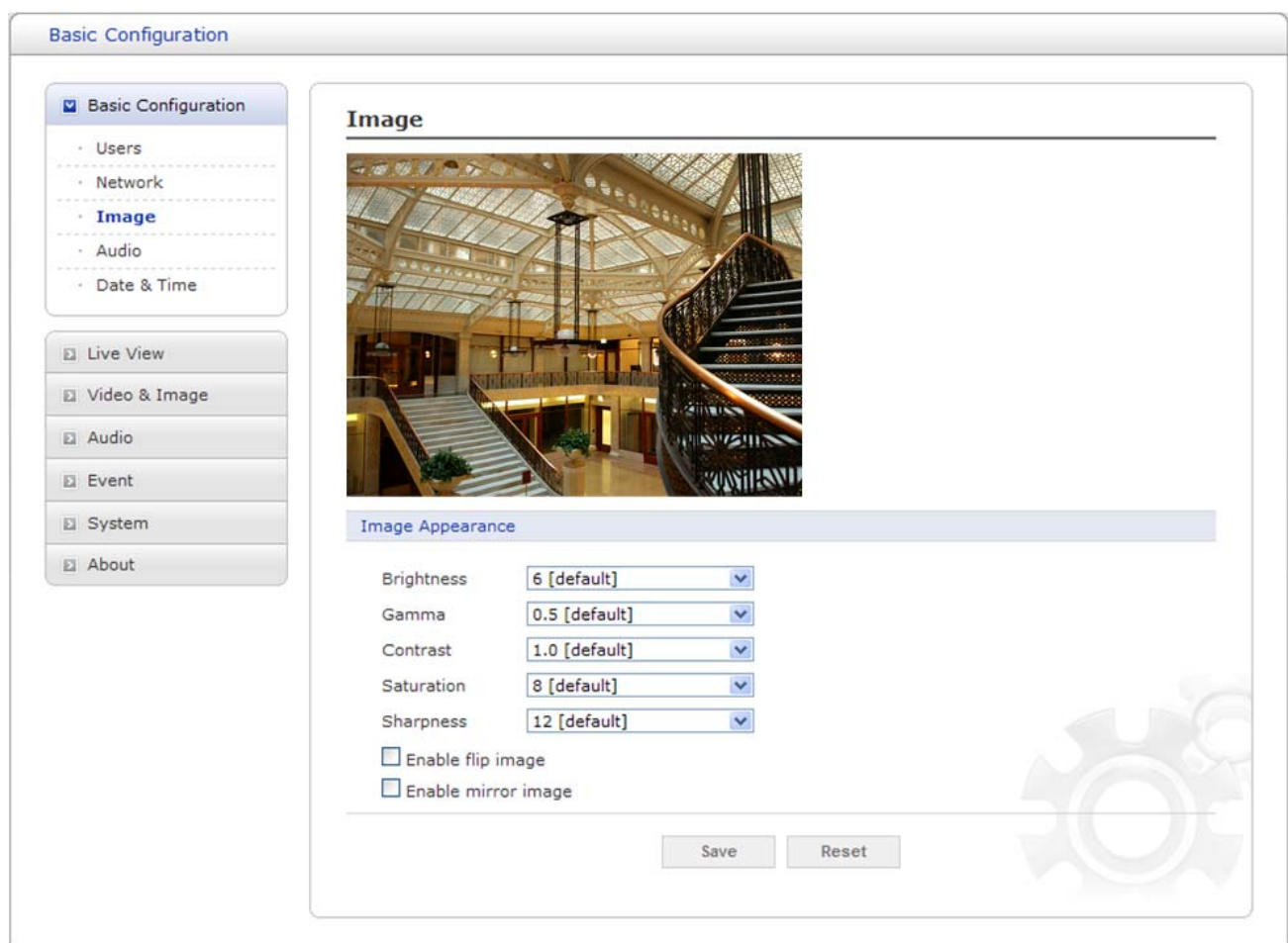

Figure 12. Basic Configuration / Image

Image Appearance: The image appearance allows you to adjust the camera setting parameters and change the camera orientation. All of parameters are recommended to be modifying for good image quality suitable for installation place.

Brightness: The image brightness can be adjusted in the range 0-20, where a higher value produces a brighter image. The default setting is 6.

Gamma: Adjusts the details in the light and dark areas of the scene. Gamma can be adjusted in the range 0.2-1.2, where a lower value expose more detail in the light area of the scene and a higher value expose more detail in the dark area of the scene. The default setting is 0.5.

Contrast: Controls the gradations between the darkness and lightest portions of the scene. The contrast can be adjusted in the range 1.0-2.0. The default setting is 1.0.

Saturation: Controls how intense or vivid the colors are in a scene. The saturation can be adjusted in the range 0-16. The default setting is 8.

Sharpness: Controls the clarity of detail in a scene. The sharpness can be adjusted in the range 0-20. The default setting is 12.

Enable flip image: Rotate the camera image 180 degrees vertically.

Enable mirror image: Creates a mirror image by rotating the camera image 180 degrees horizontally.

- Click the Save button to save the settings, or click the Reset button to clear all of the information you entered without saving it.

Audio

Use the Audio tab to manage the basic audio settings for the camera.

Basic Configuration

- Basic Configuration
- Users
- Network
- Image
- Audio
- Date & Time

- Live View
- Video & Image
- Audio
- Event
- System
- About

Audio

Audio Setting

Enable audio

- Compression type: G.711 u-law

- Sample rate: 8 kHz

Audio Input

Input volume: 0.00 dB Mute

Audio Output

Output volume: 0.0 dB Mute

Save Reset

Figure 13. Basic Configuration / Audio

Audio Setting: Click the Enable audio checkbox to enable audio. This page describes how to configure the basic audio settings for the camera. This camera supports the audio full duplex that can be transmits and receives audio in both directions at a time.

Compression type: G.711 is the international standard for encoding wired-telephone audio on 64kBit/s channel. It is a PCM (Pulse Code Modulation) scheme operating at 8 kHz sample rate. The default setting is G.711 μ -law.

Sample rate: Indicates the number of times per second the sound is sampled. The default setting is 8 kHz.

NOTE

G.711, also known as Pulse Code Modulation (PCM), is a very commonly used waveform codec. G.711 uses a sampling rate of 8,000 samples per second, with the tolerance on that rate 50 parts per million (ppm). Non-uniform quantization (logarithmic) with 8 bits is used to represent each sample, resulting in a 64 kbit/s bit rate. There are two slightly different versions; μ -law, which is used primarily in North America, and A-law, which is in use in most other countries outside North America. G.711 μ -law tends to give more resolution to higher range signals while G.711 A-law provides more quantization levels at lower signal levels.

Audio Input: Adjusts the audio volume especially from the Mike.

Input volume: The Input volume can be adjusted in the range from -21.00 to 21.00 dB. The default setting is 0 dB. Click the Mute box if you do not want the audio input.

Audio Output: Adjusts the audio volume especially to the Speaker.

Output volume: The Output volume can be adjusted in the range from -18.1 to 6.0 dB. The default setting is 0 dB. Click the Mute box if you do not want the audio output.

- Click the Save button to save the settings, or click the Reset button to clear all of the information you entered without saving it.

Date & Time

Use the Date and Time tab to set the camera's date and time values, manually or automatically.

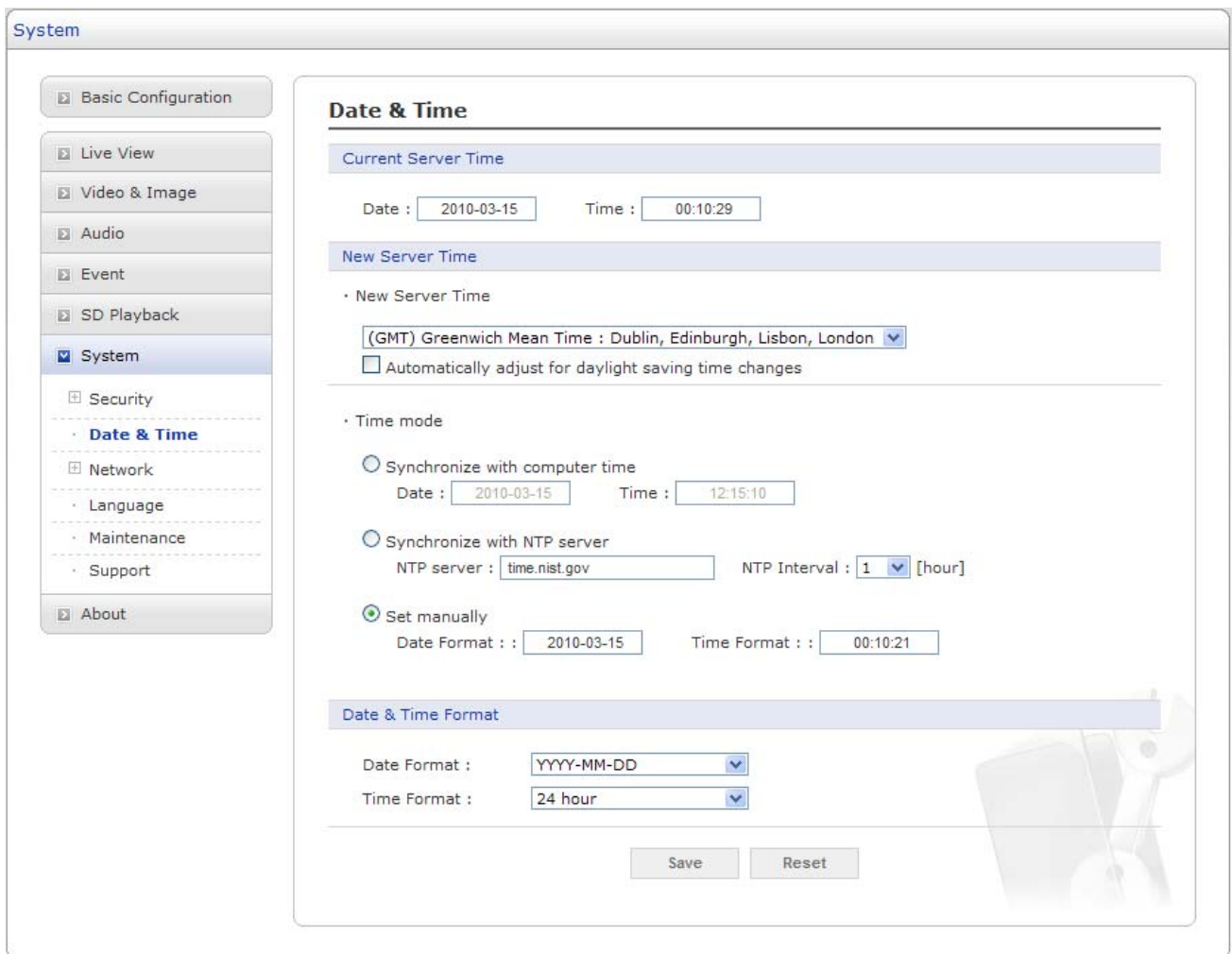

Figure 14. System / Date & Time

Current Server Time: Shows the current date and time.

Date: The default setting is 1970-01-01.

Time: The default setting is 00:00:00.

New Server Time: Select the time zone where your camera is located.

Click the Automatically adjust for daylight saving changes checkbox to automatically update the time changes caused by daylight saving.

Time zone: The default setting is GMT.

Time mode: The default setting is Set manually.

Synchronize with computer time: Sets the time according to the clock on your computer.

Synchronize with NTP Server: This option will obtain the correct time from an NTP server every 60 minutes. The NTP server's IP address or host name is specified in the time server.

Set manually: Using this option allows you to manually enter the date and time.

Date & Time Format: Select one of the Date and Time format.

Date Format: The default setting is YYYY-MM-DD.

Time Format: The default setting is 24 hours.

- Click the Save button to save the settings, or click the Reset button to clear all of the information you entered without saving it.

Live View

Use the Source tab to configure the live view video source and composite video output properties.

Source

Configure the default live view source in the web browser and composite video output source.

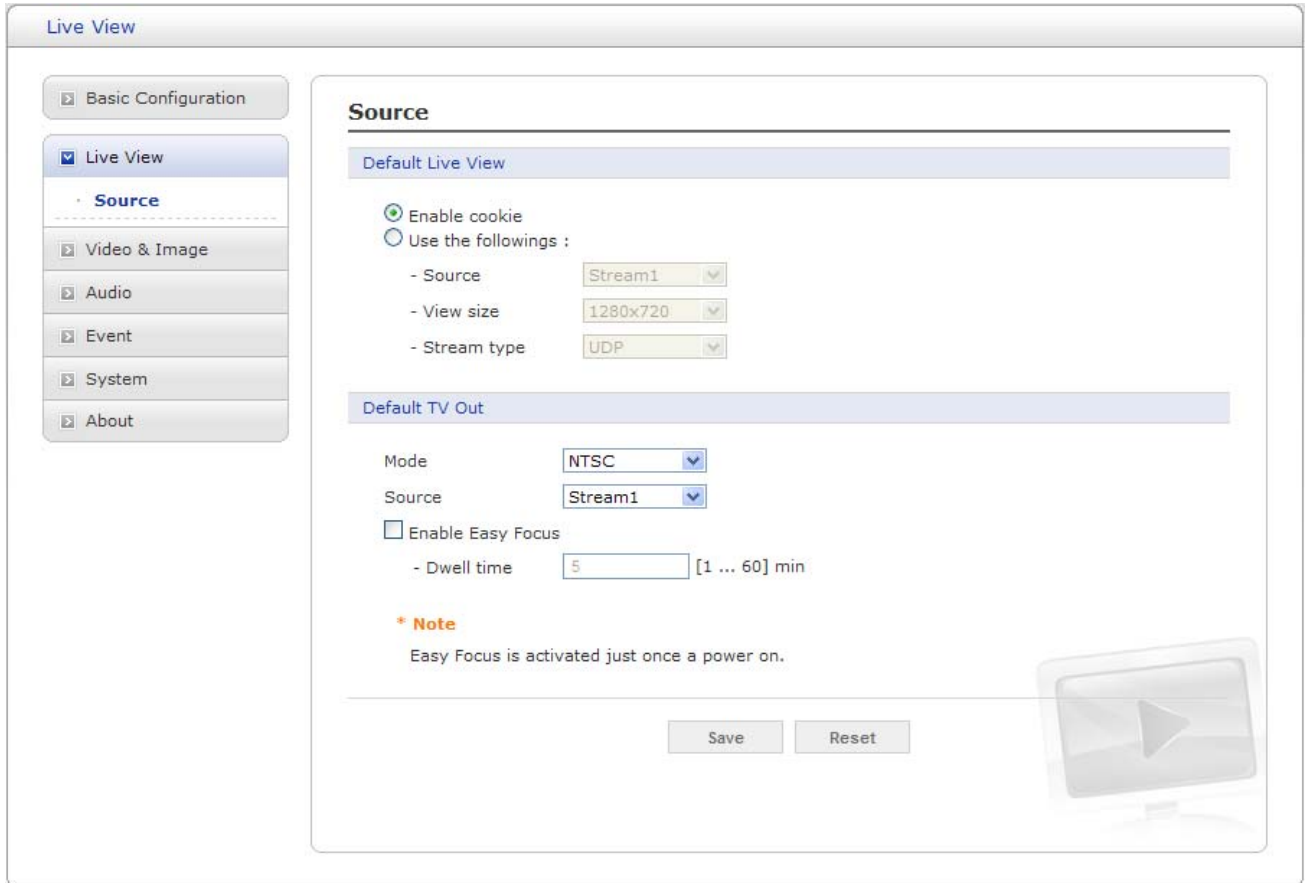

Figure 15. Live View / Source

Default Live View: Select which formats do you want as default live view source.

Enable cookie: Click the Enable cookie box if you want to reload the last configuration settings.

Use the followings: Click the Use the following box to configure the video properties to be displayed in the live view page.

Source: Select one of the stream sources to be displayed in the live view page. The default setting is Stream1.

View size: Select one of the view sizes to be displayed in the live view page. The default setting is a 1280x720.

Stream type: Select one of the stream protocols. The default setting is UDP.

Default TV out: Configure the composite video output properties.

Mode: Select the composite video output format. The default setting is NTSC.

Source: Select one of the composite video output sources. The default setting is stream1.

-- **Quad:** If you select Quad, the composite video output displays the different four video images on a single video pane based ROI settings.

NOTES

- To be possible Quad function, you need to configure the ROI (Region of Interest) first, which is supplied you as a video source.

- If the stream1 is set a 1600x1200, the first quad window will be displayed as cropped resolution max.480x360 at aspect ratio 4:3 or max.544x306 at aspect ratio 16:9.

-- **Sequence:** If you select Sequence, the composite video output repeats the video images on a single video pane according to <Sequence Mode Setting>.

<Sequence Mode Setting>

Click the checkbox if you want to assign each stream into Sequence Mode.

Each stream dwell time shows the dwelling time / intervals of each stream when the stream set the sequence mode.

-- **Stream1 Dwell Time:** Enter stream1 dwell time. The dwell time can be adjusted in the range 3-3600 seconds. The default setting is 5 seconds.

-- **Stream2 Dwell Time:** Enter stream2 dwell time. The dwell time can be adjusted in the range 3-3600 seconds. The default setting is 5 seconds.

-- **Stream3 Dwell Time:** Enter stream3 dwell time. The dwell time can be adjusted in the range 3-3600 seconds. The default setting is 5 seconds.

-- **Stream4 Dwell Time:** Enter stream4 dwell time. The dwell time can be adjusted in the range 3-3600 seconds. The default setting is 5 seconds.

-- **Quad Dwell Time:** Enter quad mode dwell time. The dwell time can be adjusted in the range 3-3600 seconds. The default setting is 5 seconds.

Enable Easy Focus: Click the Enable Easy Focus checkbox if you want to active the composite output on Easy Focus mode. The Easy Focus function helps to reduce the installation efforts especially video image focusing of the camera. If Easy Focus is active, the new popup window will appears at the right corner of the center pane. From that window you can easily focus the camera.

Dwell time: Enter Easy Focus dwell time. The dwell time can be adjusted in the range 1-60 minutes. The default setting is 5 minutes. If the dwell time is expired, the composite video output will be back with normal video output mode.

NOTES

- The stream1 is only available stream source in Easy Focus mode.

- While Easy Focus dwell time, the stream1 is only transmitted, the other streams do not transmit.

- Click the Save button to save the settings, or click the Reset button to clear all of the information you entered without saving it.

Video & Image

Use the Video & Image tab to select a preset camera stream configuration or configure custom video stream settings. The camera features multiple video streams with selectable settings for Profile, Resolution, Bit rate control, Compression, and Frame rate. The default names for the streams are Stream1, Stream2, Stream3, and Stream4. Although each stream can be programmed independently, the settings of one stream can limit the options available for the other stream depending on the processing power used.

NOTES

- H.264 is the new generation compression standard for digital video, also known as MPEG4 Part 10. This function offers higher video resolution than Motion JPEG or MPEG4 at the same bit rate and bandwidth, or the same quality video at a lower bit rate.
- MJPEG (Motion Joint Photographic Experts Group) is a simple compression technique for networked video. Latency is low and image quality is guaranteed, regardless of movement or complexity of the image. Image quality is controlled by adjusting the compression level, which in turn provides control over the file size, and thereby the bit rate.

Image – Basic

Use the Image-Basic tab to adjust the camera image setting values and orientation.

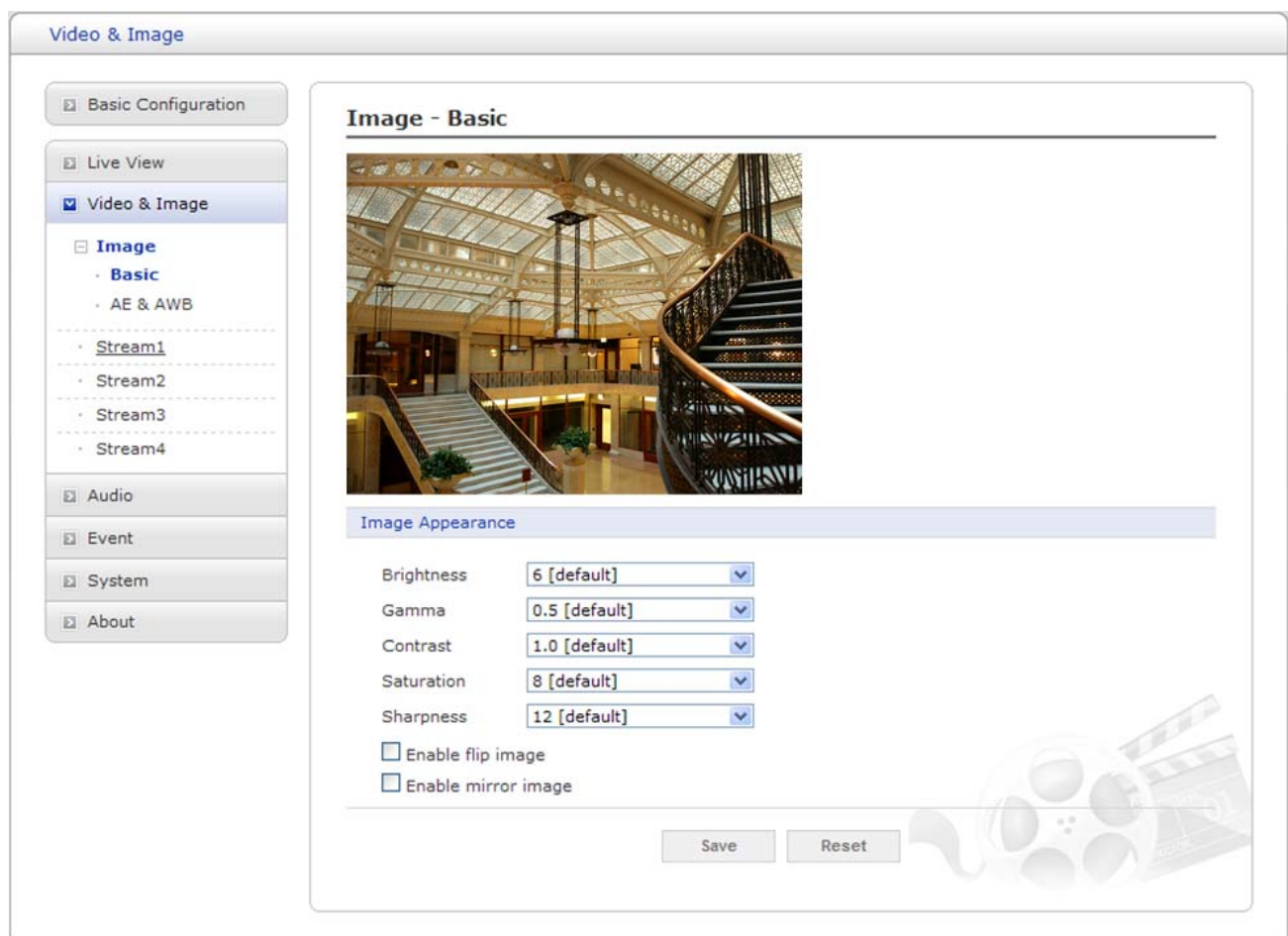

Figure 16. Video & Image / Image – Basic

Image Appearance: The image appearance allows you to adjust the camera setting parameters and change the camera orientation. All of parameters are recommended to be modifying for good image quality suitable for installation place.

Brightness: The image brightness can be adjusted in the range 0-20, where a higher value produces a brighter image. The default setting is 6.

Gamma: Adjusts the details in the light and dark areas of the scene. Gamma can be adjusted in the range 0.2-1.2, where a lower value expose more detail in the light area of the scene and a higher value expose more detail in the dark area of the scene. The default setting is 0.5.

Contrast: Controls the gradations between the darkness and lightest portions of the scene. The contrast can be adjusted in the range 1.0-2.0. The default setting is 1.0.

Saturation: Controls how intense or vivid the colors are in a scene. The saturation can be adjusted in the range 0-16. The default setting is 8.

Sharpness: Controls the clarity of detail in a scene. The sharpness can be adjusted in the range 0-20. The default setting is 12.

Enable flip image: Rotate the camera image 180 degrees vertically.

Enable mirror image: Creates a mirror image by rotating the camera image 180 degrees horizontally.

- Click the Save button to save the settings, or click the Reset button to clear all of the information you entered without saving it.

Image – AE & AWB

Use the AE & AWB tab to control the Auto Exposure and Auto White Balance.

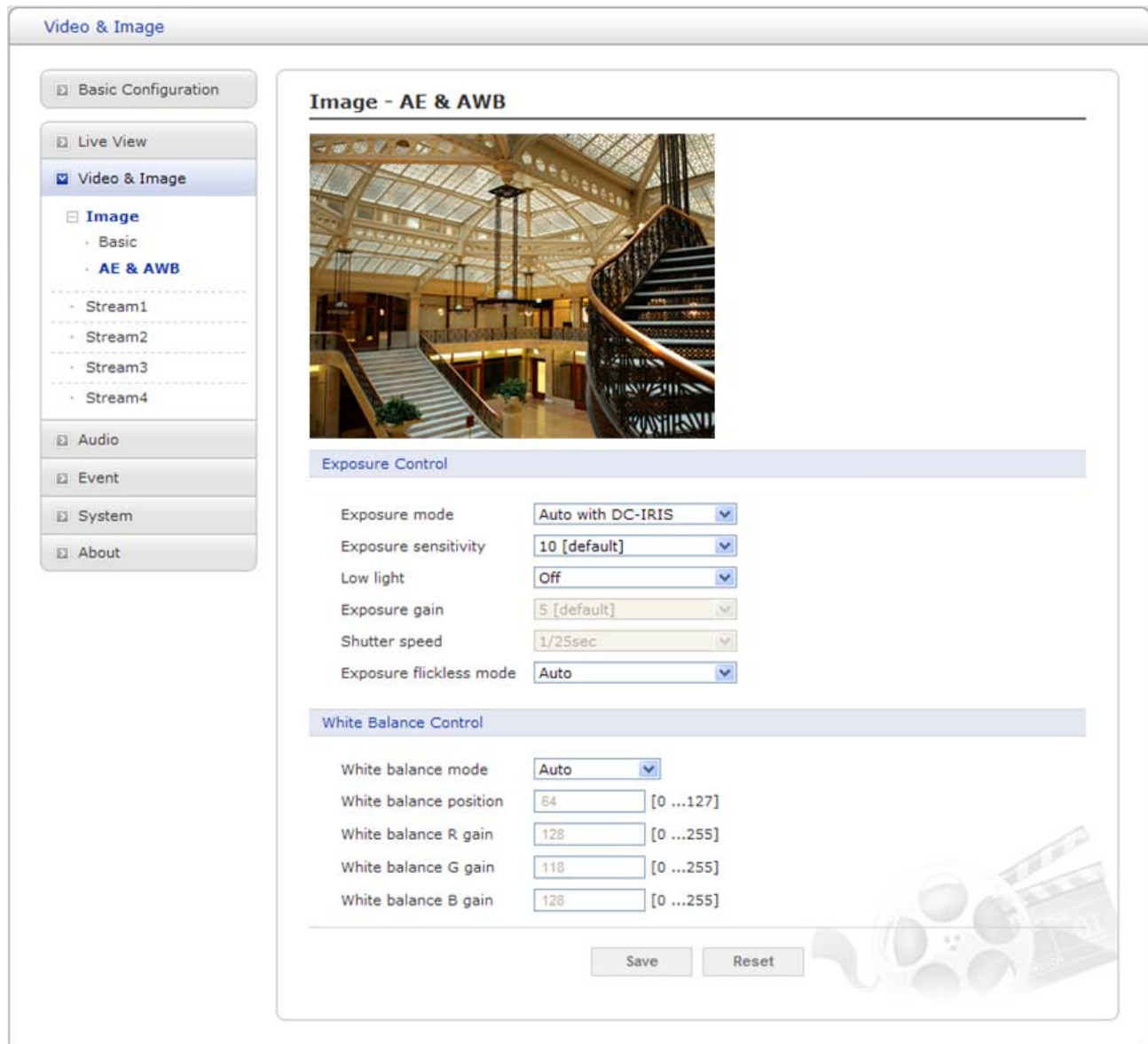

Figure 17. Video & Image / Image – AE & AWB

Exposure Control: Exposure is the amount of light detected by the camera sensor. A scene with correct exposure settings has adequate detail and contrast between white and dark values. An image with too little or too much exposure determines detail in the scene. The camera features auto and manual exposure settings.

Exposure mode: Supports exposure modes to control the amount of light detected by the camera sensor base on settings for light conditions. The default setting is Auto with DC-IRIS.

-- **Auto with DC-IRIS:** Automatically sets the amount of light detected by the DC-IRIS and AGC.

-- **Auto without DC-IRIS:** Automatically sets the amount of light detected by the AGC.

-- **Off:** Disable the function of auto exposure.

- **Manual Gain:** Increase the analog gain manually.
- **Manual Shutter:** Adjust the electronic shutter manually.
- **Manual Gain&Shutter:** Set the analog gain and electronic shutter simultaneously.

Exposure sensitivity: Indicates the sense degree for the amount of light. The exposure sensitivity can be adjusted in the range 0-14. A higher value means more sensitive. The default setting is 10.

Low Light: Provides the options for good image quality in the low light condition.

- **Off:** Keep user setting frame rate.
- **Frame control:** Increase or decrease the shutter width and the frame rate depend on current brightness.
- **Gain control:** Increase gain and image noise can be appeared.

Exposure gain: Increasing Exposure gain increases the brightness of image, but it also increases the amount of noise in the image. The exposure gain can be adjusted in the range 0-10. The default setting is 5.

Shutter speed: Select the electronic shutter speed. It's only available when Exposure mode is a Manual shutter mode. The Shutter speed can be adjusted in the range 1/1000-1/2sec. The default setting is 1/25sec.

Exposure flickless mode: Provides the options for flickless.

- **50Hz:** Select at 50 Hz environments.
- **60Hz:** Select at 60 Hz environments.

White Balance Control: White Balance Control defines how the camera processes video images to render true colors in a scene. White balance is especially effective in scenes with changing lighting conditions or in scene with more than one type of light source.

White balance mode: Provides the options for White Balance. The default setting is Auto.

- **Auto:** Automatically delivers the best possible image by adjusting the white balance based on the colors in the scene.
- **Indoor:** Select when the camera is installed at indoor.
- **Outdoor:** Select when the camera is installed at outdoor.
- **Manual gain:** Enter to the manual gain setting mode.

NOTE

In some installations, use manual white balance to render the most accurate image color possible.

White balance position: Move the white balance position into current color temperature. A higher value in the Indoor means the blue color increase and a higher value in the Outdoor means the red color increase. The White balance position can be adjusted in the range 0-127. The default setting is 64.

White balance R gain: Adjusts the picture output in the red range. The White balance R gain can be adjusted in the range 0-255, where a higher value produces a higher red image. The default setting is 127.

White balance G gain: Adjusts the picture output in the green range. The White balance G gain can be adjusted in the range 0-255, where a higher value produces a higher green image. The default setting is 117.

White balance B gain: Adjusts the picture output in the blue range. The White balance B gain can be adjusted in the range 0-255, where a higher value produces a higher blue image. The default setting is 127.

- Click the Save button to save the settings, or click the Reset button to clear all of the information you entered without saving it.

Image - Day & Night

Use the Day and Night tab for clean monitoring images even in low light conditions using IR-cut filter.

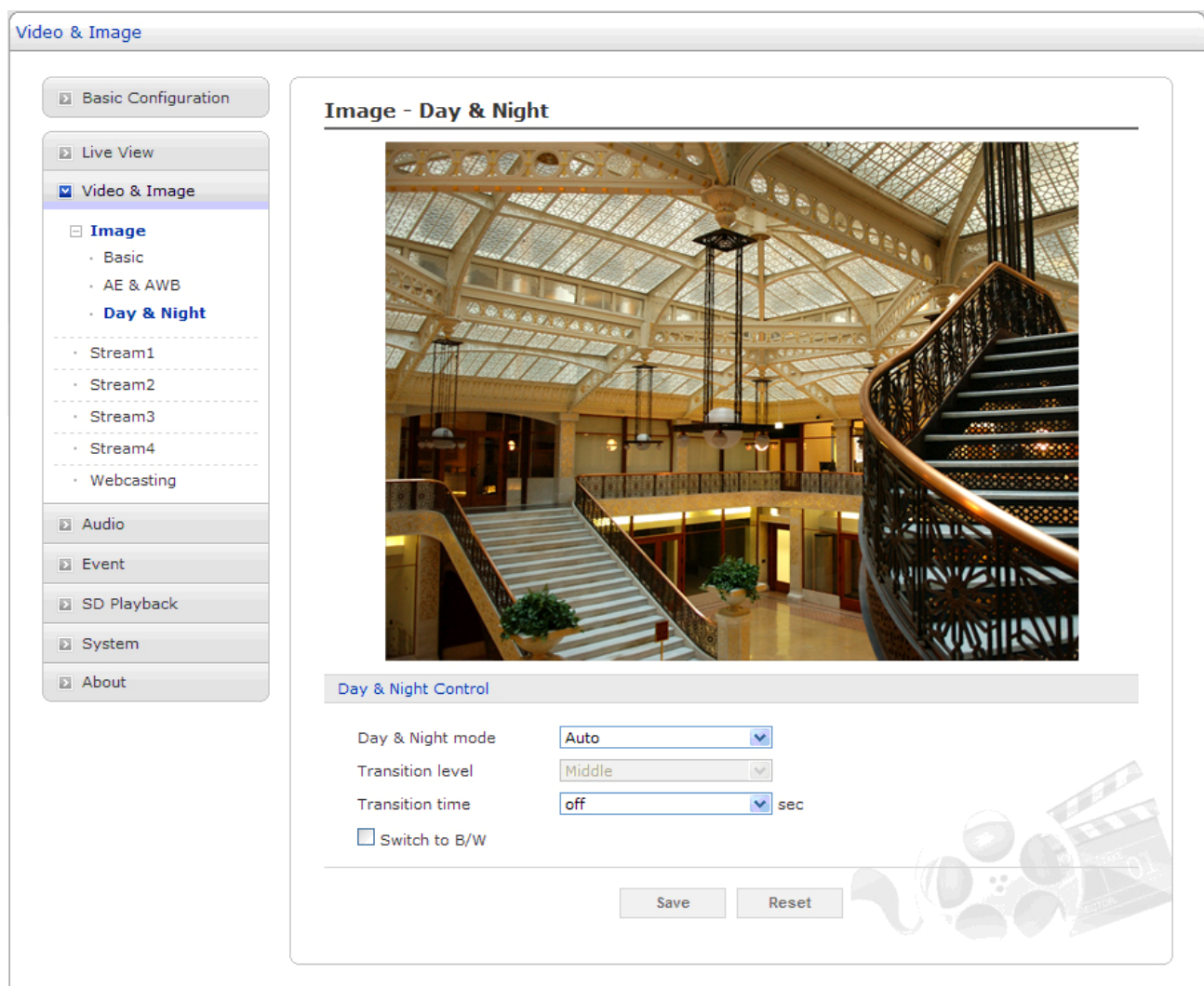

Figure 18. Video & Image / Image – Day & Night

Day & Night Control: D&N controls the position of the IR (Infra Red) cut filter, which determines the color or block-white setting of the camera. The D&N settings change depending on the exposure settings. If the camera Exposure mode is set to Auto with DC-IRIS, the D&N mode can be set to Auto, Off or Manual. If the D&N mode is set to Manual, user can be set the transition level and transition time.

Day & Night mode: Supports D&N mode to transit the IR cut filter. The default setting is Auto.

- **Auto:** Automatically controls the IR cut filter depending on the light conditions
- **Off:** Sets the IR cut filter to a fixed position.
- **Manual:** Manually sets the IR cut filter transition mode depending on the light conditions.

Transition Level: Provides various transition levels for optimizing the IR cut filter transition under such a light conditions for example halogen lamp, incandescent lamp and so forth. The default setting is Middle.

Transition Time: Provides transition detect time to transit the IR cut filter depending on the light conditions. The default setting is off

NOTE

The Transition Time controls the length of time the camera is exposed to a light level before it changes to Day and Night mode. This setting is useful for dark scenes where a bright light is momentarily introduced in the scene. For example, when a car with its headlights turned on passes the camera scene.

Switch to B/W: Click the Switch to B/W checkbox if you want to fix the camera to the Block & White mode.

- Click the Save button to save the settings, or click the Reset button to clear all of the information you entered without saving it.

Stream1

The Stream1 features the H.264 compression standard for primary stream.

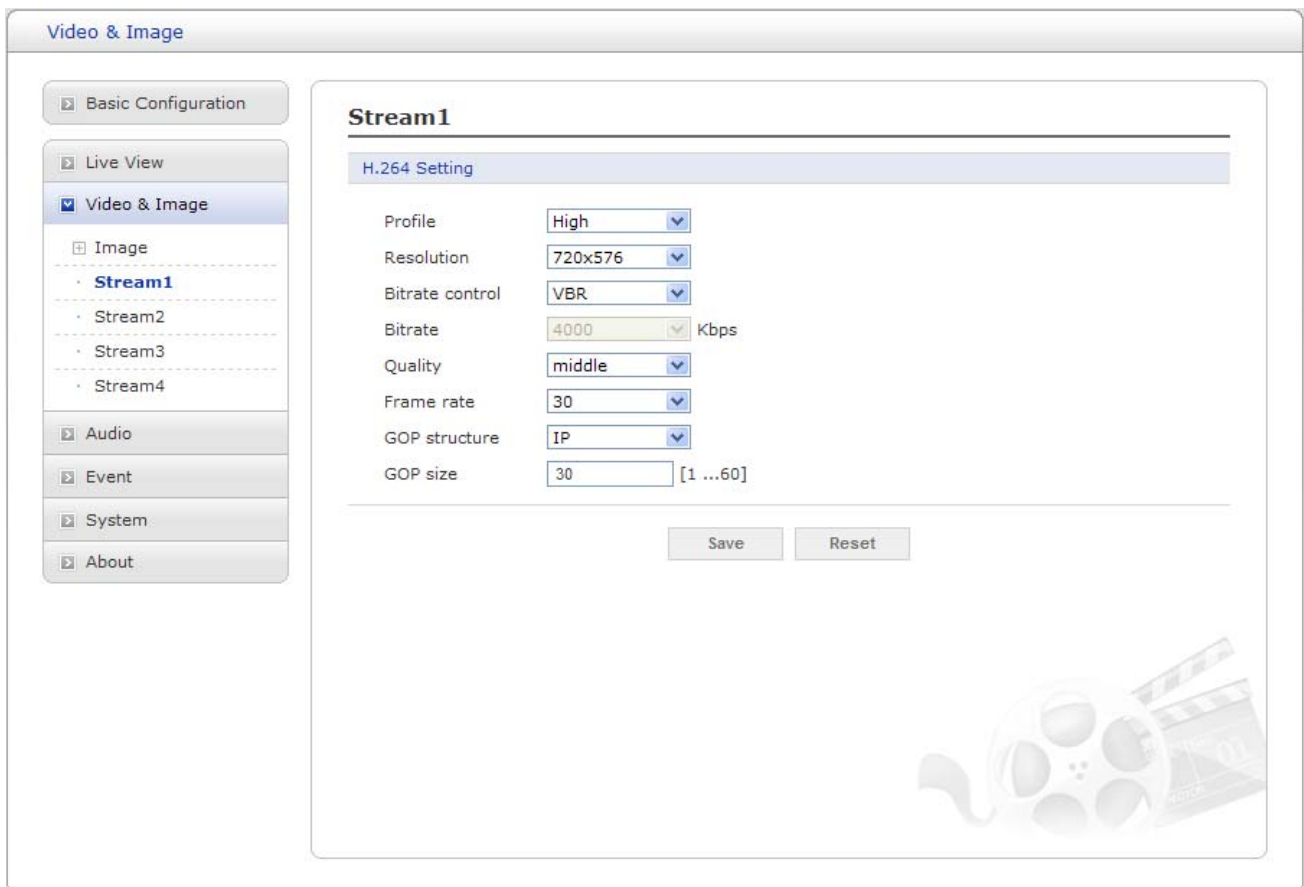

Figure 19. Video & Image / Stream1

H.264 Setting: Configures the H.264 setting value for stream1.

Profile: Selects the stream profile that is to be used for transmissions. The default setting is High.

-- **High:** The primary profile for broadcast and disc storage applications, particularly for HDTV (High-Definition television) or Blu-ray Disc applications.

-- **Main:** Originally intended as the mainstream consumer profile for broadcast and storage applications. Additional tools over baseline profile include: B slice type.

-- **Baseline:** Primarily for low-cost applications that requires additional error robustness such as video conferencing, video over-IP and mobile applications. Tools used by baseline profile include: I and P slice types.

Resolution: Specified as the number of pixel-columns (width) by the number of pixel-rows (height). The Resolution can be adjusted in the range from 320x240 to 1600x1200. The default setting is 1280x720.

NOTE

The maximum resolution setting might not be obtainable due to programmed compression standard and processor power.

Bit rate control: The bit rate can be set as VBR (Variable Bit Rate) or CBR (Constant Bit Rate).

-- **VBR:** Automatically adjusts the bit rate according to the image complexity, using up bandwidth for increased activity in the image, and less for lower activity in the monitored area.

-- **CBR:** Allows you to set a fixed target bit rate that consumes a predictable amount of bandwidth. As the bit rate would usually need to increase for increased image activity, but in this case can not, the frame rate and image quality are affected negatively.

Bit rate: Indicates the quality of the video stream (rendered in kilobits per second). The higher value means the higher video quality and bandwidth required. The Compression can be adjusted in the range from 100 to 6000 kbps. The default setting is 4000 kbps.

Quality: Automatically adjusts the compression rate to guarantee the image quality at only VBR mode. The default setting is Middle.

Frame rate: Indicates the number of fps (frame per second) available for the video stream configuration. The Frame rate can be adjusted in the range from 1 to 30 fps. The default setting is 30 fps.

NOTES

- The maximum frame rate setting might not be obtainable due to programmed compression standard, resolution of the stream, and processor power.

- A higher frame rate is advantageous when there is movement in the video stream, as it maintains image quality throughput.

GOP structure: Describes the composition of the video stream. This GOP (Group of Picture) setting configures the number of partial frames that occur between full frames in the video stream. For example, in a scene where a door opens and a person walks through, only the movements of the door and the person are stored by the video encoder. The stationary background that occurs in the previous partial frames is not encoded because no changes occurred in that part of the scene; the stationary background is only encoded in the full frames. Partial frames improve video compression rates by reducing the size of the video. As the GOP increases, the number of partial frames increases between full frames. This setting is only available with H.264 compression standards. The default setting is IP. Please consult with your network administrator before changing.

GOP size: The higher value saves considerably on bandwidth but may have an adverse effect on image quality. Higher values are only recommended on networks with high reliability. The GOP size can be adjusted in the range from 1 to 60. The default setting is 30. Please consult with your network administrator before changing.

- Click the Save button to save the settings, or click the Reset button to clear all of the information you entered without saving it.

Stream2

The Stream2 features the MJPEG compression standard for ROI.

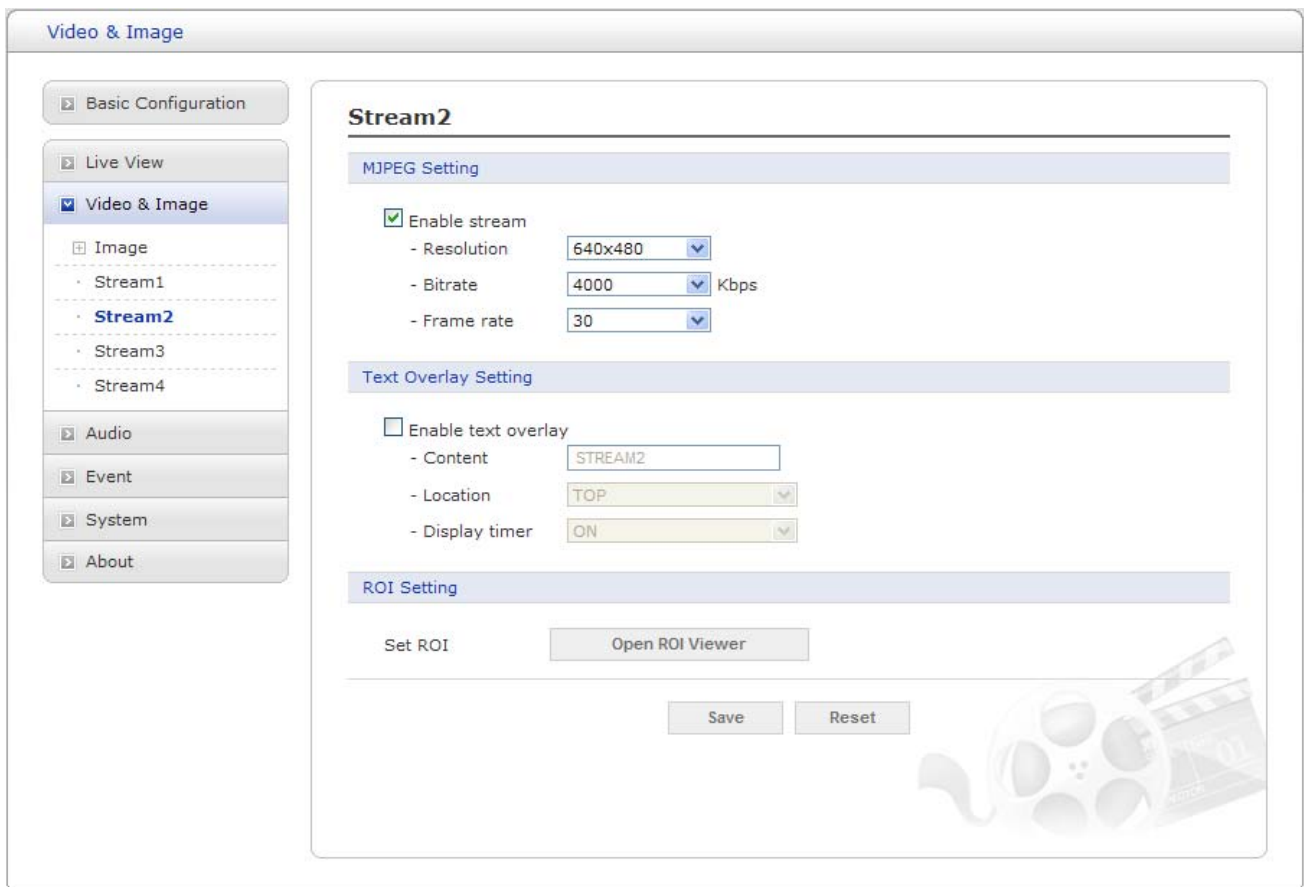

Figure 20. Video & Image / Stream2

MJPEG Setting: Configures the MJPEG setting value for stream2.

Resolution: Specified as the number of pixel-columns (width) by the number of pixel-rows (height). The Resolution can be adjusted in the range from 320x240 to 720x576. The default setting is 640x480.

NOTE

The maximum resolution setting might not be obtainable due to programmed compression standard and processor power.

Bit rate control: The bit rate can be set as VBR (Variable Bit Rate) or CBR (Constant Bit Rate).

-- **VBR:** Automatically adjusts the bit rate according to the image complexity, using up bandwidth for increased activity in the image, and less for lower activity in the monitored area.

-- **CBR:** Allows you to set a fixed target bit rate that consumes a predictable amount of bandwidth. As the bit rate would usually need to increase for increased image activity, but in this case can not, the frame rate and image quality are affected negatively.

Bit rate: Indicates the quality of the video stream (rendered in kilobits per second). The higher value means the higher video quality and bandwidth required. The Compression can be adjusted in the range from 100 to 8000 kbps. The default setting is 4000 kbps.

Frame rate: Indicates the number of fps (frame per second) available for the video stream configuration. The Frame rate can be adjusted in the range from 1 to 30 fps. The default setting is 30 fps.

NOTES

- The maximum frame rate setting might not be obtainable due to programmed compression standard, resolution of the stream, and processor power.
- A higher frame rate is advantageous when there is movement in the video stream, as it maintains image quality throughput.

Text Overlay Setting: Allows you to overlay user favorite text into image. Click the Enable text overlay box to enable text overlay.

Content: Click in the Content box and type a description for the text you are creating (from 1 to 20 alphanumeric characters).

Location: Select the appropriate place to locate the Content description.

Display timer: Provides the device timer setting value. The default setting is OFF.

ROI Setting: ROI (Region of Interest) features that transmit the specially selected area in the primary stream using different channel, resolution, and frame rate.

Open ROI viewer: Click the Open ROI viewer box and then appears the new popup window to assign the ROI stream.

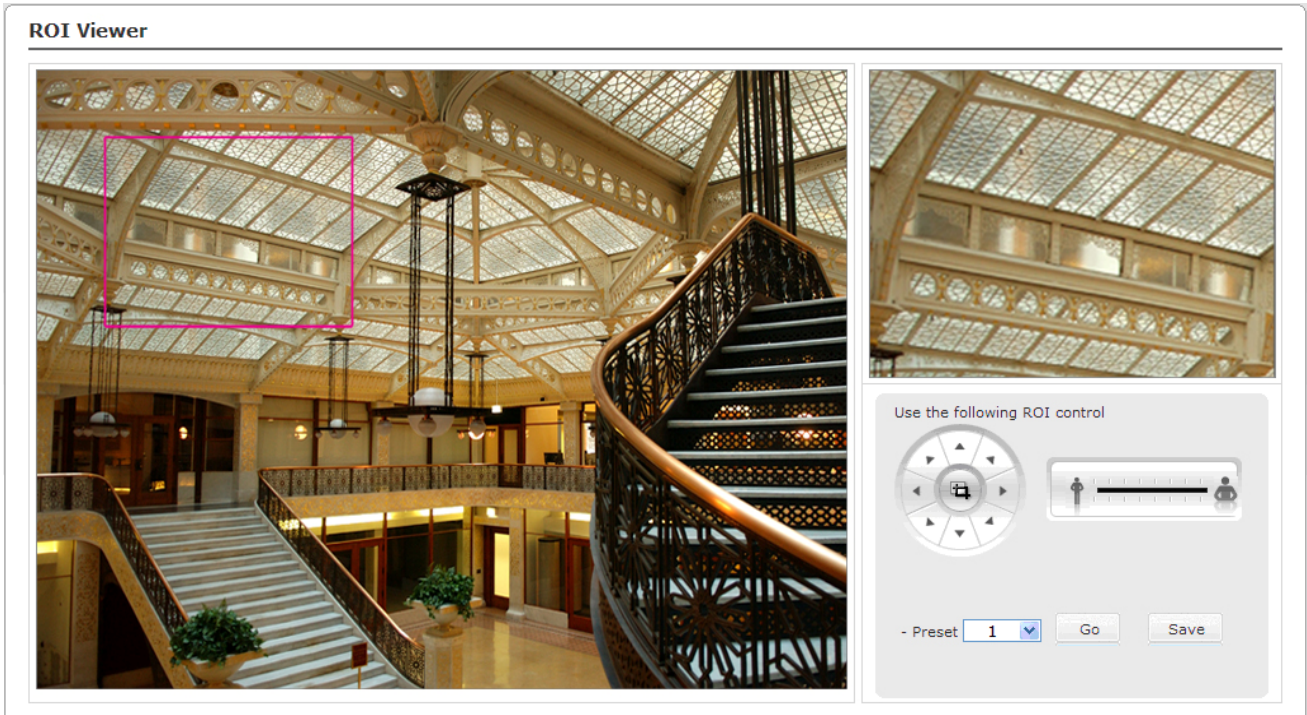

Figure 21. Video & Image / Stream2 ROI setting

Configure ROI as follows :

1. Move the square box to specific region or adjust the size of square box if you want.
2. User can configure ROI setting using arrow key to move the position of square box or using scroll bar to adjust the size of square box.
3. User can save the ROI as a preset and access to preset position in easy way. First, selects the preset position and then just click "Go" button.

NOTE

The ROI setting values in this page are applied as soon as clicking / moving.

- Click the Save button to save the settings, or click the Reset button to clear all of the information you entered without saving it.

Stream3

The Stream3 features the H.264 compression standard for ROI.

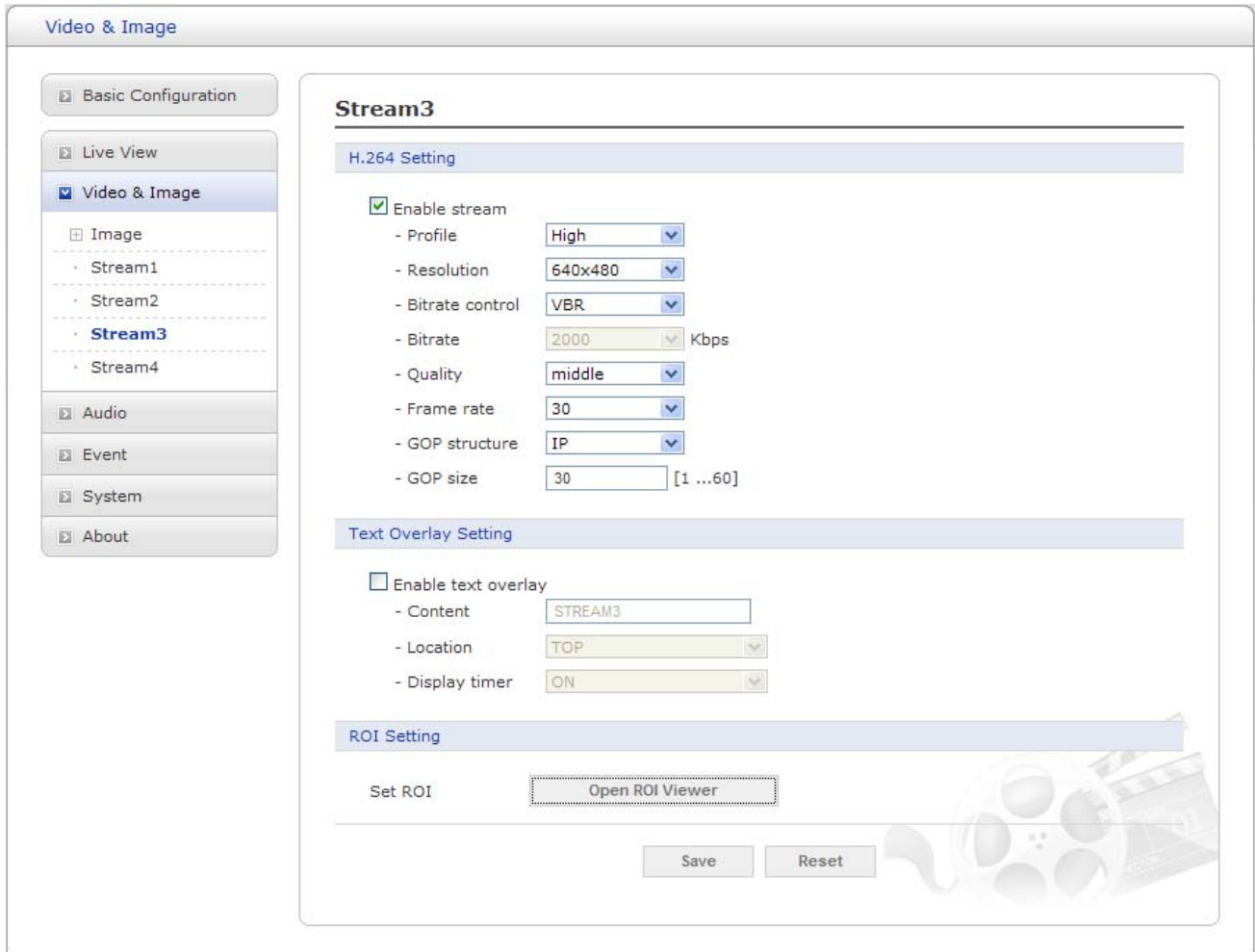

Figure 22. Video & Image / Stream3

H.264 Setting: Configures the H.264 setting value for stream3.

Profile: Choose a profile. The default setting is High.

-- **High:** The primary profile for broadcast and disc storage applications, particularly for HDTV (High-Definition television) or Blu-ray Disc applications.

-- **Main:** Originally intended as the mainstream consumer profile for broadcast and storage applications. Additional tools over baseline profile include: B slice type.

-- **Baseline:** Primarily for low-cost applications that requires additional error robustness such as video conferencing, video over-IP and mobile applications. Tools used by baseline profile include: I and P slice types.

Resolution: Specified as the number of pixel-columns (width) by the number of pixel-rows (height). The Resolution can be adjusted in the range from 320x240 to 720x576. The default setting is 640x480.

NOTE

The maximum resolution setting might not be obtainable due to programmed compression standard and processor power.

Bit rate control: The bit rate can be set as VBR (Variable Bit Rate) or CBR (Constant Bit Rate).

-- **VBR:** Automatically adjusts the bit rate according to the image complexity, using up bandwidth for increased activity in the image, and less for lower activity in the monitored area.

-- **CBR:** Allows you to set a fixed target bit rate that consumes a predictable amount of bandwidth. As the bit rate would usually need to increase for increased image activity, but in this case can not, the frame rate and image quality are affected negatively.

Bit rate: Indicates the quality of the video stream (rendered in kilobits per second). The higher value means the higher video quality and bandwidth required. The Compression can be adjusted in the range from 100 to 8000 kbps. The default setting is 2000 kbps.

Quality: Automatically adjusts the compression rate to guarantee the image quality at only VBR mode. The default setting is Middle.

Frame rate: Indicates the number of fps (frame per second) available for the video stream configuration. The Frame rate can be adjusted in the range from 1 to 30 fps. The default setting is 30 fps.

NOTES

- The maximum frame rate setting might not be obtainable due to programmed compression standard, resolution of the stream, and processor power.

- A higher frame rate is advantageous when there is movement in the video stream, as it maintains image quality throughput.

GOP structure: Describes the composition of the video stream. This GOP (Group of Picture) setting configures the number of partial frames that occur between full frames in the video stream. For example, in a scene where a door opens and a person walks through, only the movements of the door and the person are stored by the video encoder. The stationary background that occurs in the previous partial frames is not encoded because no changes occurred in that part of the scene; the stationary background is only encoded in the full frames. Partial frames improve video compression rates by reducing the size of the video. As the GOP increases, the number of partial frames increases between full frames. This setting is only available with H.264 compression standards. The default setting is IP. Please consult with your network administrator before changing.

GOP size: The higher value saves considerably on bandwidth but may have an adverse effect on image quality. Higher values are only recommended on networks with high reliability. The GOP size can be adjusted in the range from 1 to 60. The default setting is 30. Please consult with your network administrator before changing.

Text Overlay Setting: Allows you to overlay user favorite text into image. Click the Enable text overlay box to enable text overlay.

Content: Click in the Content box and type a description for the text you are creating (from 1 to 20 alphanumeric characters).

Location: Select the appropriate place to locate the Content description.

Display timer: Provides the device timer setting value. The default setting is OFF.

ROI Setting: ROI (Region of Interest) features that transmit specially selected area in the primary stream using different channel, resolution, and frame rate.

Open ROI viewer: Click the Open ROI viewer box and then appears the new popup window to assign the ROI stream.

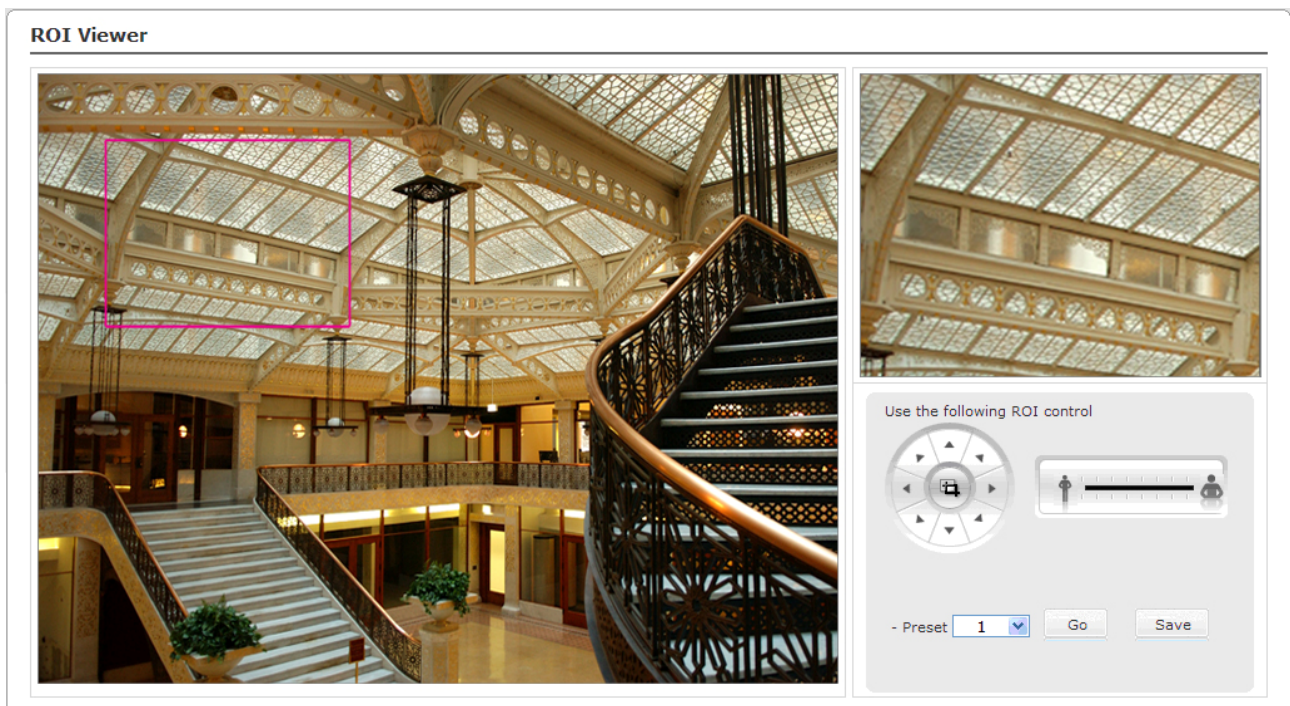

Figure 23. Video & Image / Stream3 ROI setting

Configure ROI as follows :

1. Move the square box to specific region or adjust the size of square box if you want.
2. User can configure ROI setting using arrow key to move the position of square box or using scroll bar to adjust the size of square box.
3. User can save the ROI as a preset and access to preset position in easy way. First, selects the preset position and then just click "Go" button.

NOTE

The ROI setting values in this page are applied as soon as clicking / moving.

- Click the Save button to save the settings, or click the Reset button to clear all of the information you entered without saving it.

Stream4

The Stream4 features the H.264 compression standard for ROI.

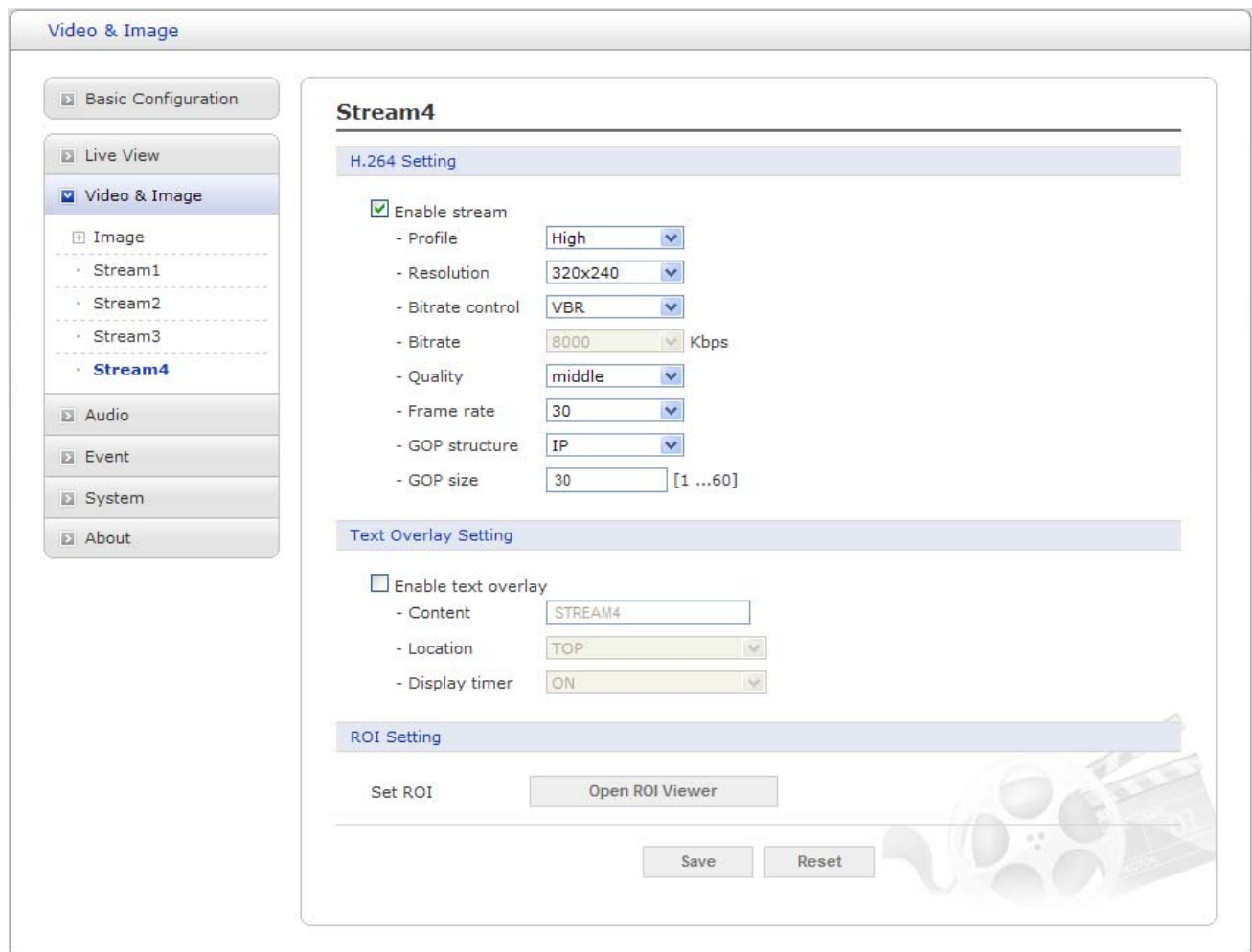

Figure 24. Video & Image / Stream4

H.264 Setting: Configures the H.264 setting value for stream4.

Profile: Choose a profile. The default setting is High.

-- **High:** The primary profile for broadcast and disc storage applications, particularly for HDTV (High-Definition television) or Blu-ray Disc applications.

-- **Main:** Originally intended as the mainstream consumer profile for broadcast and storage applications. Additional tools over baseline profile include: B slice type.

-- **Baseline:** Primarily for low-cost applications that requires additional error robustness such as video conferencing, video over-IP and mobile applications. Tools used by baseline profile include: I and P slice types.

Resolution: Specified as the number of pixel-columns (width) by the number of pixel-rows (height). The Resolution can be adjusted in the range from 320x240 to 640x480. The default setting is 640x480.

NOTE

The maximum resolution setting might not be obtainable due to programmed compression standard and processor power.

Bit rate control: The bit rate can be set as VBR (Variable Bit Rate) or CBR (Constant Bit Rate).

-- **VBR:** Automatically adjusts the bit rate according to the image complexity, using up bandwidth for increased activity in the image, and less for lower activity in the monitored area.

-- **CBR:** Allows you to set a fixed target bit rate that consumes a predictable amount of bandwidth. As the bit rate would usually need to increase for increased image activity, but in this case can not, the frame rate and image quality are affected negatively.

Bit rate: Indicates the quality of the video stream (rendered in kilobits per second). The higher value means the higher video quality and bandwidth required. The Compression can be adjusted in the range from 100 to 8000 kbps. The default setting is 500 kbps.

Quality: Automatically adjusts the compression rate to guarantee the image quality at only VBR mode. The default setting is Middle.

Frame rate: Indicates the number of fps (frame per second) available for the video stream configuration. The Frame rate can be adjusted in the range from 1 to 30 fps. The default setting is 30 fps.

NOTES

- The maximum frame rate setting might not be obtainable due to programmed compression standard, resolution of the stream, and processor power.

- A higher frame rate is advantageous when there is movement in the video stream, as it maintains image quality throughput.

GOP structure: Describes the composition of the video stream. This GOP (Group of Picture) setting configures the number of partial frames that occur between full frames in the video stream. For example, in a scene where a door opens and a person walks through, only the movements of the door and the person are stored by the video encoder. The stationary background that occurs in the previous partial frames is not encoded because no changes occurred in that part of the scene; the stationary background is only encoded in the full frames. Partial frames improve video compression rates by reducing the size of the video. As the GOP increases, the number of partial frames increases between full frames. This setting is only available with H.264 compression standards. The default setting is IP. Please consult with your network administrator before changing.

GOP size: The higher value saves considerably on bandwidth but may have an adverse effect on image quality. Higher values are only recommended on networks with high reliability. The GOP size can be adjusted in the range from 1 to 60. The default setting is 30

Text Overlay Setting: Allows you to overlay user favorite text into image. Click the Enable text overlay box to enable text overlay.

Content: Click in the Content box and type a description for the text you are creating (1 to 20 alphanumeric characters).

Location: Select the appropriate place to locate the Content description.

Display timer: Provides the device timer setting value. The default setting is OFF.

ROI Setting: ROI (Region of Interest) features that transmit specially selected area in the primary stream using different channel, resolution, and frame rate.

Open ROI viewer: Click the Open ROI viewer box and then appears the new popup window to assign the ROI stream.

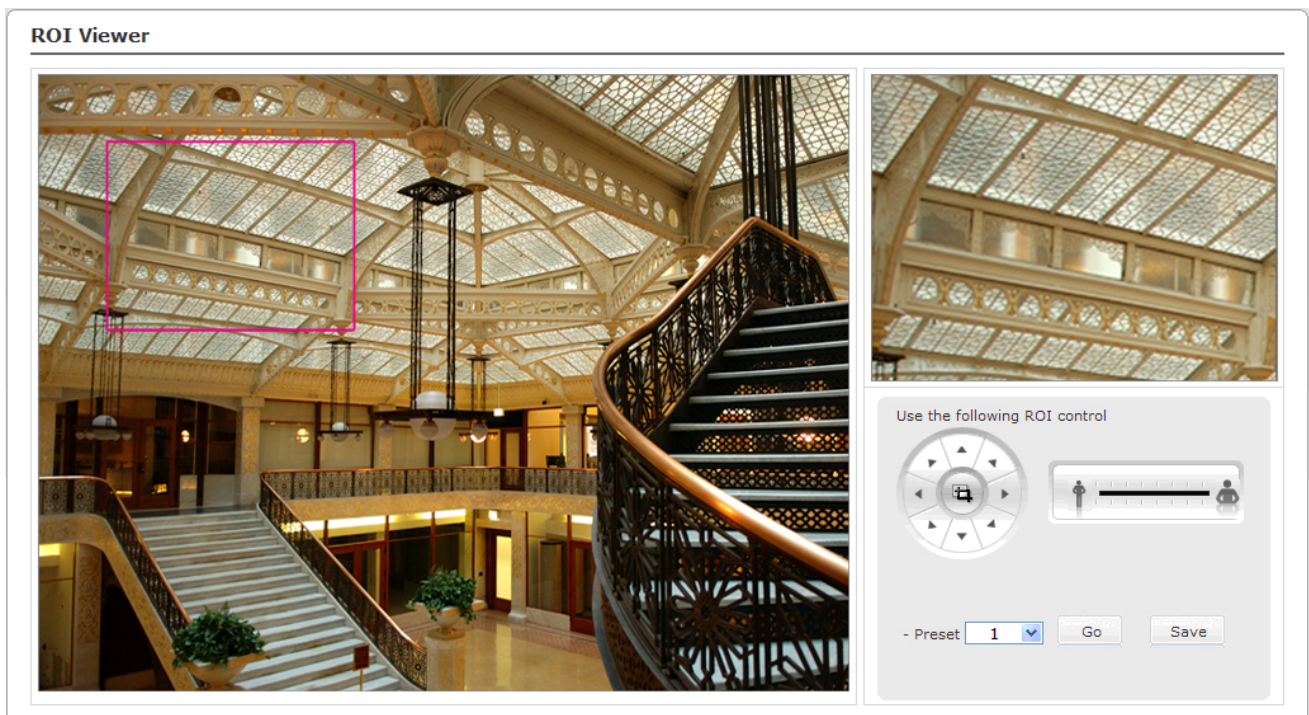

Figure 25. Video & Image / Stream4 ROI setting

Configure ROI as follows:

1. Move the square box to specific region or adjust the size of square box if you want.
2. User can configure ROI setting using arrow key to move the position of square box or using scroll bar to adjust the size of square box.
3. User can save the ROI as a preset and access to preset position in easy way. First, selects the preset position and then just click "Go" button.

NOTE

The ROI setting values in this page are applied as soon as clicking / moving.

- Click the Save button to save the settings, or click the Reset button to clear all of the information you entered without saving it.

Webcasting

The NXD Series can stream live video to a website. Copy the HTML code generated on the screen and paste it in page code of the website you want to display live video.

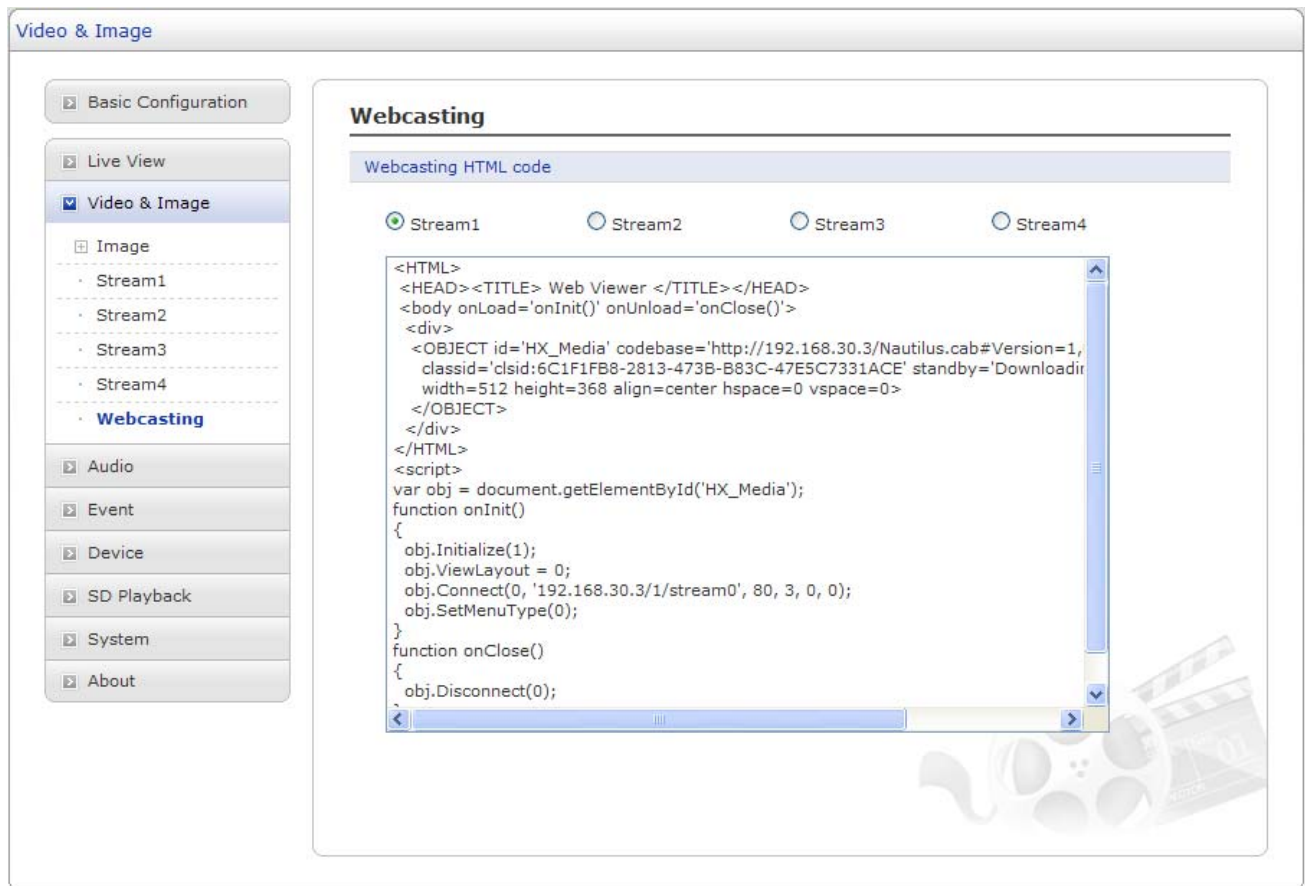

Figure 26. Video & Image / Webcasting

Webcasting HTML code: Supports 4 streams for webcasting service. First, selects one from the Stream1 to Stream4 and then copy the HTML code and paste them to your website page code.

NOTE

To use webcasting service, the Enable Anonymous viewer login option must be enabled.

Audio

This camera supports the audio full duplex that can be transmits and receives audio in both directions at a time.

Basic

Use the Audio tab to manage and configure the basic audio settings for the camera.

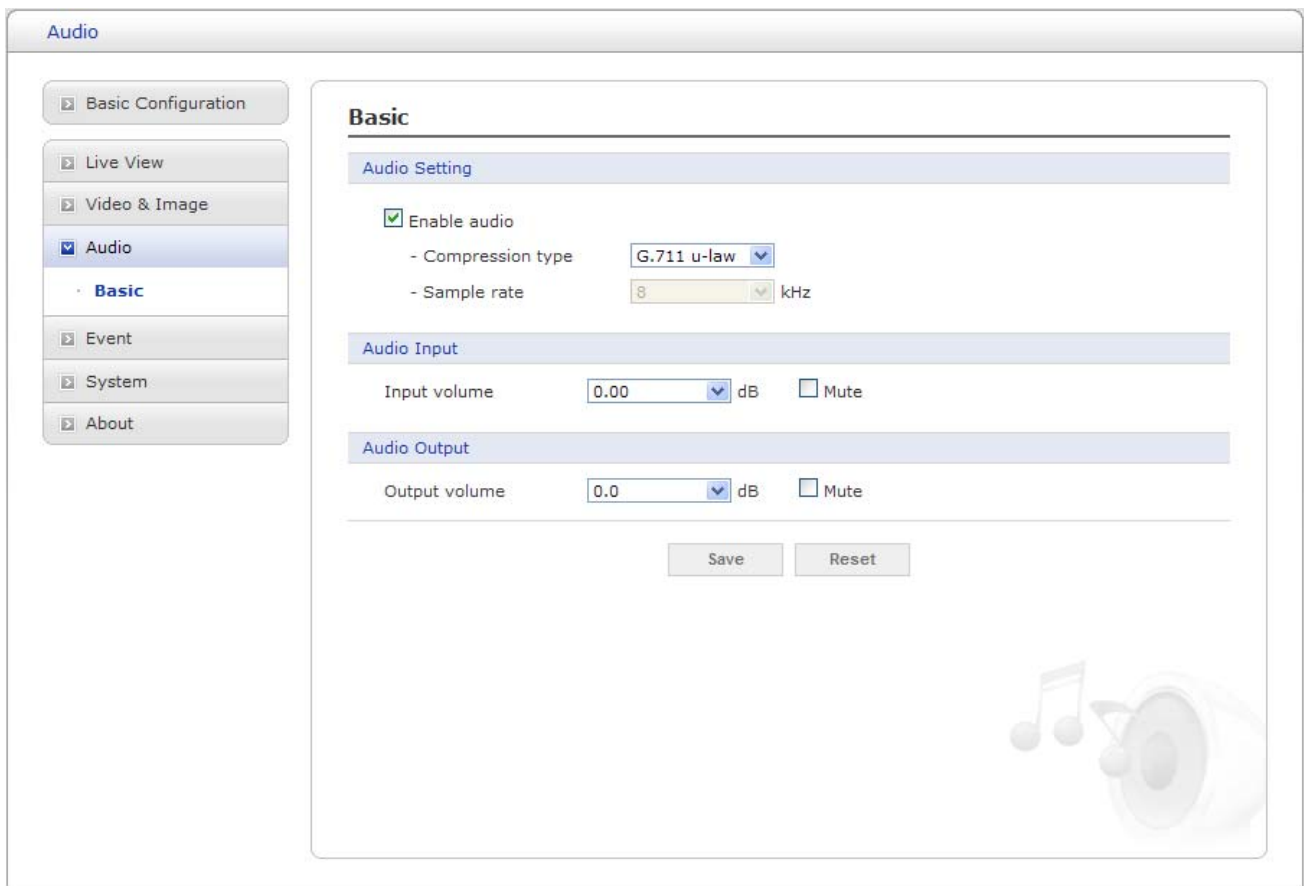

Figure 27. Audio / Basic

Audio Setting: Click the Enable audio checkbox to enable audio. This page describes how to configure the basic audio settings for the camera.

Compression type: G.711 is the international standard for encoding wired-telephone audio on 64kBit/s channel. It is a PCM (Pulse Code Modulation) scheme operating at 8 kHz sample rate. The default setting is G.711 μ -law.

Sample rate: Indicates the number of times per second the sound is sampled. The default setting is 8 kHz.

NOTES

- G.711, also known as Pulse Code Modulation (PCM), is a very commonly used waveform codec. G.711 uses a sampling rate of 8,000 samples per second, with the tolerance on that rate 50 parts

per million (ppm). Non-uniform quantization (logarithmic) with 8 bits is used to represent each sample, resulting in a 64 kbit/s bit rate.

- There are two slightly different versions; μ -law, which is used primarily in North America, and A-law, which is in use in most other countries outside North America. G.711 μ -law tends to give more resolution to higher range signals while G.711 A-law provides more quantization levels at lower signal levels.

Audio Input: Adjusts the audio volume especially from the Mike.

Input volume: The Input volume can be adjusted in the range from -21.00 to 21.00 dB. The default setting is 0 dB. Click the Mute box if you do not want the audio input.

Audio Output: Adjusts the audio volume especially to the Speaker.

Output volume: The Output volume can be adjusted in the range from -18.1 to 6.0 dB. The default setting is 0 dB. Click the Mute box if you do not want the audio output.

- Click the Save button to save the settings, or click the Reset button to clear all of the information you entered without saving it.

Event

The Event tabs describe how and when the unit will perform certain actions. Alarm In, Manual Trigger and VMD may be set up as alarm sources. Event Out is often set up to upload images, send email and activate output ports. Many event actions require an Event server for their function. This server is used to receive uploaded Motion JPEG images.

NOTE

The VMD for Stream2 (MJPEG) do not support.

Event In – Alarm In

This page allows you to configure the 2 inputs supported by the camera. Ports can be given as Normally Open or Normally Close state, and their Normal state can be configured.

An input will be inactive as long as its Normal state equals its Current state. The 2 options for Normal state are NO (Normally Open) and NC (Normally Close). The input is activated when the Current state changes so that it no longer equals the Normal state.

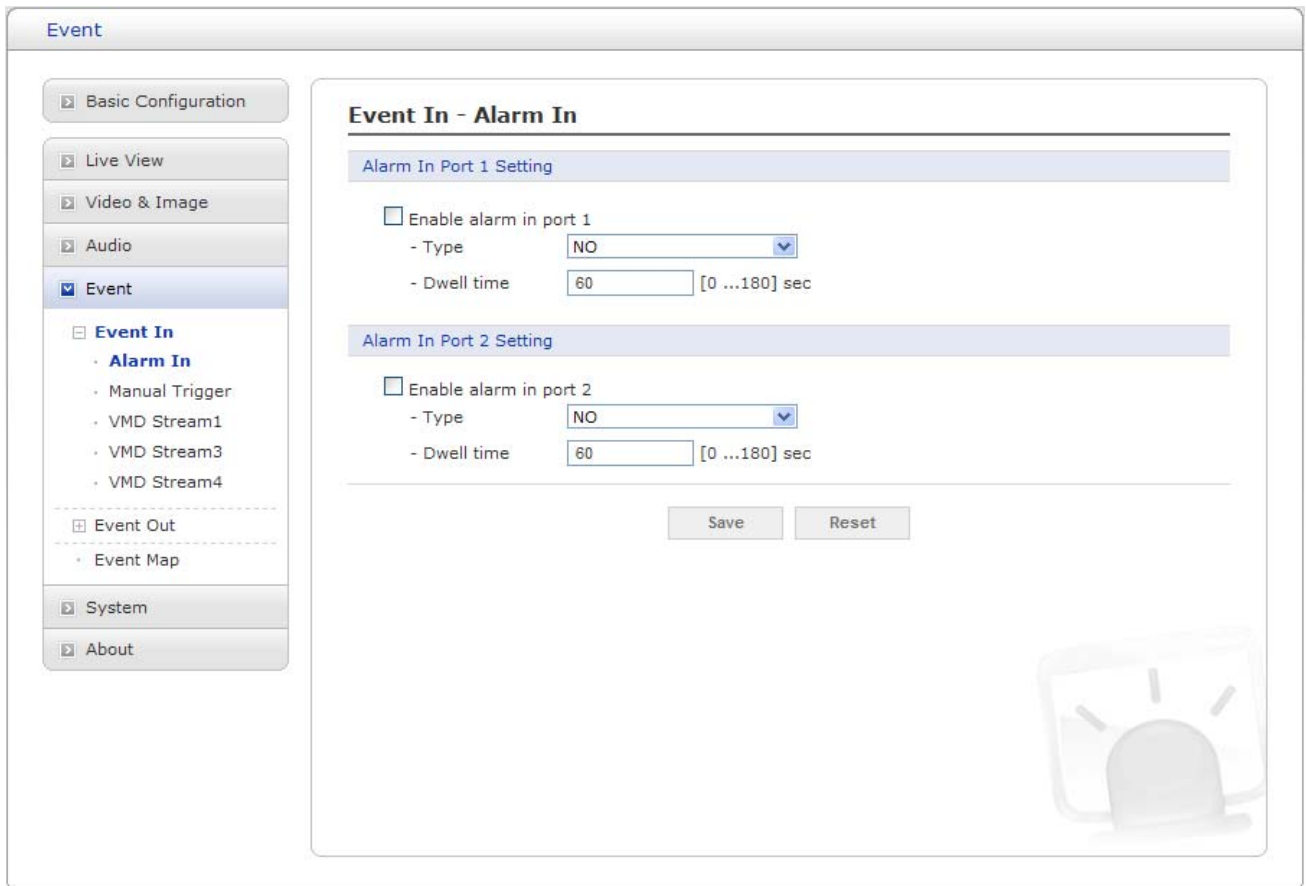

Figure 28. Event / Event In – Alarm In

Alarm In Port 1 Setting: Click the Enable alarm in port1 checkbox to enable the Alarm In port 1.

Type: The default setting is NO.

-- **NO:** Normally Open

As an example, if the Normal state for a pushbutton connected to an input is Open circuit, this means that as long as the button is not pushed (and the Current state remains as Open circuit), the state will be inactive.

-- **NC:** Normally Close

When the button is pushed, the circuit is grounded, the input's state changes to Grounded circuit and the input will no longer be in its normal state - it will have become active.

An input on the camera has an Open circuit when disconnected or when there is a voltage.

Dwell time: The default setting is 60 seconds.

NOTE

Dwell time means how long time the alarm input signal hold on as an input signaling source.

Alarm In Port 2 Setting: Click the Enable alarm in port2 checkbox to enable the Alarm In port 2.

Type: The default setting is NO.

-- **NO:** Normally Open

As an example, if the Normal state for a pushbutton connected to an input is Open circuit, this means that as long as the button is not pushed (and the Current state remains as Open circuit), the state will be inactive.

-- **NC:** Normally Close

When the button is pushed, the circuit is grounded, the input's state changes to Grounded circuit and the input will no longer be in its normal state - it will have become active.

An input on the camera has an Open circuit when disconnected or when there is a voltage.

Dwell time: The default setting is 60 seconds.

NOTE

If the normal state equals the current state, then the port is inactive.

Event In – Manual Trigger

The Manual Trigger features an alarm out signaling, JPEG file transfer to FTP server, and sends email to SMTP server whenever operator clicks Manual Trigger button in the Live View window.

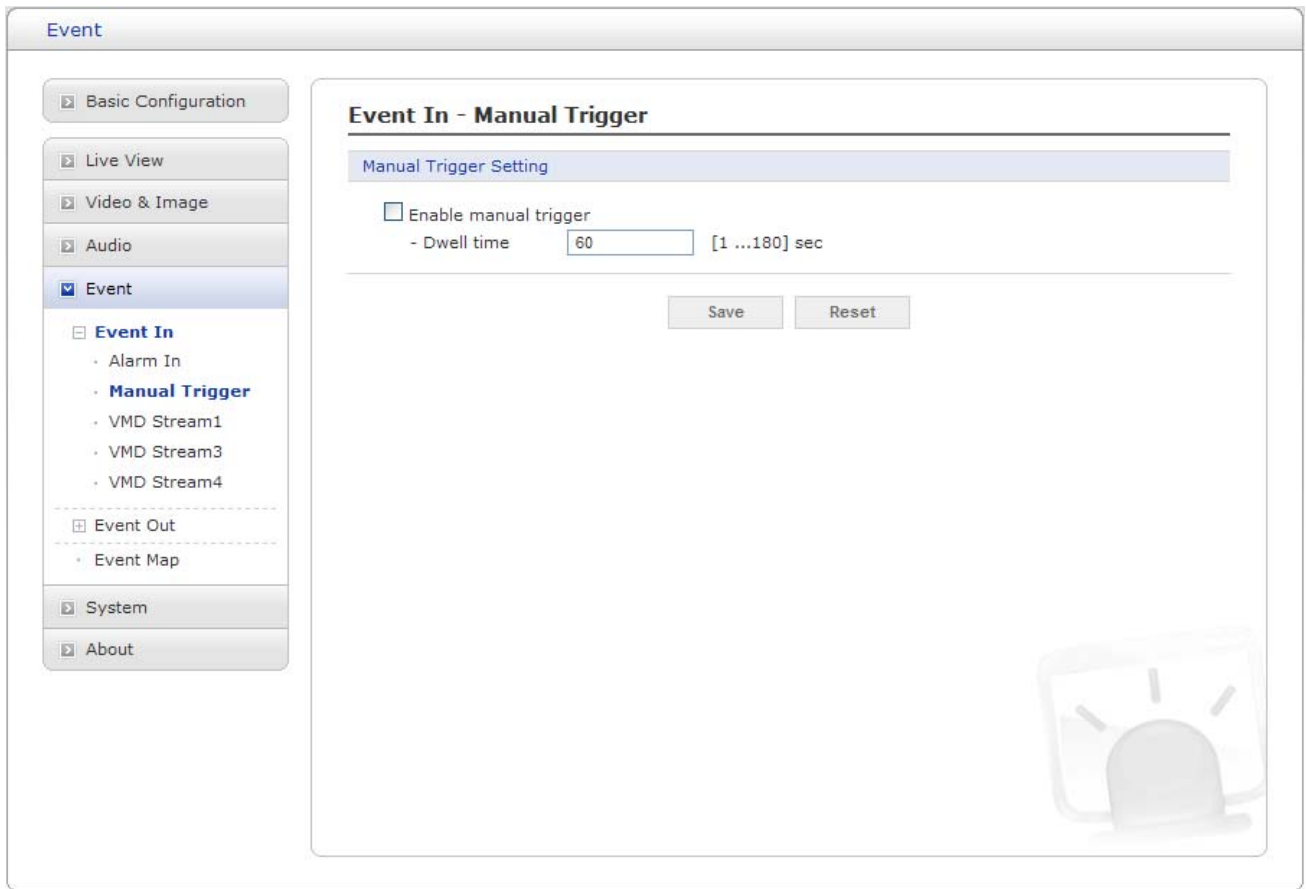

Figure 29. Event / Event In – Manual Trigger

Manual Trigger Setting: Click the Enable manual trigger checkbox to enable manual trigger.

Dwell time: The default setting is 60 seconds.

NOTE

Dwell time means how long time the alarm output signal hold on as an output signaling source.

- Click the Save button to save the settings, or click the Reset button to clear all of the information you entered without saving it.

Event In – VMD Stream1

The VMD (Video Motion Detection) feature generates an alarm whenever movement occurs in the image. Motion is detected in selected windows, which are placed in the video image to target specific areas. Movement in the areas outside the selected windows will be ignored. The camera can be configured with up to maximum 8 include windows. Windows can be moved, resized, or deleted at any time. The behavior for each window is defined by adjusting the Sensitivity, Threshold and Motion dwell time. The VMD feature is only available in the H.264 stream.

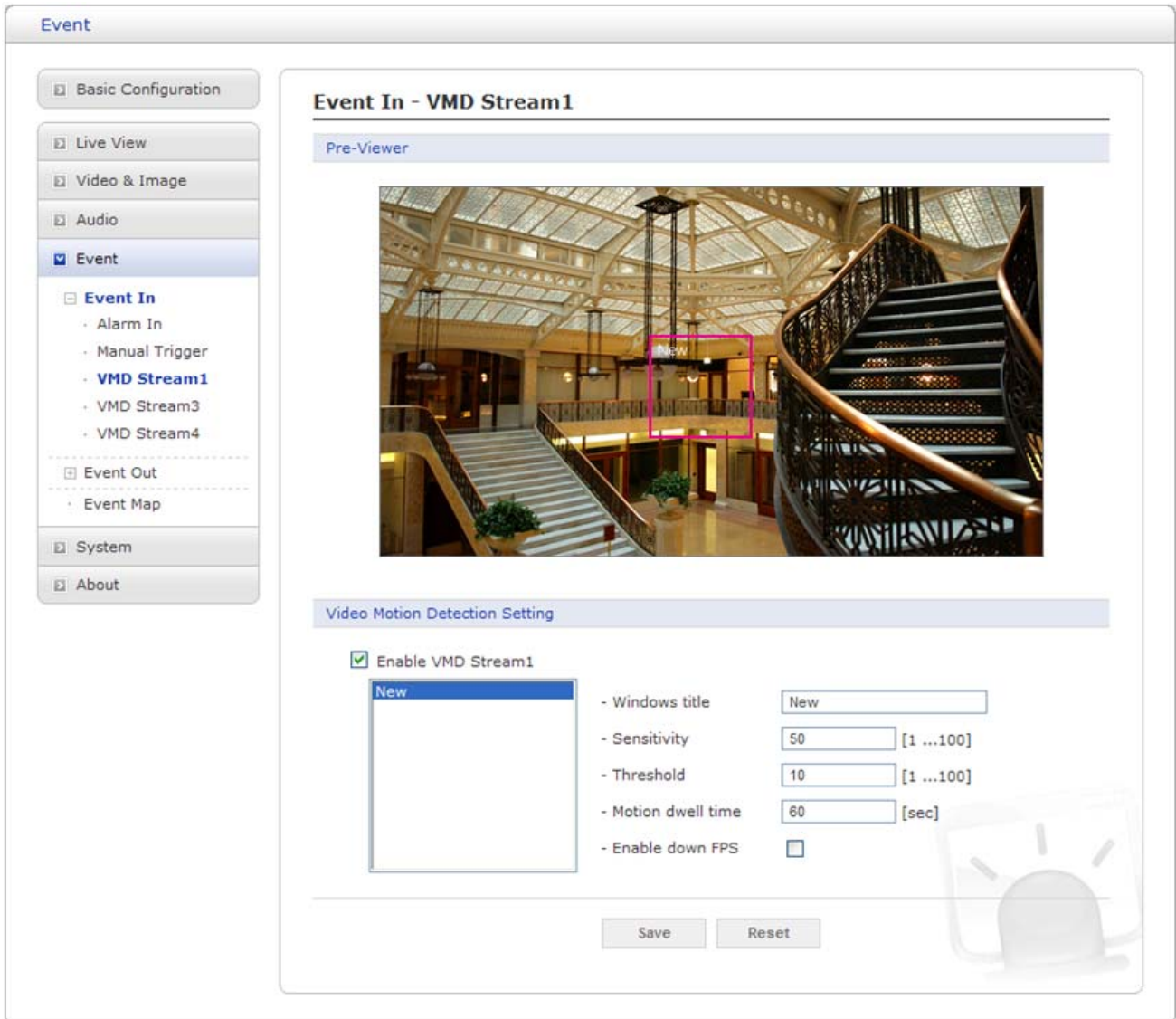

Figure 30. Event / Event In – VMD Stream1

Pre-Viewer: Provides live video image to configure VMD area.

Video Motion Detection Setting: The following step describes how to configure the camera for motion detection.

First, Click the Enable VMD stream1 checkbox to enable the VMD settings.

1. Move the mouse to Pre-Viewer window and then click the right button of the mouse. A new pop-up menu window appears.
2. Click the New tab, and then configure, resize, and place the VMD area.
3. Click in the Windows title box and type a title (1 to 31 alphanumeric characters).
4. Adjust the Sensitivity, Threshold, and Motion dwell time setting values.
5. The VMD listed shows and their setting values also show every time if you select one of the lists.
6. Click the Save button to save the settings.

NOTES

- If you want to configure more VMD area, repeat above step.
- If you want to delete VMD area, select one of the Windows title listed and then click the Remove button.

Windows title: Click in the Windows title box and type for a window's title you are creating (1 to 31 alphanumeric characters).

Sensitivity: Ordinary colored objects on ordinary backgrounds will trigger motion detection.

NOTE

To only detect flashing light, select a low sensitivity. In other cases, a high sensitivity level is recommended.

Threshold (Object Size): Only very large objects cause motion detection.

NOTE

To avoid triggering on small objects in the image, a high level can be selected. Set a low level to also trigger for small objects.

Motion dwell time: Means how long time the alarm output signal hold on as an output signaling source. The default setting is 60 seconds.

Enable down FPS: Click the Enable down FPS checkbox to enable for lower frame rate transmit in normal state. The default setting is disabling.

- Click the Save button to save the settings, or click the Reset button to clear all of the information you entered without saving it.

Event In – VMD Stream3

The VMD (Video Motion Detection) feature generates an alarm whenever movement occurs in the image. Motion is detected in selected windows, which are placed in the video image to target specific areas. Movement in the areas outside the selected windows will be ignored. The camera can be configured with up to maximum 8 include windows. Windows can be moved, resized, or deleted at any time. The behavior for each window is defined by adjusting the Sensitivity, Threshold and Motion dwell time. The VMD feature is only available in the H.264 stream.

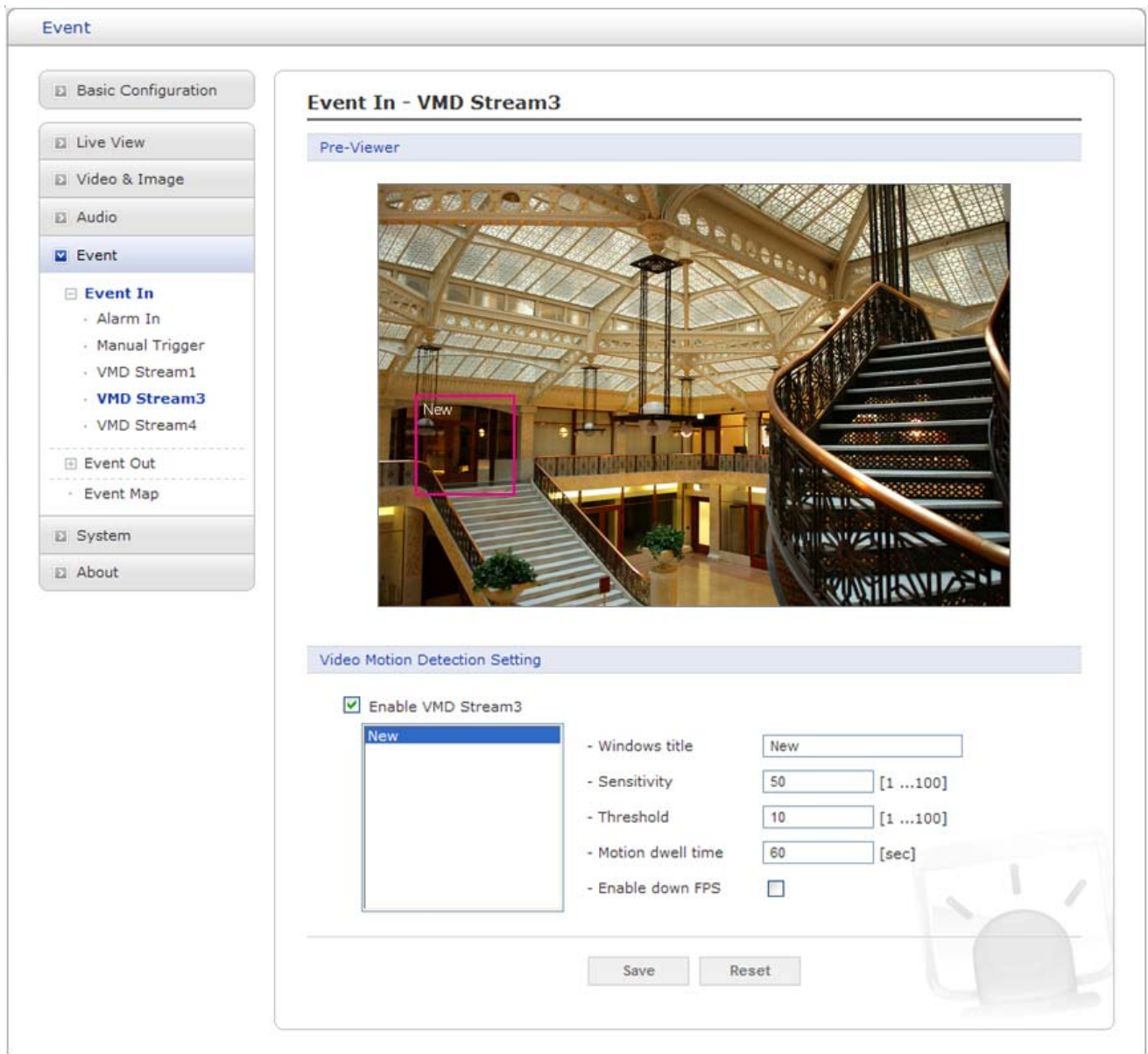

Figure 31. Event / Event In – VMD Stream3

Pre-Viewer: Provides live video image to configure VMD area.

Video Motion Detection Setting: The following step describes how to configure the camera for motion detection.

First, Click the Enable VMD stream3 checkbox to enable the VMD settings.

1. Move the mouse to Pre-Viewer window and then click the right button of the mouse. A new pop-up menu window appears.
2. Click the New tab, and then configure, resize, and place the VMD area.
3. Click in the Windows title box and type a title (1 to 31 alphanumeric characters).
4. Adjust the Sensitivity, Threshold, and Motion dwell time setting values.
5. The VMD listed shows and their setting values also show every time if you select one of the lists.
6. Click the Save button to save the settings.

NOTES

- If you want to configure more VMD area, repeat above step.
- If you want to delete VMD area, select one of the Windows title listed and then click the Remove button.

Windows title: Click in the Windows title box and type for a window's title you are creating (1 to 31 alphanumeric characters).

Sensitivity: Ordinary colored objects on ordinary backgrounds will trigger motion detection.

NOTE

To only detect flashing light, select a low sensitivity. In other cases, a high sensitivity level is recommended.

Threshold (Object Size): Only very large objects cause motion detection.

NOTE

To avoid triggering on small objects in the image, a high level can be selected. Set a low level to also trigger for small objects.

Motion dwell time: Means how long time the alarm output signal hold on as an output signaling source. The default setting is 60 seconds.

Enable down FPS: Click the Enable down FPS checkbox to enable for lower frame rate transmit in normal state. The default setting is disabling.

- Click the Save button to save the settings, or click the Reset button to clear all of the information you entered without saving it.

Event In – VMD Stream4

The VMD (Video Motion Detection) feature generates an alarm whenever movement occurs in the image. Motion is detected in selected windows, which are placed in the video image to target specific areas. Movement in the areas outside the selected windows will be ignored. The camera can be configured with up to maximum 8 include windows. Windows can be moved, resized, or deleted at any time. The behavior for each window is defined by adjusting the Sensitivity, Threshold and Motion dwell time. The VMD feature is only available in the H.264 stream.

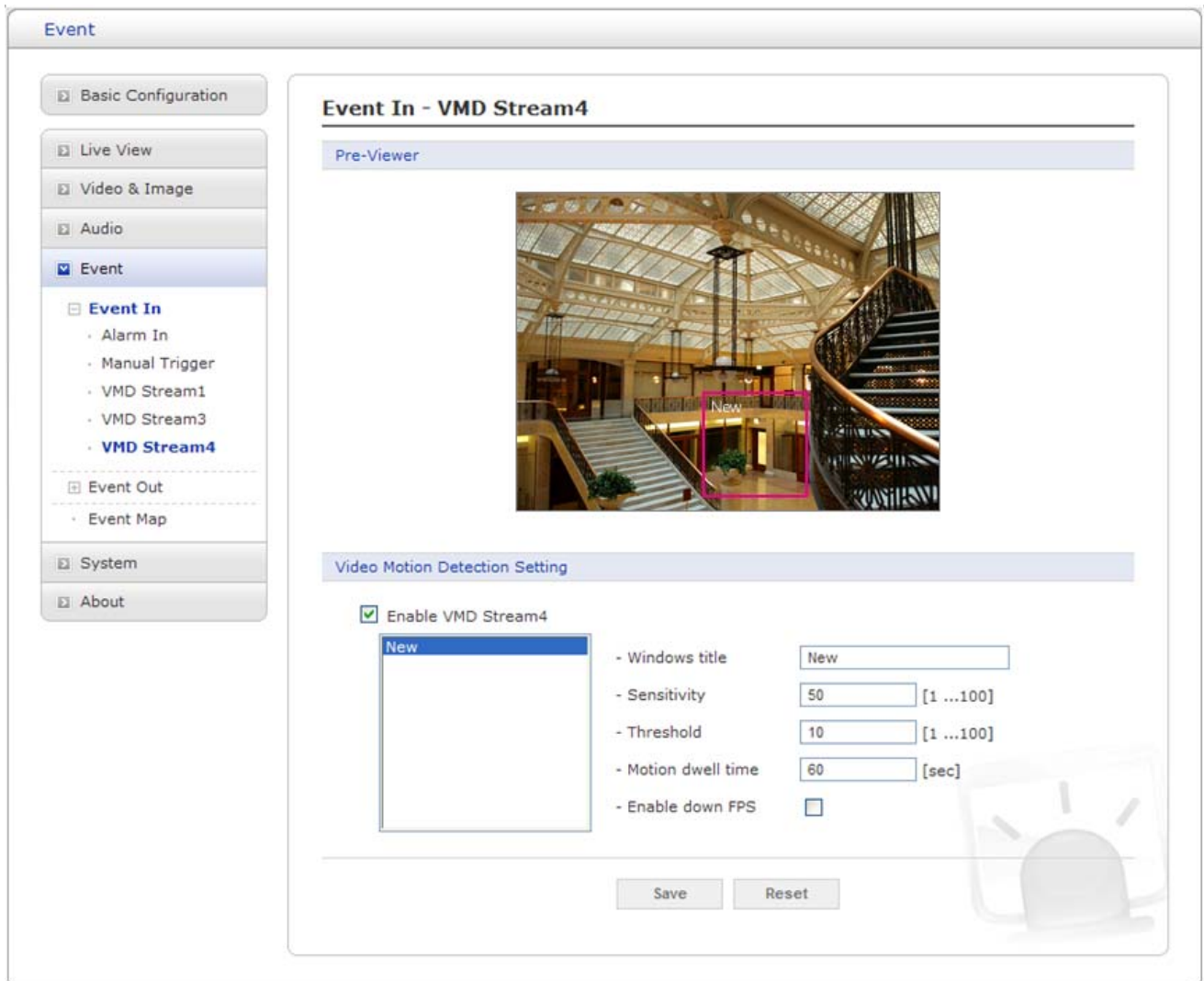

Figure 32. Event / Event In – VMD Stream4

Pre-Viewer: Provides live video image to configure VMD area.

Video Motion Detection Setting: The following step describes how to configure the camera for motion detection.

First, Click the Enable VMD stream4 checkbox to enable the VMD settings.

1. Move the mouse to Pre-Viewer window and then click the right button of the mouse. A new pop-up menu window appears.

2. Click the New tab, and then configure, resize, and place the VMD area.
3. Click in the Windows title box and type a title (1 to 31 alphanumeric characters).
4. Adjust the Sensitivity, Threshold, and Motion dwell time setting values.
5. The VMD listed shows and their setting values also show every time if you select one of the lists.
6. Click the Save button to save the settings.

NOTES

- If you want to configure more VMD area, repeat above step.
- If you want to delete VMD area, select one of the Windows title listed and then click the Remove button.

Windows title: Click in the Windows title box and type for a window's title you are creating (1 to 31 alphanumeric characters).

Sensitivity: Ordinary colored objects on ordinary backgrounds will trigger motion detection.

NOTE

To only detect flashing light, select a low sensitivity. In other cases, a high sensitivity level is recommended.

Threshold (Object Size): Only very large objects cause motion detection.

NOTE

To avoid triggering on small objects in the image, a high level can be selected. Set a low level to also trigger for small objects.

Motion dwell time: Means how long time the alarm output signal hold on as an output signaling source. The default setting is 60 seconds.

Enable down FPS: Click the Enable down FPS checkbox to enable for lower frame rate transmit in normal state. The default setting is disabling.

- Click the Save button to save the settings, or click the Reset button to clear all of the information you entered without saving it.

Event Out – SMTP (Email)

Use the Simple Mail Transfer Protocol (SMTP) server to send an email notification when an event server is activated. The camera can be configured to send event and email messages via SMTP. If your mail server requires authentication, click the Use (SMTP) authentication checkbox for use authentication to log in to this server.

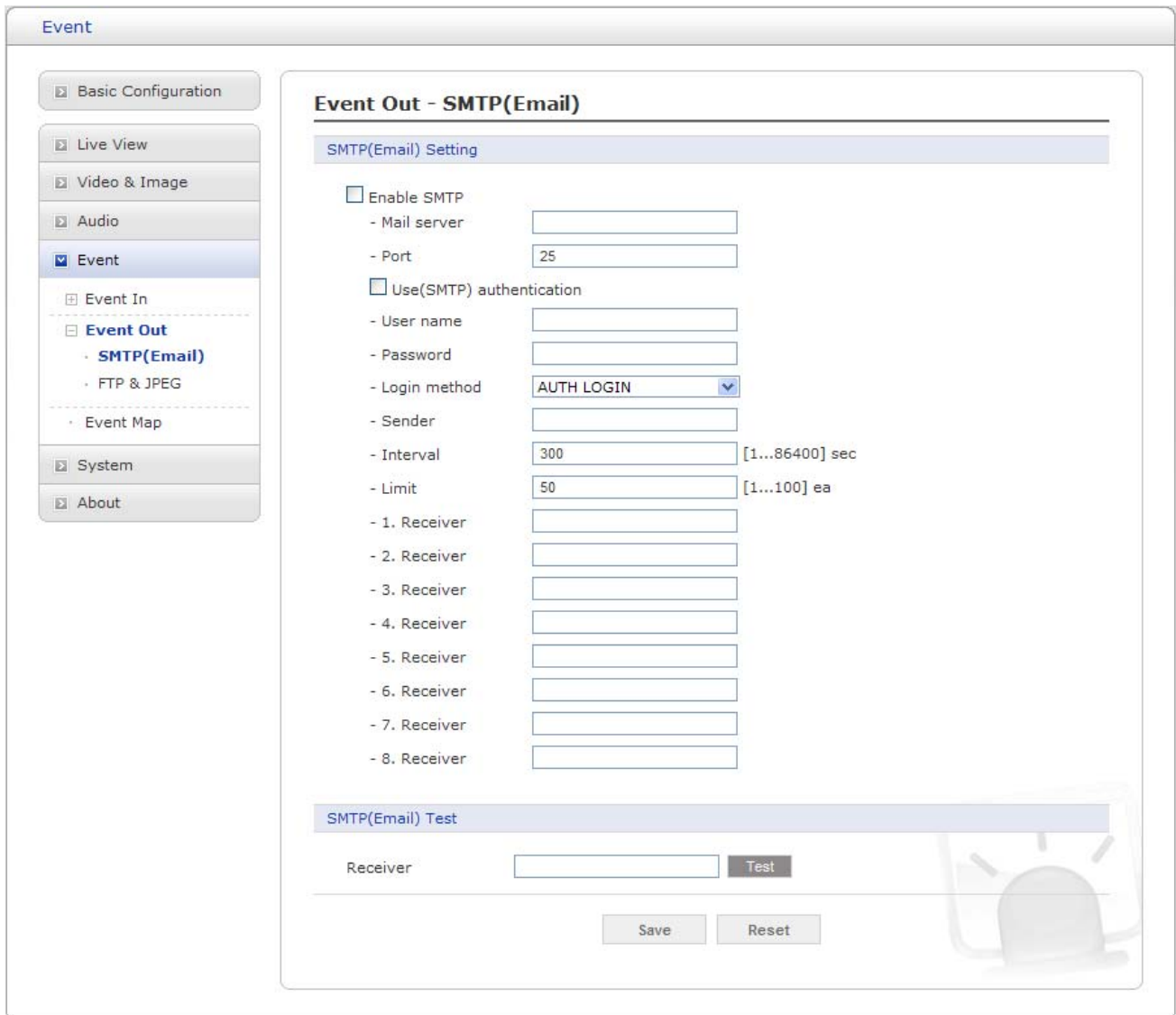

The screenshot shows a web interface for configuring Event Out - SMTP (Email). On the left is a navigation menu with options: Basic Configuration, Live View, Video & Image, Audio, Event (selected), Event In, Event Out (expanded), SMTP (Email) (selected), FTP & JPEG, Event Map, System, and About. The main content area is titled "Event Out - SMTP (Email)" and contains two sections: "SMTP (Email) Setting" and "SMTP (Email) Test".

SMTP (Email) Setting

- Enable SMTP
 - Mail server:
 - Port:
- Use (SMTP) authentication
 - User name:
 - Password:
 - Login method:
 - Sender:
 - Interval: [1...86400] sec
 - Limit: [1...100] ea
 - 1. Receiver:
 - 2. Receiver:
 - 3. Receiver:
 - 4. Receiver:
 - 5. Receiver:
 - 6. Receiver:
 - 7. Receiver:
 - 8. Receiver:

SMTP (Email) Test

Receiver:

Figure 33. Event / Event Out – SMTP (Email)

SMTP (Email) Setting: Click the Enable SMTP checkbox and provide the following information for SMTP notification:

Mail server: Enter the host names or IP addresses for your mail servers in the fields provided.

NOTES

- If these are not set, no mail can be sent.
- If a host name is used, a valid DNS server must be specified in the Network-Basic settings.

Port: Enter the SMTP server port numbers for the primary and secondary SMTP servers. The Port number can be adjusted in the range 1-65535. The default setting is 25.

NOTES

- If your mail server requires authentication, Click the Use (SMTP) authentication checkbox for use authentication to log in to this server.
- Please consult with your network administrator, if you want to change the port number.

User name: Enter the User name as provided by your network administrator.

Password: Enter the Password as provided by your network administrator.

Login method: Select one for SMTP authentication method allowed.

NOTES

- If a PLAIN or LOGIN mechanism is negotiated, the camera sends user name and password to the SMTP server.
- The LOGIN mechanism is supported by Microsoft, as well as by some other clients. Most other clients support the PLAIN authentication mechanism.
 - Since the vast majority of Email clients support *only* PLAIN or LOGIN, mail server administrators will probably want to consider using STARTTLS to provide an encryption "tunnel" between the client and server, to protect the user name and password.

Sender: Click in the Sender box and enter the email address as the sender.

Interval: Enter the time for sending an Email after occurring event.

Limit: Set the number of events for sending an Email.

Receiver: Enter the recipient's email address as the receivers.

NOTE

The Sender email address will be used as the sender for all receivers sent by this camera and the Receivers listed here will be received same email by this camera. The maximum number of Receivers is eight.

SMTP (Email) Test: Enter the recipient's email address and click the Test button to test that the mail servers are functioning and that the email address is valid. When the setup is complete, the connection can be tested by clicking the Test button.

Receiver: Enter the recipient's email address as the receiver to test.

NOTE

- Consult with your network administrator for more information on configuring email notification on your local network.
- Click the Save button to save the settings, or click the Reset button to clear all of the information you entered without saving it.

Event Out – FTP & JPEG

Save the JPEG of the activated event to a defined FTP server.

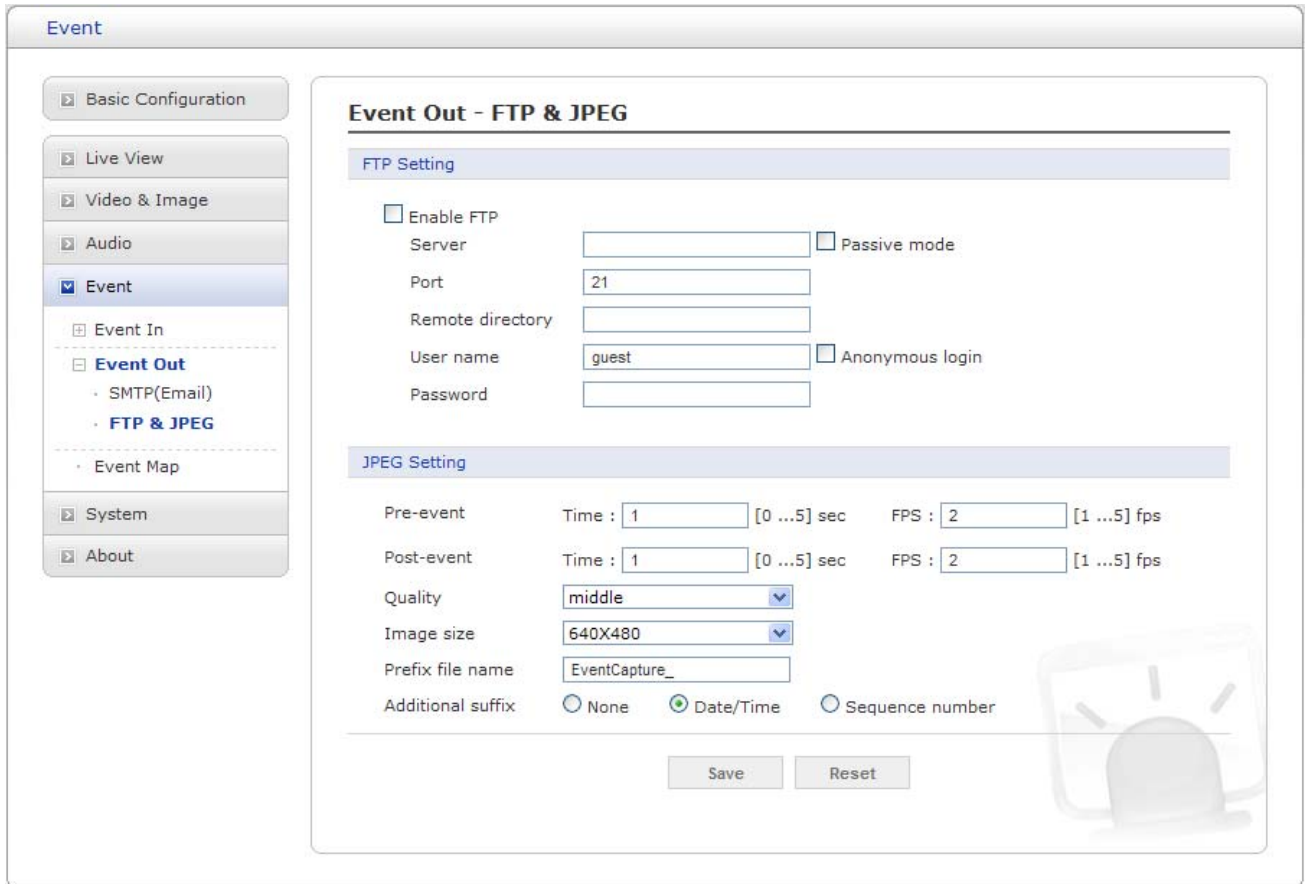

Figure 34. Event / Event Out – FTP & JPEG.

FTP Setting: FTP notification will save a file on the specified FTP server. Click the Enable FTP checkbox and provide the following information for FTP notification:

Server: Enter the IP address or host name of the target FTP server.

-- Passive Mode: Under normal circumstances the network camera simply requests the target FTP server to open the data connection. Checking this box issues a PASV command to the FTP server and establishes a passive FTP connection; whereby the network camera actively initiates both the FTP control and data connections to the target server. This is normally desirable if there is a firewall between the network camera and the target FTP server.

Port: Enter the port number used by the FTP server. The Port number can be adjusted in the range 1-65535. The default setting is 25.

Remote directory: Specify the path to the directory where the uploaded images will be stored. If this directory does not already exist on the FTP server, there will be an error message when uploading.

User name: Enter the User name as provided by your network administrator.

-- **Anonymous login:** Click the Anonymous login checkbox to permit anyone to access FTP server.

Password: Enter the Password as provided by your network administrator.

NOTE

If you permit to login FTP server by anyone without password, click the Anonymous login checkbox.

JPEG Setting: Configure the JPEG to send the FTP server.

Pre-event: Defines how many JPEG file will be made during 1-5 seconds before the event is generated.

Post-event: Defines how many JPEG file will be made during 1-5 seconds after the event is generated.

Quality: Automatically adjusts the compression rate to guarantee the image quality at only VBR mode. The default setting is Middle.

Image size: Selects the JPEG file size to send the FTP server. The default setting is 640x480.

Prefix file name: Click in the Prefix file name box and type a name for JPEG image file (1 to 35 alphanumeric characters).

Additional suffix: Provide additional information for JPEG image file.

-- **None:** Not add additional suffix.

-- **Date/Time:** Add the date and time information as JPEG image file suffix.

-- **Sequence number:** Add the sequence number as JPEG image file suffix.

- Click the Save button to save the settings, or click the Reset button to clear all of the information you entered without saving it.

Event Out – Audio Alert

When the network camera detects an event such as Alarm or Motion, it can output a predefined audio data to external speaker.

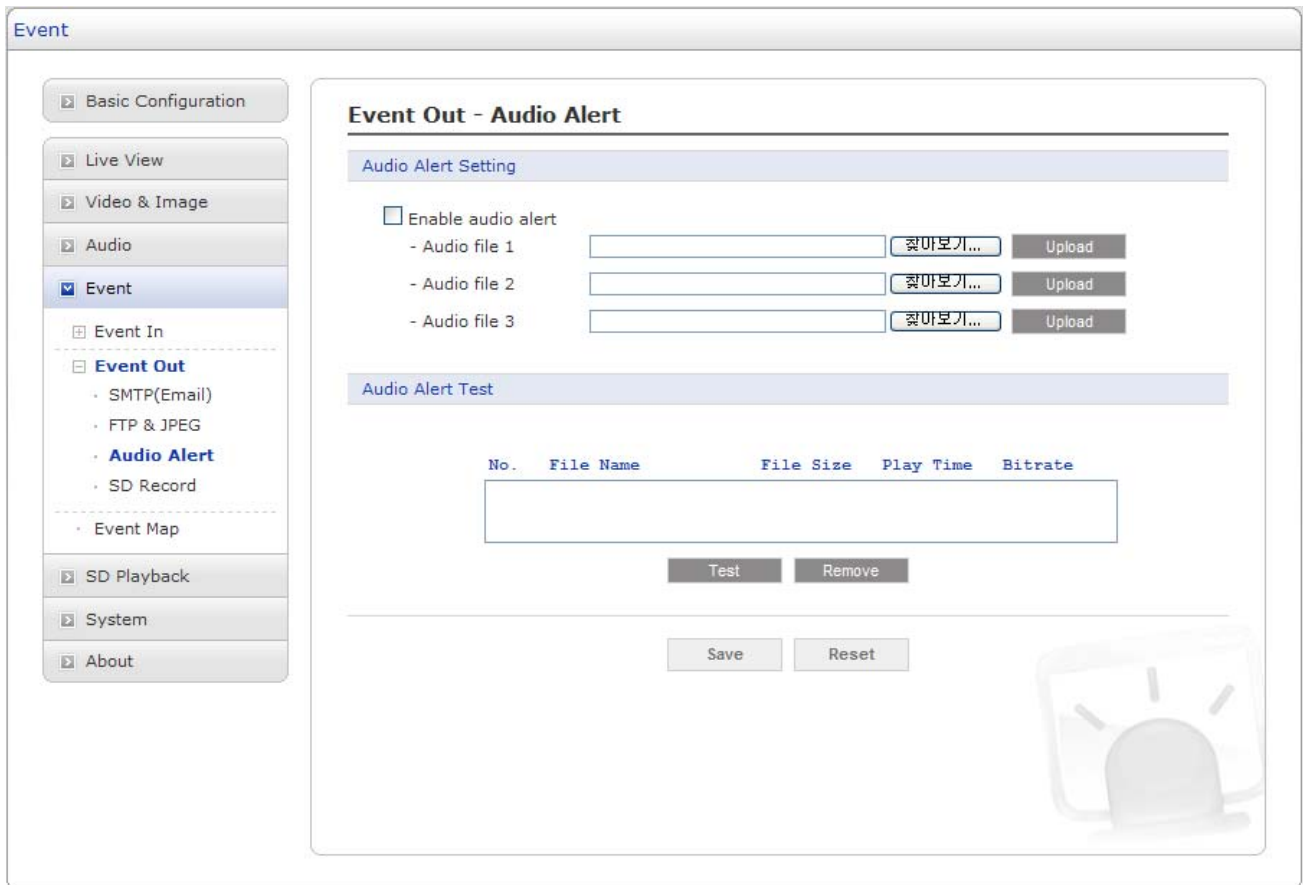

Figure 35. Event / Event Out – Audio Alert.

Audio Alert Setting: To use the audio alert function, an audio data file made by user must be uploaded from your PC. Provide the path to the file directly, or use the **Browse** button to locate it. Then click the **Upload** button. An audio file for Audio Alert can be made by Audio Recorder tool in the NT-Manager16 software.

Audio Alert Test: When the setup is complete, the audio output can be tested by clicking the Test button. To remove an audio file, select index and then click the **Remove** button.

NOTE

For a proper operation of audio alert function, you must check the Enable audio in the Audio setting page.

- Click the Save button to save the settings, or click the Reset button to clear all of the information you entered without saving it.

Audio Recorder

To use Audio Recorder tool to make an audio file for Audio Alert function, you must install the NT-Manager16 on the installation CD at first. The NT-Manager16 program (All Programs>NT-Manager16> NT-Manager16) in your PC, the main window will be displayed as below.

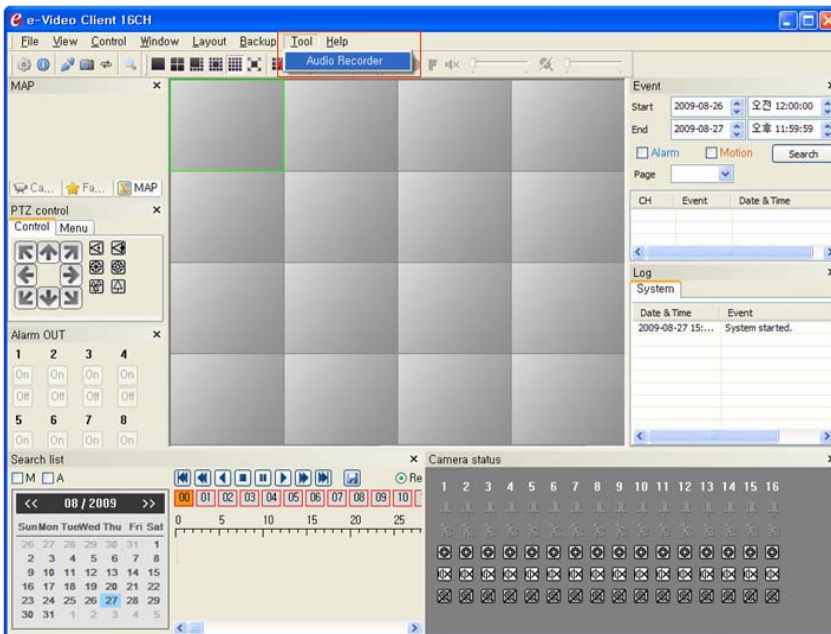

Figure 36. Event / Event Out – Audio Alert / Audio Recorder

Click "Tool" in the menu of the main window and select Audio Recorder to start Audio Recorder. Audio Recorder window will be appeared.

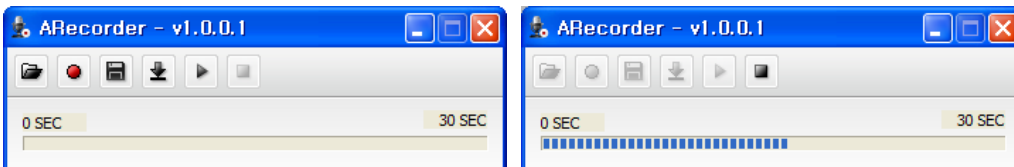







Figure 37. Event / Event Out – Audio Alert / ARecorder window

The description of each button in the ARecorder window follows.

-  Open: Open an audio file.
-  Capture: Capture audio from the microphone in your PC.
-  Save: Save a captured file to your PC. (PCM format)
-  Encode: Encode a current capture file or opened PCM file to G.711 file for Audio Alert.
-  Play: Play a current audio file.
-  Stop: Stop playing audio.

Procedures to make an audio file in G.711 format for Audio Alert.

1. Connect the microphone in your PC.
2. Click the Capture button and talk to the microphone to record the audio or voice.

You can record up to 30 seconds. Click the Stop button to stop on capturing.

3. Click the Save button and then set the file name to save a current capture file with PCM format. If you don't need to make any PCM file, skip this step and then go to the step 5 directly.
4. Click the Open button and then select the file name to open an audio file in PCM format.
5. Click the Encode button to encode a current audio file to G.711 format for Audio Alert. Set the file name and encode parameters.

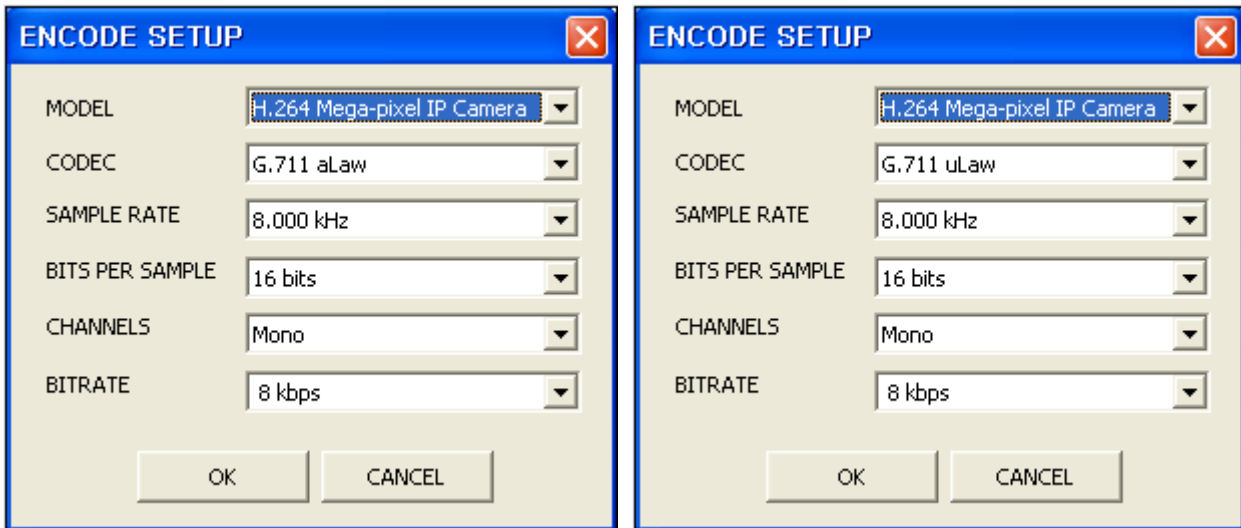

Figure 38. Event / Event Out – Audio Alert / Encode Setup

NOTE

All parameters must be synchronized with ones in audio setting page of network devices for a proper operation.

Event Out – SD Record

When the network camera detects an event such as Alarm or Motion, it records the stream1 according to user settings.

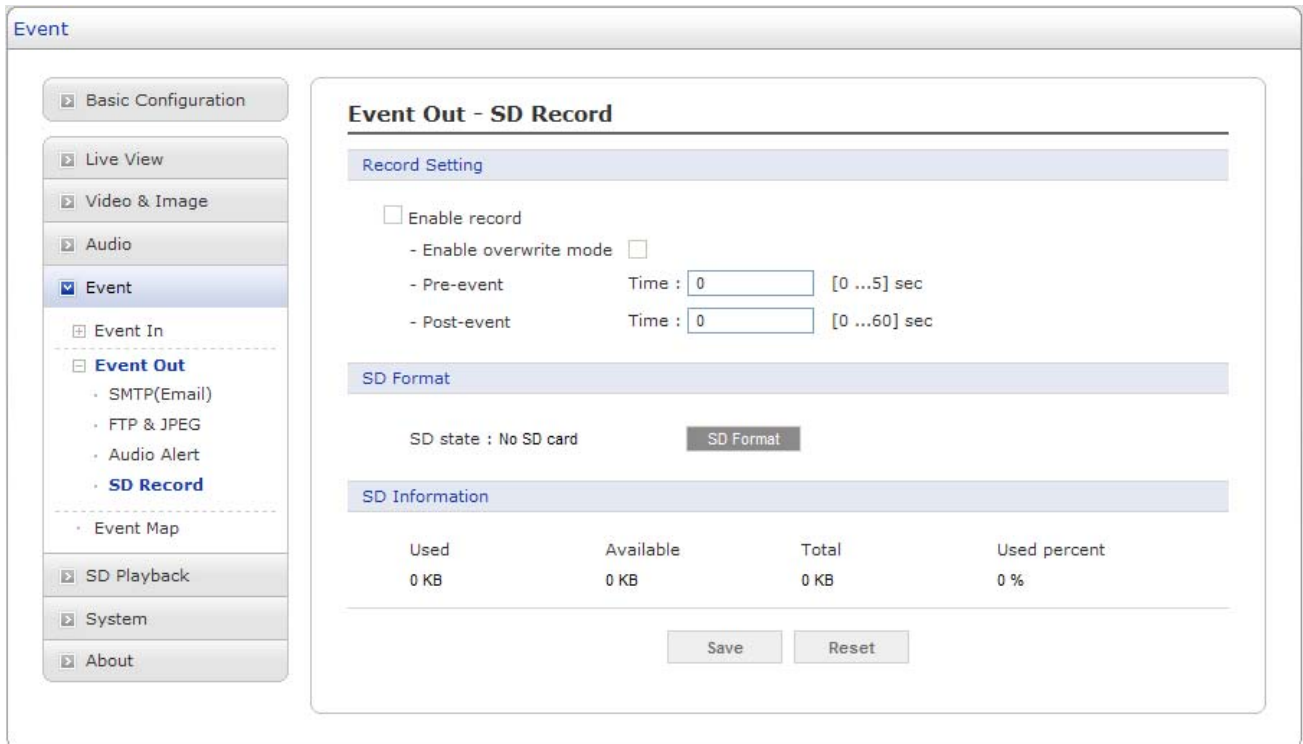

Figure 39. Event / Event Out – SD Record

Record Setting: Click the Enable record checkbox to activate SD recording function.

Enable overwrite mode: Click checkbox to overwrite the SD card

Pre-event: Enter pre-event time value for SD pre-recording.

Post-event: Enter post-event time value for SD post-recording.

SD Format: Shows the SD card status and supports format functionality. If the SD card is not in being, the camera shows "No SD card," whereas if the camera detects SD card, it shows "New (need format)". Every time the new SD card inserted, user needs to format the SD card before recording. If the camera is ready to record, it shows "mount" message.

SD State: Shows the current SD card status in the camera such as No SD card, New(need format), formatting or mount.

SD Format: Click the SD Format dialog box to format SD card.

SD Information: Shows current SD card information.

Event Map

This page shows current configuration status when event is activated.

The common event actions will upload images to a specified destination or send an email or active an output port.

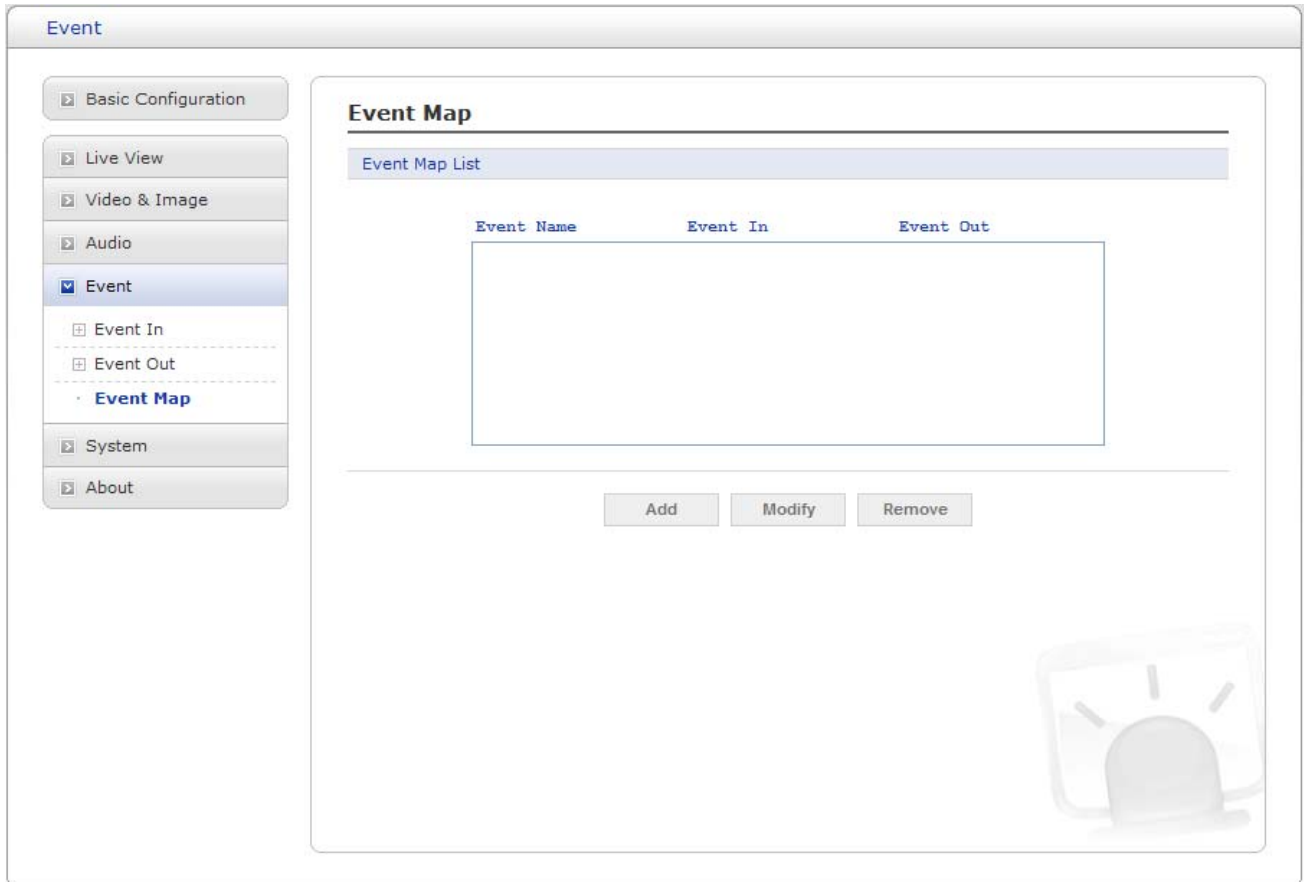

Figure 40. Event / Event Map

Event Map List: An event type is a set of parameters describing how the camera will perform certain actions. Event type may be set up as Triggered according to requirements.

Event Name: Shows the descriptive name provided by the user.

Event In: Shows the source of event type as Alarm-In-1, Alarm-In-2, and VMD configured by the user.

Event Out: Shows the destination of event output as SMTP server, FTP server, Alarm-out port, Audio alert, PTZ preset and SD record..

NOTE

To add new event, click the Add button. This button opens new dialog window, which are used to make all the necessary settings for the new event map.

Add: To add a new event map list, select it and click the Add button.

Modify: To modify an existing event map list, select it and click the Modify button.

Remove: To delete an event map list, select it and click the Remove button.

Event Map - Add

Event Map page provides how to configure the event action if there is event triggering such as Alarm-In and Manual trigger.

Add - Event Map

General

· Name

Event In

· Type

Event Out

Active output port

Email

To email address 1

To email address 2

To email address 3

To email address 4

To email address 5

To email address 6

To email address 7

To email address 8

Subject

Additional Info

[0 / 254]

FTP & JPEG

Audio Alert

Audio file 1 Audio file 2 Audio file 3

SD Record

Figure 41. Event / Event Map – Add

General: Enter the user favorite event name.

Name: Click in the Name box and type a user favorite event name (1 to 31 alphanumeric characters).

Event In: Shows the Event source type to be configured.

Type: Selects the Event source type.

Event Out: The Event Out provides that the camera will perform certain actions.

Active output port: Click the Active output port checkbox to enable the Alarm out port.

Email: Click the Email checkbox to enable the emailing below each email address.

-- **To email address:** Click the each email addresses checkbox.

NOTE

If you want to additional message when emailing, click in the Subject / Additional Info box and type a description for the text you are creating (0 to 255 alphanumeric characters).

FTP & JPEG: Click the FTP & JPEG checkbox to enable the image uploading to FTP server using JPEG image.

Audio Alert: Click the Audio Alert checkbox to enable the Audio Alert function.

PTZ Preset: Click the PTZ Preset checkbox to enable the PTZ Preset function.

SD Record: Click the SD Record checkbox to enable the SD Record function.

- Click the Save button to save the settings, or click the Reset button to clear all of the information you entered without saving it.

SD Playback

This page shows current SD record file lists and information. It also supports how to access the recorded stream in easy way.

Playback List View

User can check the recorded image in the web browser.

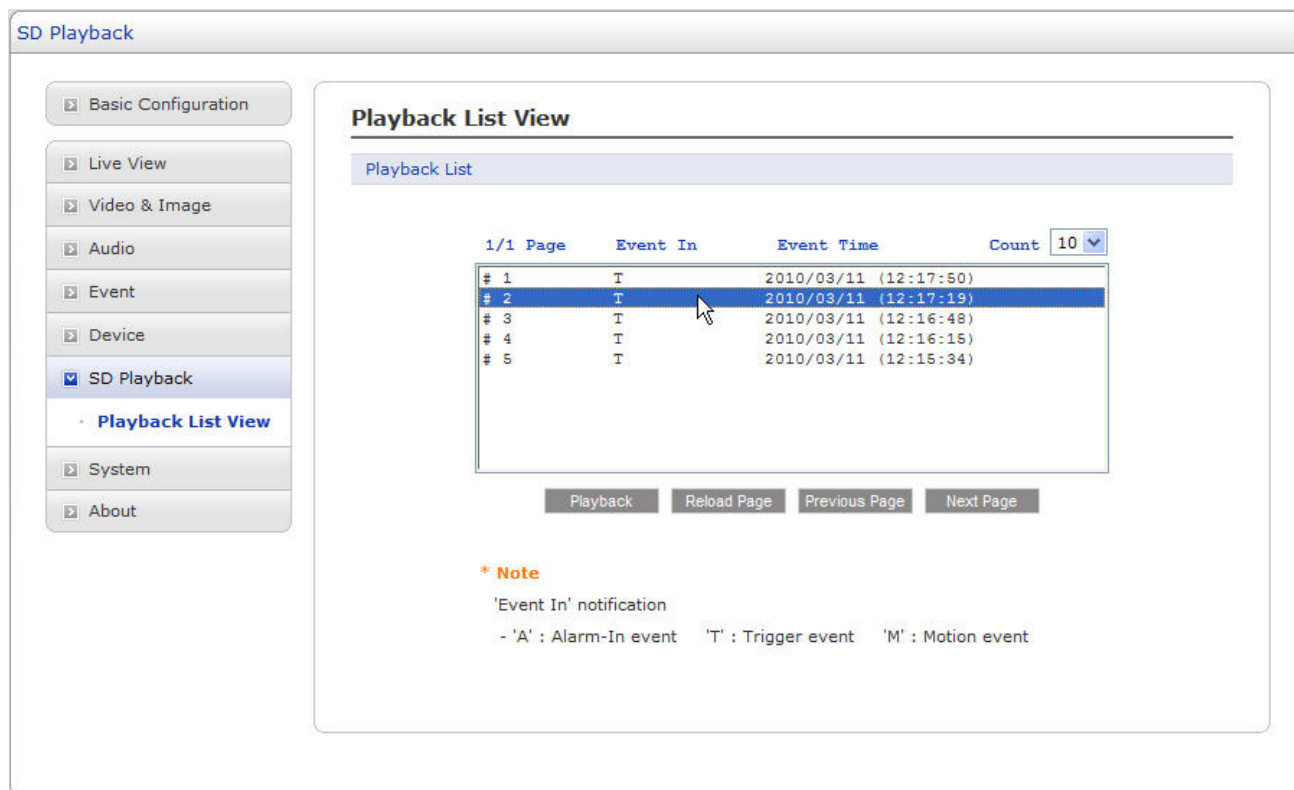

Figure 42. SD Playback / Playback List View

Playback List: Shows the information such as list Page, event type, and event time.

Playback: Click the Playback box to check the recorded image.

Reload Page: Reloads current record lists again according to the Count number.

Previous Page: Shows the previous record lists according to the Count number.

Next Page: Shows the next record lists according to the Count number.

NOTE

The abbreviation of Event In column means that "A" is an Alarm In event, "T" is a manual Trigger event, "M" is a Motion event.

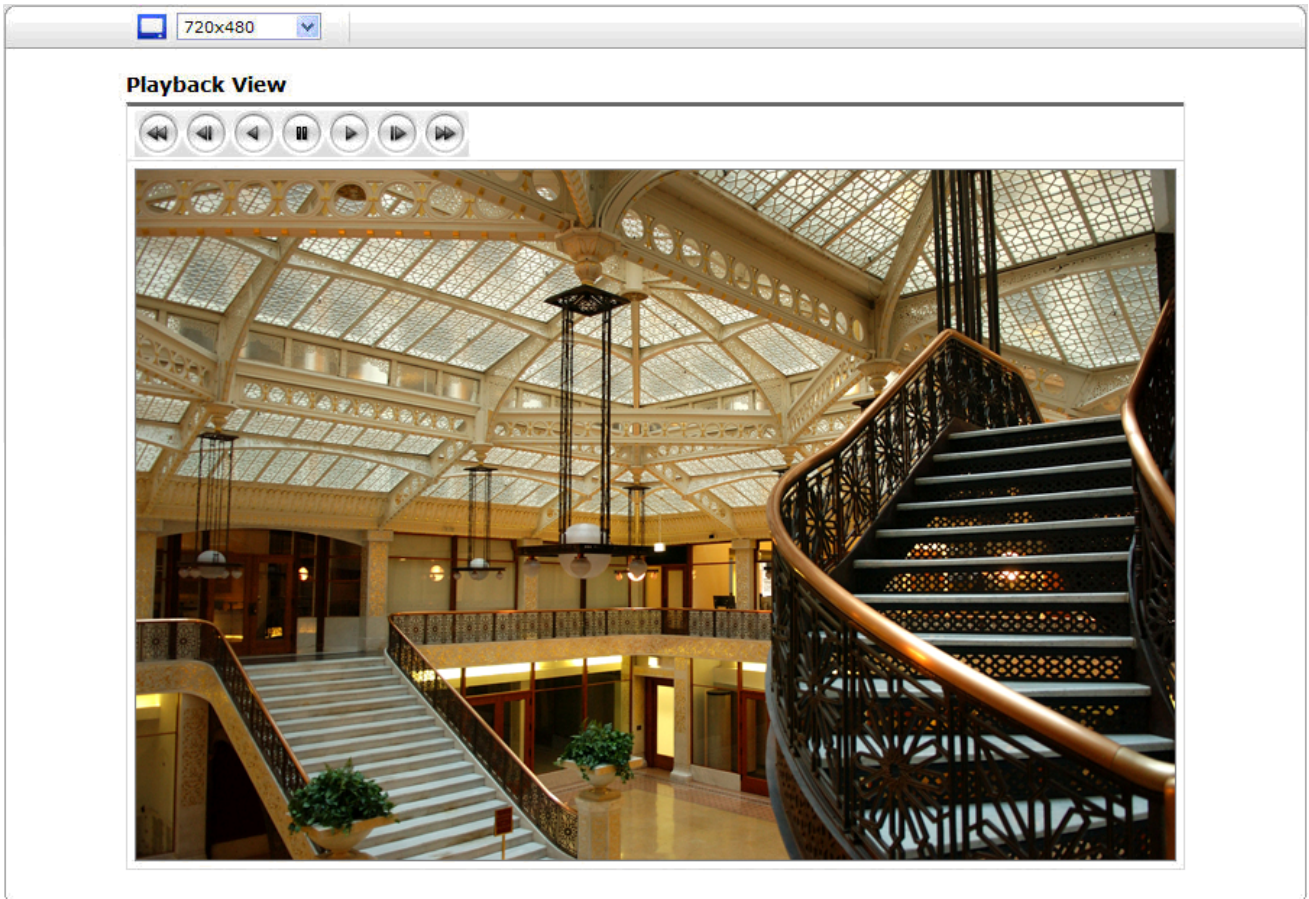

Figure 43. SD Playback / Playback List View - Playback

Playback View: Shows the playback image when user clicks the Playback button box.

-  Fast backward play
-  Backward step
-  Backward play
-  Pause
-  Play
-  Forward step
-  Fast forward play

System

The System tabs features various system information especially network security, advanced network setting parameters, system configurations and maintenance.

Security - Users

Use the Users tab to provide user permission to access the camera and lists User name and User Group accounting.

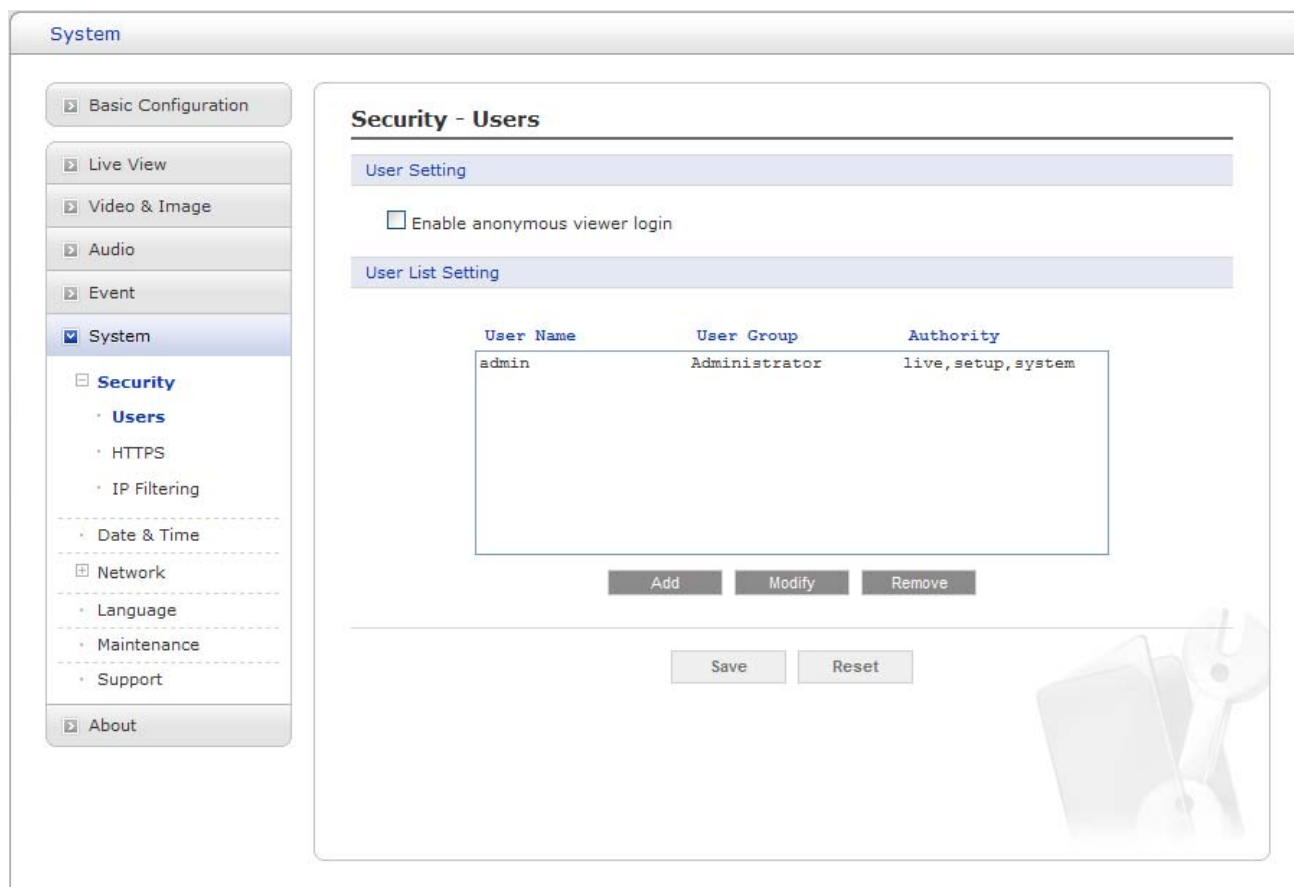

Figure 44. System / Security – Users

User Setting: Click the Enable anonymous viewer login checkbox to permit the anonymous user login to the camera. The default setting is disabled.

User List Setting: User accounts can be added or modified or removed. The authority depends upon user group automatically and shows the permission status to access the menus. The default User Name is **admin** and the password of admin is **admin**.

User Name: Shows the names which registered to access the camera.

User Group: Shows the assigned permissions given to users.

Authority: Shows the permission status to access the menus.

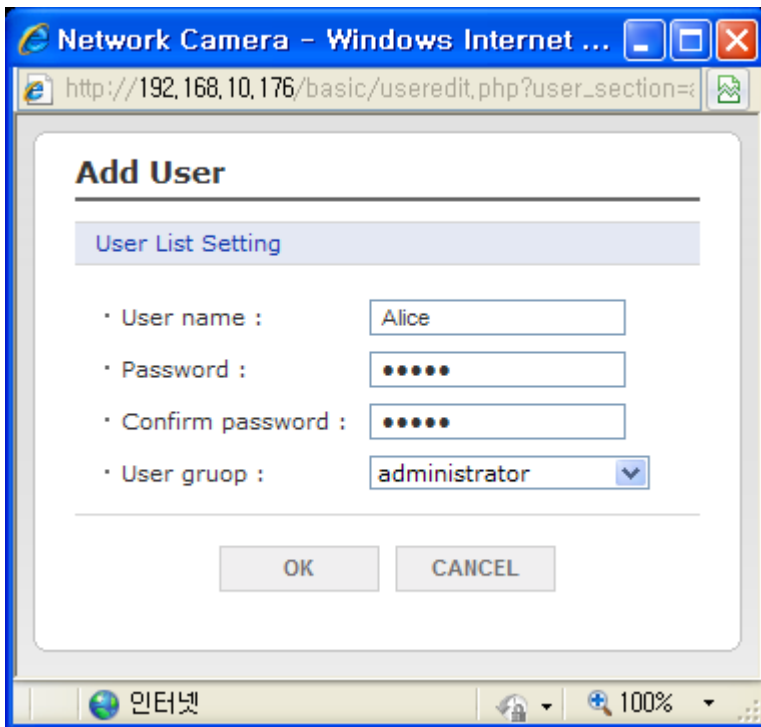

Figure 45. System / Security / Users - Add User

To add a new user:

1. Click the Add tab, and then new pop-up window appears.
2. Click in the User name box and type a new user name (1 to 14 alphanumeric characters). User names are not case sensitive.
3. Click in the Password box and type a password (1 to 8 alphanumeric characters). Passwords are case sensitive.
4. Click in the Confirm password box and retype a password.
5. Click in the User group box and select one of the groups you wish to assign to the user.
6. Click the OK button to save the settings and add a new user.

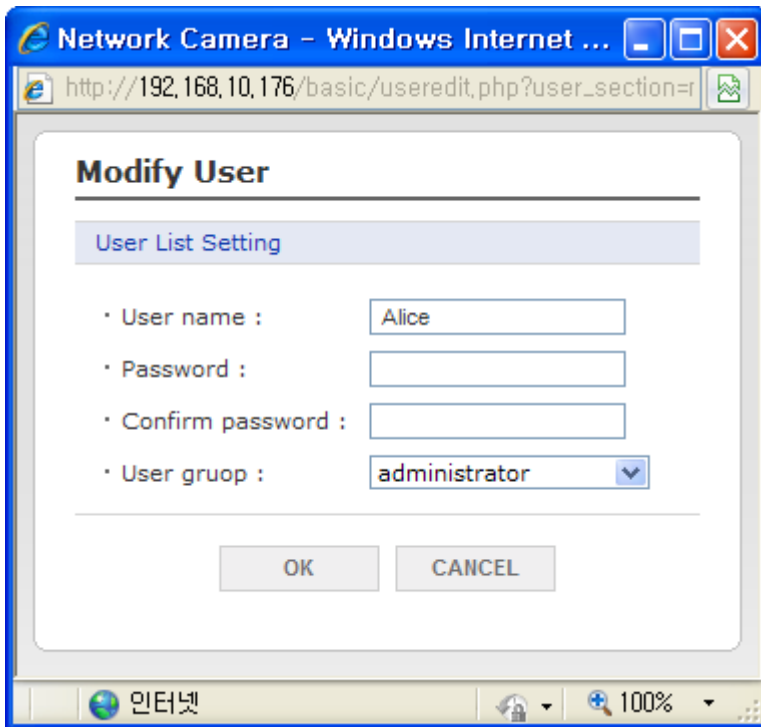

Figure 46. System / Security / Users - Modify User

To modify a user:

1. Select one of the User Name in the User List Setting you want to modify.
2. Click the Modify tab, and then new pop-up window appears.
3. Click in the Password box and type a password (1 to 8 alphanumeric characters). Passwords are case sensitive.
4. Click in the Confirm password box and retype a password.
5. Click in the User group box and select one of the groups you wish to assign to the user.
6. Click the OK button to save the settings and modify a user.

NOTE

The user name can't be modified.

To remove a user:

1. Select one of the User Name in the User List Setting you want to remove.
2. Click the Remove tab. A dialog box appears with confirmation message.
3. Click the OK button. The user profile is removed from the User List Setting profile.

NOTE

The admin user name can't be deleted.

- Click the Save button to save the settings, or click the Reset button to clear all of the information you entered without saving it.

Security - HTTPS

Use the HTTPS tab to allow user access to the camera using web browser encrypted communication.

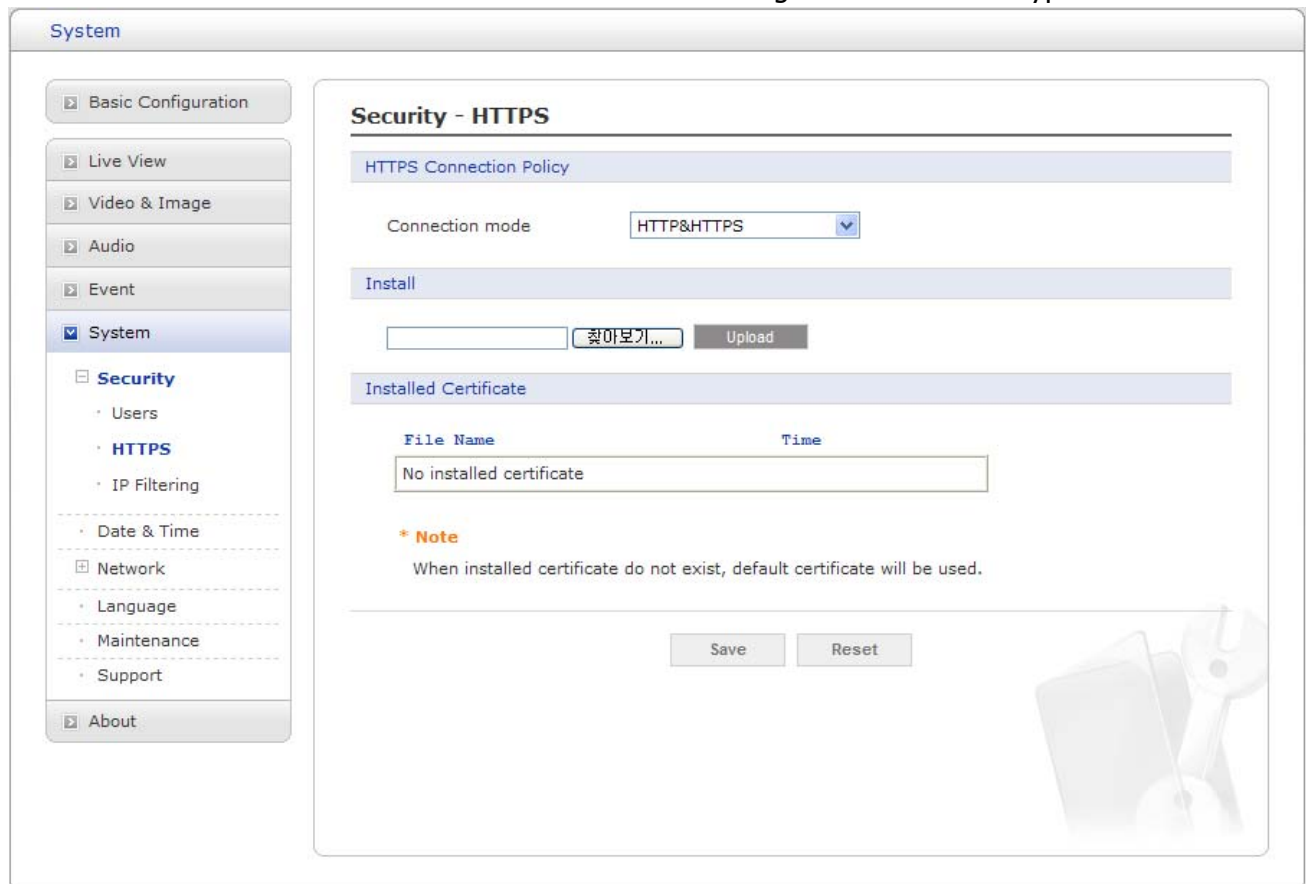

Figure 47. System / Security – HTTPS

HTTPS Connection Policy: Provides the connection policy when user access to the camera using web browser.

Connection mode: The default setting is HTTP&HTTPS.

-- **HTTP:** The sensitive data will be transfer without encrypted during transmission. Supports a URL that only starts with "HTTP:"

-- **HTTPS:** HTTPS (Hypertext Transfer Protocol over SSL) is a protocol used to provide the encrypted transmission. Supports a URL that only starts with "HTTPS:"

-- **HTTP&HTTPS:** Supports both HTTP and HTTPS simultaneously. You can access the camera using a standard "HTTP:" URL, but sensitive data is not encrypted during transmission. To ensure that sensitive data is encrypted, you must use a secure "HTTPS:" URL.

NOTES

- To ensure security on the internet, all web browsers provide several security levels that can be adjusted for site that use SSL (Secure Socket Layer) technology to transfer data. SSL encrypts communications, making it difficult for unauthorized users to intercept and view user names and passwords.
- SSL requires signed certificates to determine if the web browser accessing the camera has a required authentication. This camera can generate a self-signed certificate using Open SSL.

- If you select the HTTP connection policy to HTTP, you cannot access the camera using a URL beginning with "HTTPS:"
- Self-signed certificates are valid for 10 years.

Install: To use HTTPS for communication with the Network Camera, An official certificate issued by a CA (Certificate Authority) must be uploaded from your PC. Provide the path to the certificate directly, or use the Browse button to locate it. Then click the Upload button.

Installed Certificate: In case of all the processing succeed, the name of official certificate will be displayed and also its installed time.

NOTES

Please refer to the home page of your preferred CA for information on where to send the request. For more information, please see the online help.

- Click the Save button to save the settings, or click the Reset button to clear all of the information you entered without saving it.

Security – IP Filtering

Use the IP Filtering tab to activate the IP address filtering function that decides which IP address will be allowed normally and which will be denied.

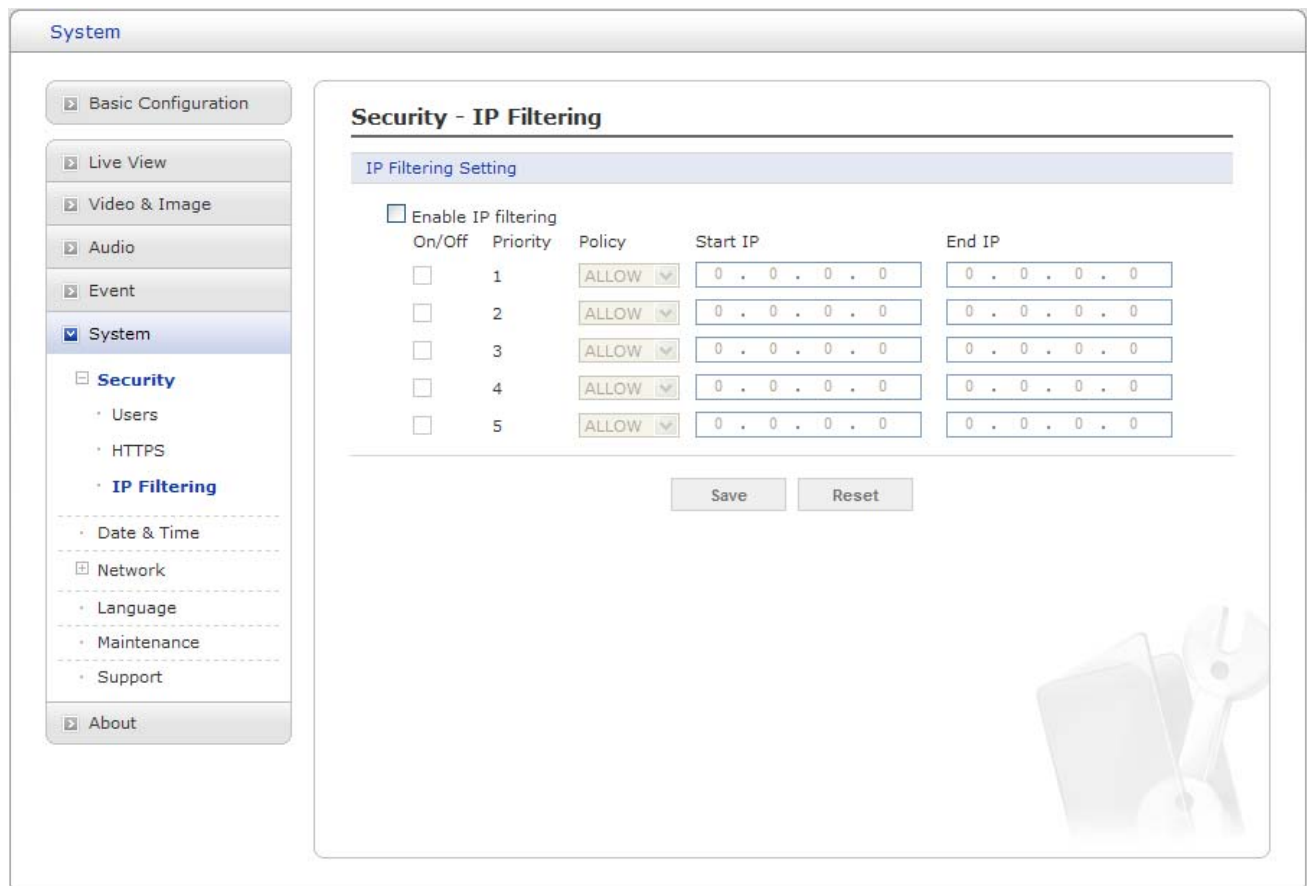

Figure 48. System / Security – IP Filtering

IP Filtering Setting: Provides the IP filtering elements such as On/Off, Priority, Policy and IP Ranges. The default setting is disabling.

Enable IP filtering: Click the Enable IP filtering checkbox to enable the IP address filtering function. This dialog allows you to add new allowed/denied IP addresses. These can be added whole ranges (subnets) of IP address can be added directly.

On/Off: Click the checkbox to active the settings (Priority, Policy, and IP ranges).

Priority: The number means a priority if there are duplicated IP address each IP ranges.

Policy: Determines the filtering attribute of the IP address selected.

Start IP: Enters the start IP address to ALLOW/ DENY in the IP range selected.

End IP: Enters the end IP address to ALLOW/ DENY in the IP range selected.

NOTES

- To add a subnet of network addresses, these must be added in CIDR (Classless Inter-Domain Routing) notation.

For example: entering 192.168.1.0/24 will add all the addresses in the range 192.168.1.1 to 192.168.1.254. Please contact with your network administrator for more detail.

- If you are accessing the network camera via a proxy server, the IP address for the proxy server must be added as an allowed address.

- Click the Save button to save the settings, or click the Reset button to clear all of the information you entered without saving it.

Date & Time

Use the Date and Time tab to set the camera's date and time values, manually or automatically.

The screenshot displays the 'System / Date & Time' configuration interface. On the left is a navigation menu with options like 'Basic Configuration', 'Live View', 'Video & Image', 'Audio', 'Event', 'SD Playback', 'System' (selected), 'Security', 'Network', 'Language', 'Maintenance', 'Support', and 'About'. The main content area is titled 'Date & Time' and is divided into several sections:

- Current Server Time:** Shows 'Date : 2010-03-15' and 'Time : 00:10:29'.
- New Server Time:** Includes a dropdown for '(GMT) Greenwich Mean Time : Dublin, Edinburgh, Lisbon, London' and a checkbox for 'Automatically adjust for daylight saving time changes'.
- Time mode:** Three radio buttons are present: 'Synchronize with computer time' (unselected), 'Synchronize with NTP server' (unselected), and 'Set manually' (selected). Under 'Set manually', there are input fields for 'Date Format : 2010-03-15' and 'Time Format : 00:10:21'. Under 'Synchronize with NTP server', there are fields for 'NTP server : time.nist.gov' and 'NTP Interval : 1 [hour]'.
- Date & Time Format:** Shows 'Date Format : YYYY-MM-DD' and 'Time Format : 24 hour'.

At the bottom of the configuration area are 'Save' and 'Reset' buttons.

Figure 49. System / Date & Time

Current Server Time: Shows the current date and time.

Date: The default setting is 1970-01-01.

Time: The default setting is 00:00:00.

New Server Time: Select the time zone where your camera is located.

Click the Automatically adjust for daylight saving changes checkbox to automatically update the time changes caused by daylight saving.

Time zone: The default setting is GMT.

Time mode: The default setting is Set manually.

Synchronize with computer time: Sets the time according to the clock on your computer.

Synchronize with NTP Server: This option will obtain the correct time from an NTP server every 60 minutes. The NTP server's IP address or host name is specified in the time server.

Set manually: Using this option allows you to manually enter the date and time.

Date & Time Format: Select one of the Date and Time format.

Date Format: The default setting is YYYY-MM-DD.

Time Format: The default setting is 24 hours.

- Click the Save button to save the settings, or click the Reset button to clear all of the information you entered without saving it.

Network

Contact with your network administrator to avoid any network conflicts before setting or changing the IP address of the camera.

Network - Basic

Use the Network-Basic tab to manage the network settings.

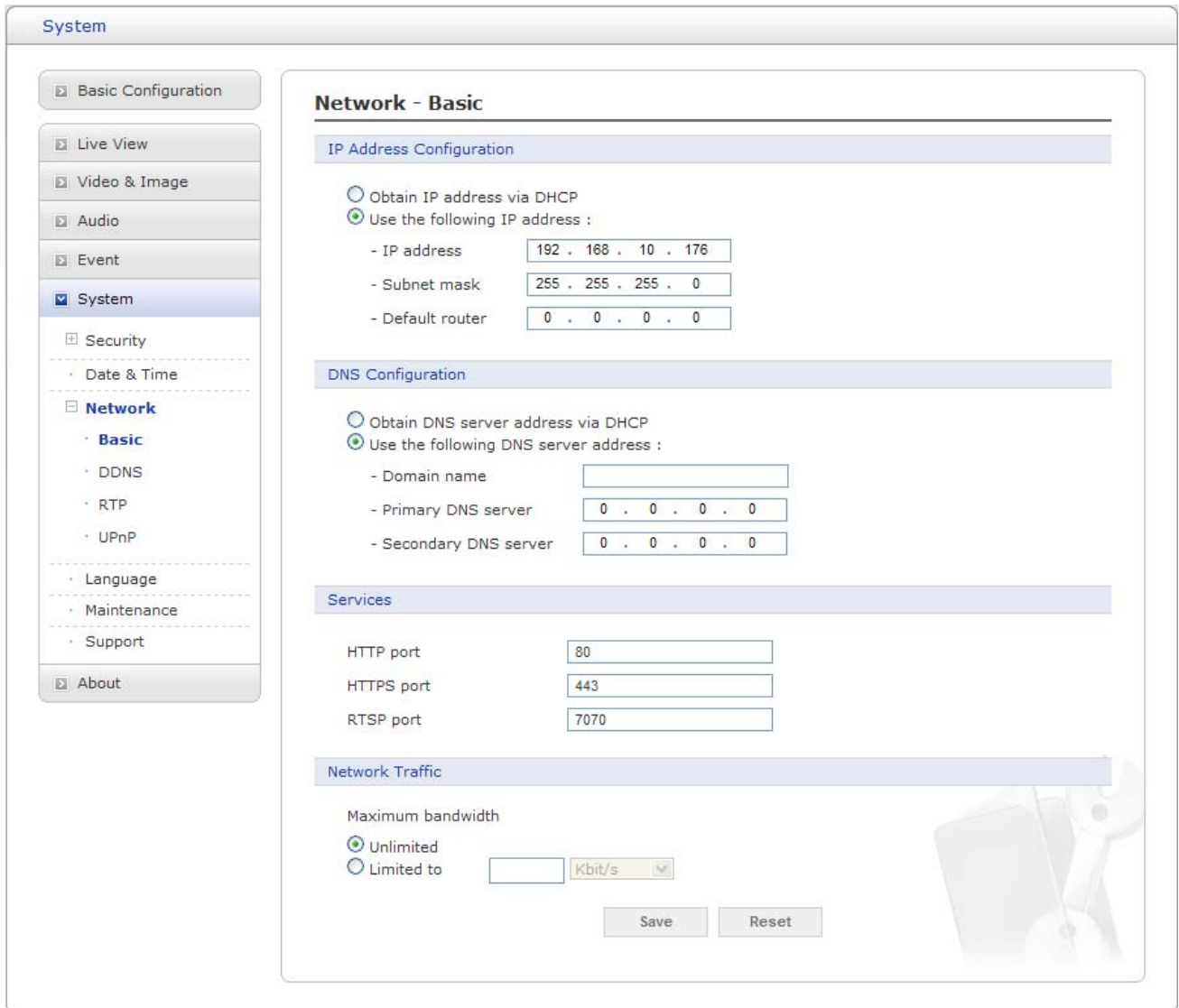

Figure 50. System / Network – Basic

IP Address Configuration: The DHCP (Dynamic Host Configuration Protocol) server has a feature that automatically assigns an IP address to the device if there is a device on the network.

Obtain IP address via DHCP: Select the choice box if you want to assign the IP address from DHCP server automatically, and then the remaining settings are read-only text.

Use the following IP address: Select the choice box if you want to assign the IP address manually.

IP address: The address of the camera connected to the network. Specify a unique IP address for this network camera.

Subnet mask: The address that determines the IP network that the camera is connected to (relative to its address). Specify the mask for the subnet the network camera is located on.

Default router: The router that accesses other networks. Specify the IP address of the default router (Gateway) used for connecting devices attached to different networks and network segments.

DNS Configuration: DNS (Domain Name Service) provides the translation of host names to IP addresses on your network.

Obtain DNS server via DHCP: Select the choice box if you want to use the DNS server settings provided by the DHCP server automatically, and then the remaining settings are read-only text.

Use the following DNS server address: Select the choice box if you want to use the desired DNS server manually.

Domain name: Enter the domain to search for the host name used by the network camera.

Primary DNS server: Enter the IP address of the primary DNS server.

Secondary DNS server: Enter the IP address of the secondary DNS server.

Services: Allows the user to access the camera using web browser encrypted communication.

HTTP port: The default HTTP (Hypertext Transfer Protocol) port number is 80 and can be changed to any port within the range 1024-65535.

HTTPS port: The default port number is 443 and can be changed to any port within the range 1024-65535.

RTSP port: RTSP (Real Time Streaming Protocol) allows a connecting client to start a video stream. The default setting is 7070 and can be changed to any port within the range 1024-65535.

Network Traffic: Specify the maximum bandwidth of this camera. This is a useful function when connecting the camera to busy or heavily loaded networks. The default setting is Unlimited.

Unlimited: Provides consistently good image quality at the expense of increased bandwidth and storage usage during low light.

Limited to: Provides the optimized bandwidth and storage usage, but gives poor image quality. To prevent increased bandwidth and storage usage, the optimized bandwidth should be set.

- Click the Save button to save the settings, or click the Reset button to clear all of the information you entered without saving it.

Network – DDNS

The DDNS (Dynamic DNS) service can provide the camera with its own URL (web address), which can then be used to access it over the Internet. Use the DDNS service to assign a host name for easy access to your network camera.

NOTES

- If the camera has not previously been registered at the Dynamic DNS Service, you need the registration process first. You will then need to visit ***http://www.security-device.name*** to complete the process.
- If the camera is already registered at the Dynamic DNS Service and its IP address changes, the DNS service must be updated with this new IP address.
- These regular updates will always occur at the set interval, with no regard to whether automatic updates have been configured or not.

The screenshot shows the 'System / Network - DDNS' configuration interface. On the left is a sidebar with a tree view containing: System (selected), Security, Date & Time, Network (expanded), Basic, DDNS (selected), RTP, UPnP, Language, Maintenance, Support, and About. The main panel is titled 'Network - DDNS' and contains the 'Internet DDNS(Dynamic Domain Name Service)' section. It features a checkbox for 'Enable DDNS'. Below it is a note: '* Note: Please remember you have to configure at least primary DNS server in DNS configuration settings to use Dynamic DNS.' The configuration fields include: 'DDNS server' (dropdown menu with 'security-device.name' selected), 'Registered host' (text input), 'User name' (text input), 'Password' (text input), 'Confirm password' (text input), and 'Maximum time interval' (dropdown menu with '10 min' selected). At the bottom of the form is a checkbox for 'Register local network IP address' and two buttons: 'Save' and 'Reset'. A faint watermark of a camera and tools is visible in the bottom right corner of the interface.

Figure 51. System / Network – DDNS

Internet DDNS (Dynamic Domain Naming Service): Provides user with host name to access the camera.

Enable DDNS: Click the Enable DDNS checkbox to active DDNS service.

DDNS server: Enter the DDNS server name. The default DDNS server is security-device.name

Registered host: Enter the registered host name.

User name: Enter the registered user name to be used for accessing the DDNS server.

Password: Enter user password to be used for accessing the DDNS server.

Confirm password: Enter user password again to confirm.

Maximum time interval: Set the interval at which to regularly update the Dynamic DNS service. The default setting is 10 minutes.

Register local network IP address: Register a network camera IP address to the DDNS server.

- Click the Save button to save the settings, or click the Reset button to clear all of the information you entered without saving it.

Network – RTP

These RTP settings concern the IP addresses and port numbers to use for video and audio stream(s).

The screenshot shows a web interface for configuring RTP settings. On the left is a navigation menu under the 'System' tab, with 'Network' expanded to show 'RTP'. The main content area is titled 'Network - RTP' and contains two sections: 'Port Range' and 'Multicast'. The 'Port Range' section has 'Start port' set to 5008 and 'End port' set to 50999, both with a note that only even values are available. The 'Multicast' section has an unchecked 'Enable multicast' checkbox, a 'Multicast destination IP' of 231.1.128.20, an 'RTP port' of 5000, and an 'RTP TTL' of 1. At the bottom are 'Save' and 'Reset' buttons. A faint image of a camera and tools is visible in the bottom right corner of the interface.

Figure 52. System / Network – RTP

Port Range: The RTP Port range TTL defines the range of ports from which the video/audio ports are automatically selected. This feature is useful if the camera is connected to a NAT router with manually configured port mapping.

NOTE

Limit the range of ports permitted for RTP unicast/multicast by entering the Start port and End port in the provided fields.

Start port: The Start port can be entered in the range 1024-65532. The default setting is 5008.

End port: The End port can be entered in the range 1024-65532. The default setting is 50999.

Note

The video/audio ports entered here must be even values.

Multicast:

Only IP addresses within certain ranges can be used for multicasting. The camera has been pre-configured with addresses from these ranges, and does not normally need to be reconfigured. If an address does need to be changed, please contact your network administrator.

Multicast destination IP: Click in the Multicast destination IP box and type IP address.

NOTES

- Multicast addresses are allocated according to these IANA policies.
- The default setting IP address is ***231.1.128.20***

RTP port: The RTP port can be entered in the range 1024-65532. The default setting is 5000.

NOTE

The RTP port entered here must be even values.

RTP TTL: The RTP TTL can be entered in the range 1-255. The default setting is 1.

NOTES

- TTL (Time To Live) If IP packets (i.e. data) fail to be delivered to their destination within a reasonable length of time (which could be for various reasons), this setting tells network routers when to discard the packet.
- The value is usually measured in 'hops', i.e. the number of network routers that can be passed before the packet arrives at its destination or is dropped.

- Click the Save button to save the settings, or click the Reset button to clear all of the information you entered without saving it.

Network – UPnP

UPnP is enabled by default, and the network camera then is automatically detected by operating systems and clients that support this protocol.

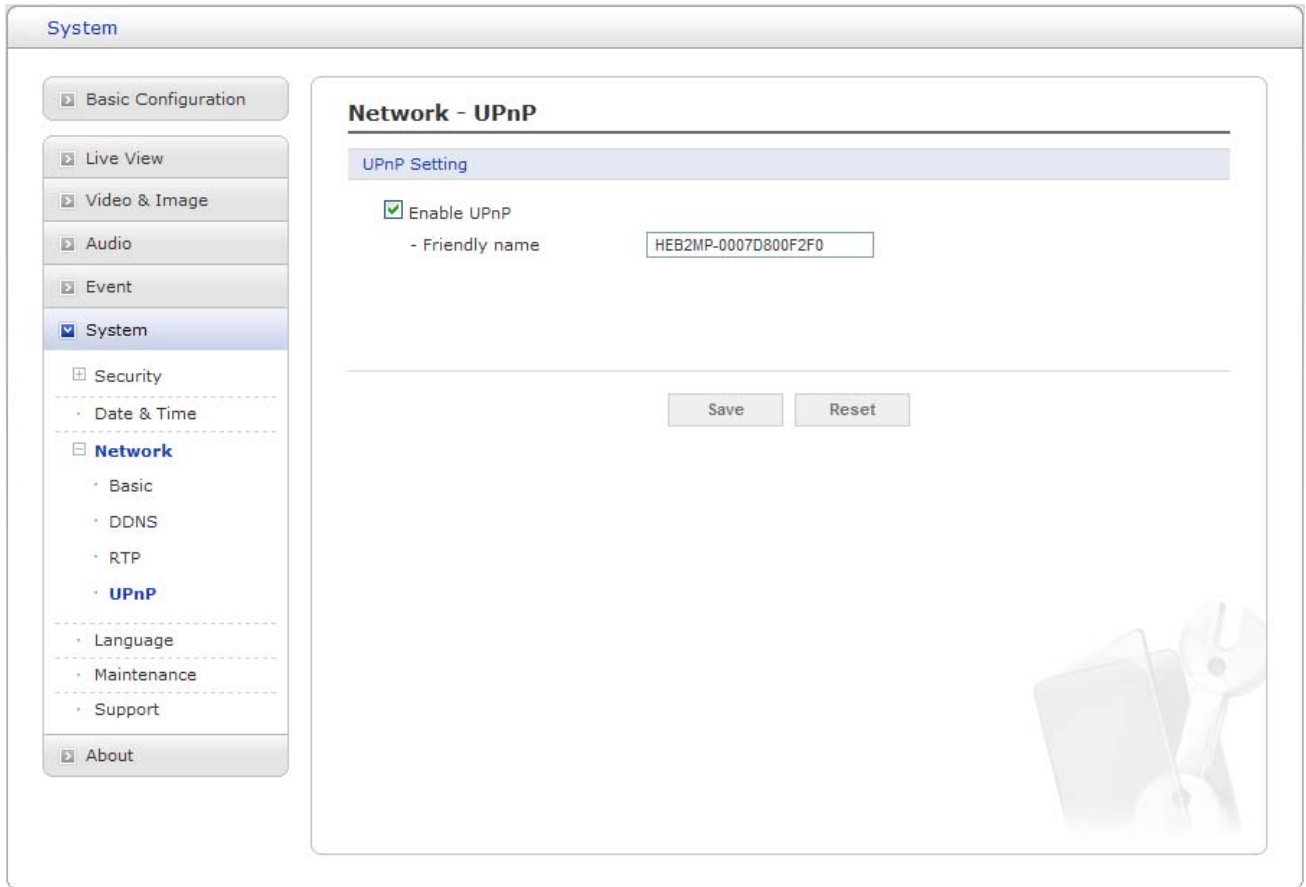

Figure 53. System / Network – UPnP

UPnP Setting: Click the Enable UPnP checkbox to disable the UPnP. The default setting is enabling.

Friendly name: Click in the Friendly name box and type a description for the text you are creating (1 to 32 alphanumeric characters). If your computer is also enabled, the camera is automatically detected and a new icon is added to “Model Name-MAC address”.

NOTE

UPnP must also be enabled on your Windows XP computer. To do this, open the Control Panel from the Start Menu and select Add/Rename programs. Select Add/Remove Windows Components and open the Networking Services section. Click Details and then select UPnP as the service to add.

- Click the Save button to save the settings, or click the Reset button to clear all of the information you entered without saving it.

Network – QoS

Quality of Service (QoS) provides the means to guarantee a certain level of a specified resource to selected traffic on an IP network. Quality can be defined as e.g. a maintained level of bandwidth, low latency, no packet losses, etc.

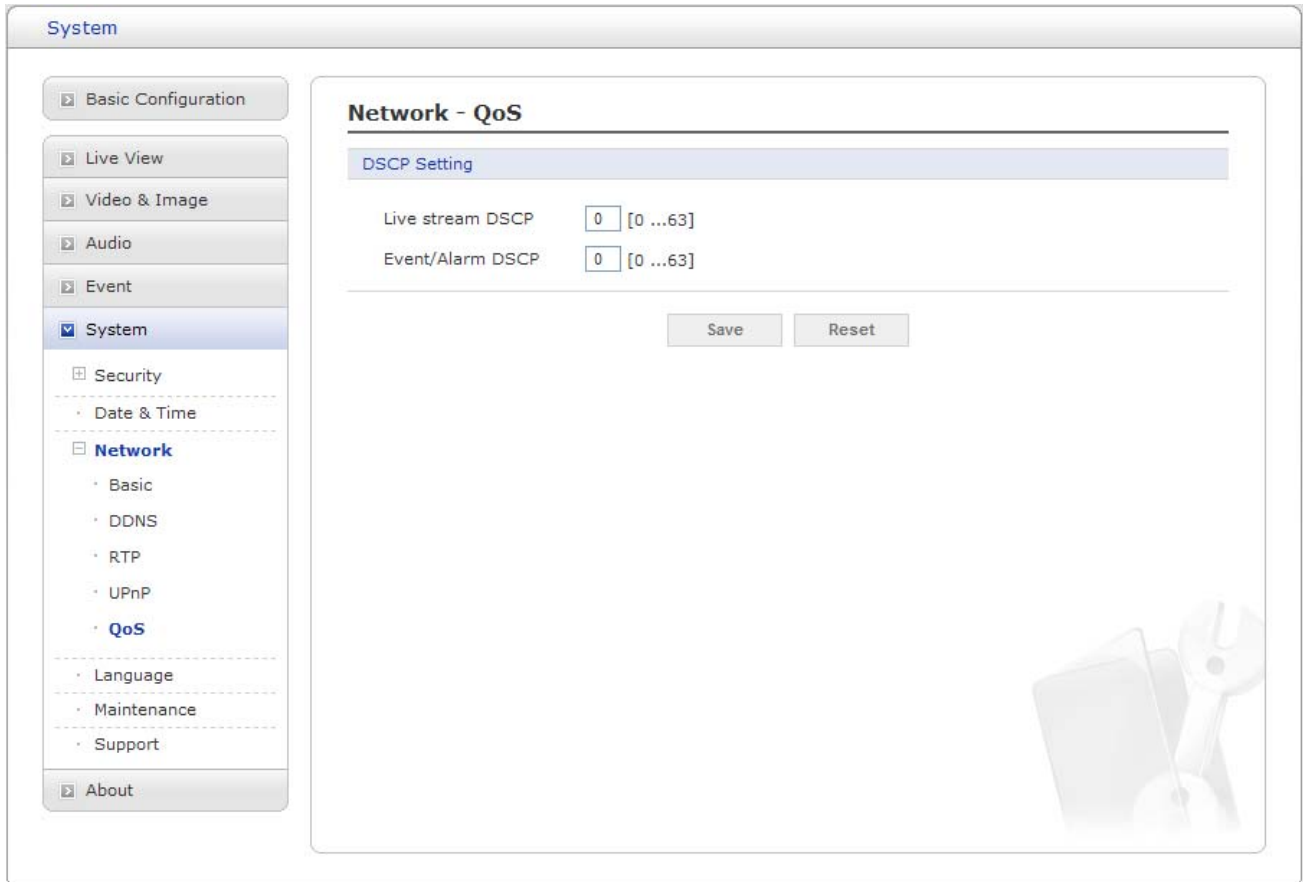

Figure 54. System / Network – QoS

DSCP Setting

For each of the supported types of network traffic, enter a value for the **DSCP** (Differentiated Services Code Point) field in the data packet's IP header. This value marks the network traffic so that network routers know which service(s) to apply to the packet, for example, the amount of bandwidth reserved for the type of traffic.

The QoS in the NXD Series Network Camera marks the data packets belonging to various types of network traffic originating from the unit. QoS-enabled network routers and switches then use these markings to apply particular treatment to these types of traffic, for example, to reserve a fixed amount of bandwidth.

The types of traffic that can be marked are video, audio, event/alarm traffic and management network traffic.

NOTES

The main benefits of a QoS-aware network can be summarized as:

- The ability to prioritize traffic and thus allow critical flows to be served before flows with lesser priority.
- Greater reliability in the network, thanks to the control of the amount of bandwidth an application may use, and thus control over bandwidth races between applications.
- Click the Save button to save the settings, or click the Reset button to clear all of the information you entered without saving it.

Language

Use the Language tab to configure the language supported.

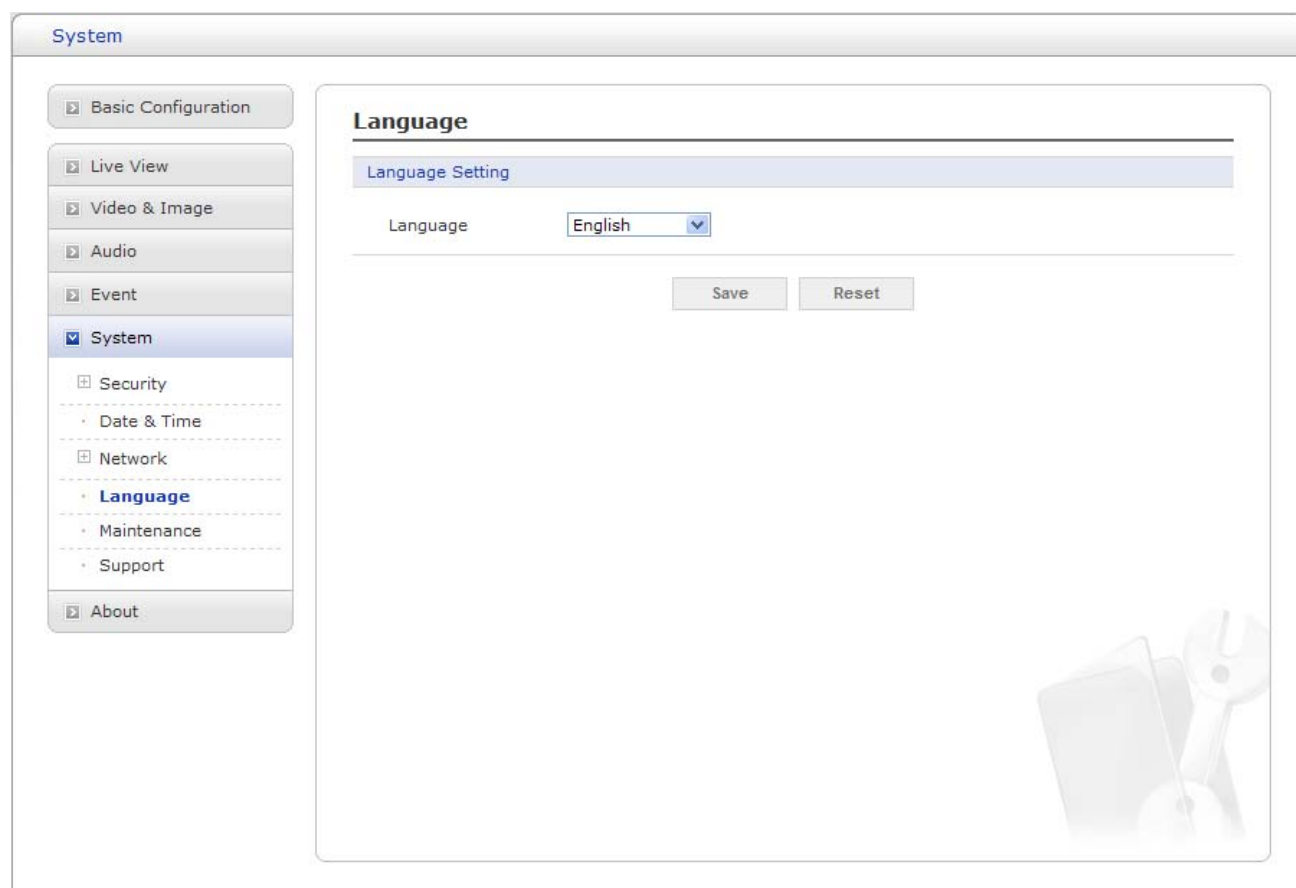

Figure 55. System / Language

Language Setting: Provides the option of language supported.

Language: The default setting is English.

- Click the Save button to save the settings, or click the Reset button to clear all of the information you entered without saving it.

Maintenance

Use Maintenance tab to maintain the camera especially software reset, upgrade, backup parameters and restore parameters.

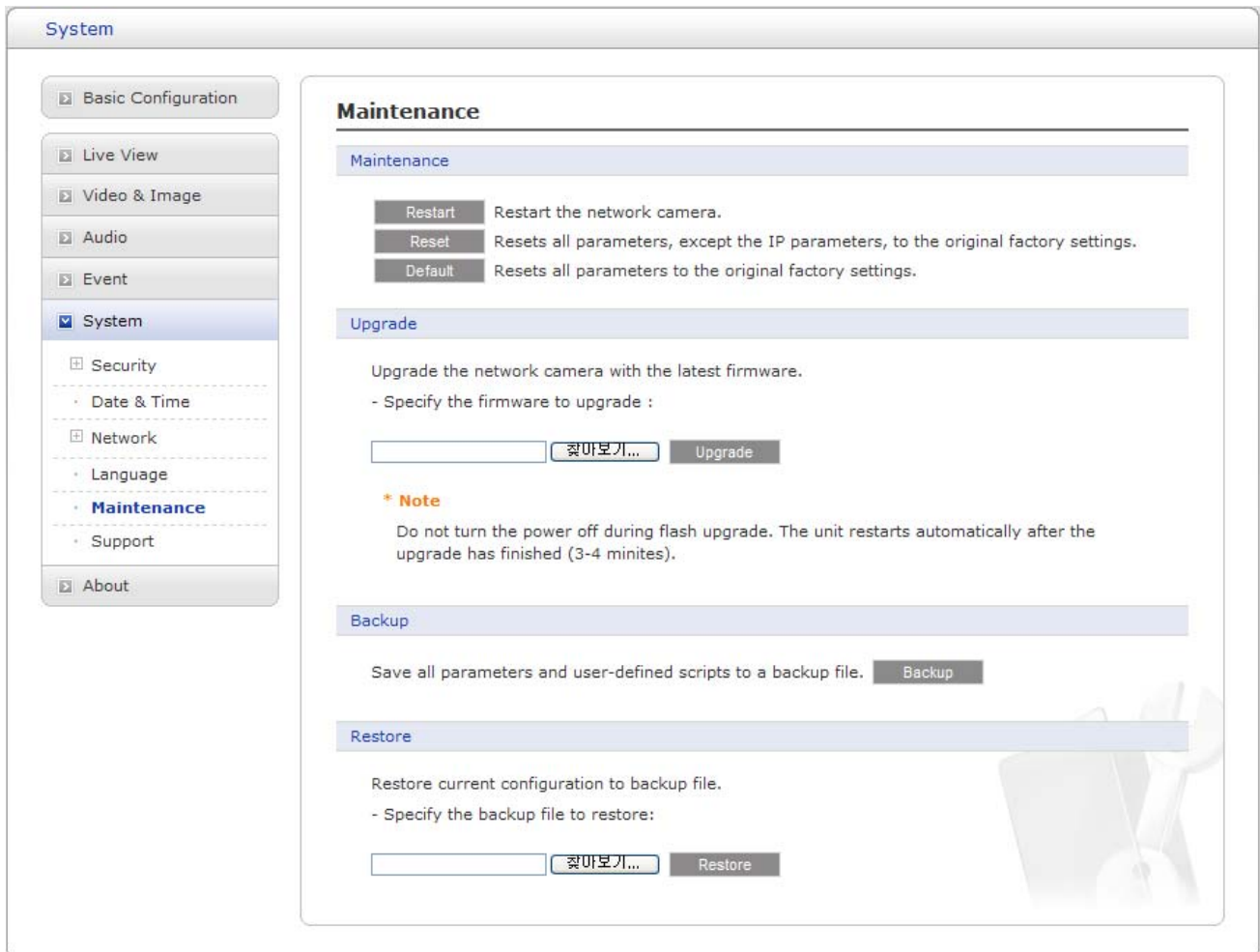

Figure 56. System / Maintenance

Maintenance: Provides software reset of the camera when troubleshooting.

Restart: The camera is restarted without changing any of the setting. Use this method if the unit is not behaving as expected.

Reset: The unit is restarted and most current settings are reset to factory default values, but the following settings does not reset.

- The boot protocol (DHCP or static)
- The static IP address
- The default router
- The subnet mask
- The system time

Default: The Default button should be used with caution. Pressing this returns the camera's settings to the factory default values including the IP address.

Upgrade: Provides the latest firmware into this camera. When you upgrade the firmware with a file, your camera receives the latest available functionality and unparalleled reliability.

NOTE

Always read the upgrade instructions and release notes before upgrading the firmware.

Upgrade: Upgrades the new firmware as follows.

1. Save the firmware file to your computer.
2. Browse to the desired firmware file on your computer.
3. Click the Upgrade button.

NOTES

- Do not disconnect power to the unit during the upgrade. The unit restarts automatically after the upgrade has completed. (3-4 minutes)
- After starting the upgrade process, always wait about 3-4 minutes before restarting the camera, even if you suspect the upgrade has failed.

Backup: Save all parameters and user-defined scripts to a backup file.

Backup: Click the Backup button to take a backup of all the parameters, and any user-defined script.

Restore: Use a saved backup file to return the unit to a previous configuration.

Restore: Click the Browse button to locate the saved backup file and then click the Restore button.

NOTE

Backup and Restore can only be used on the same unit with running the same firmware. This feature is not intended for the configuration of multiple units or for firmware upgrades.

Support

The Log and Reports provides variable information on troubleshooting and contact information, should you require technical assistances.

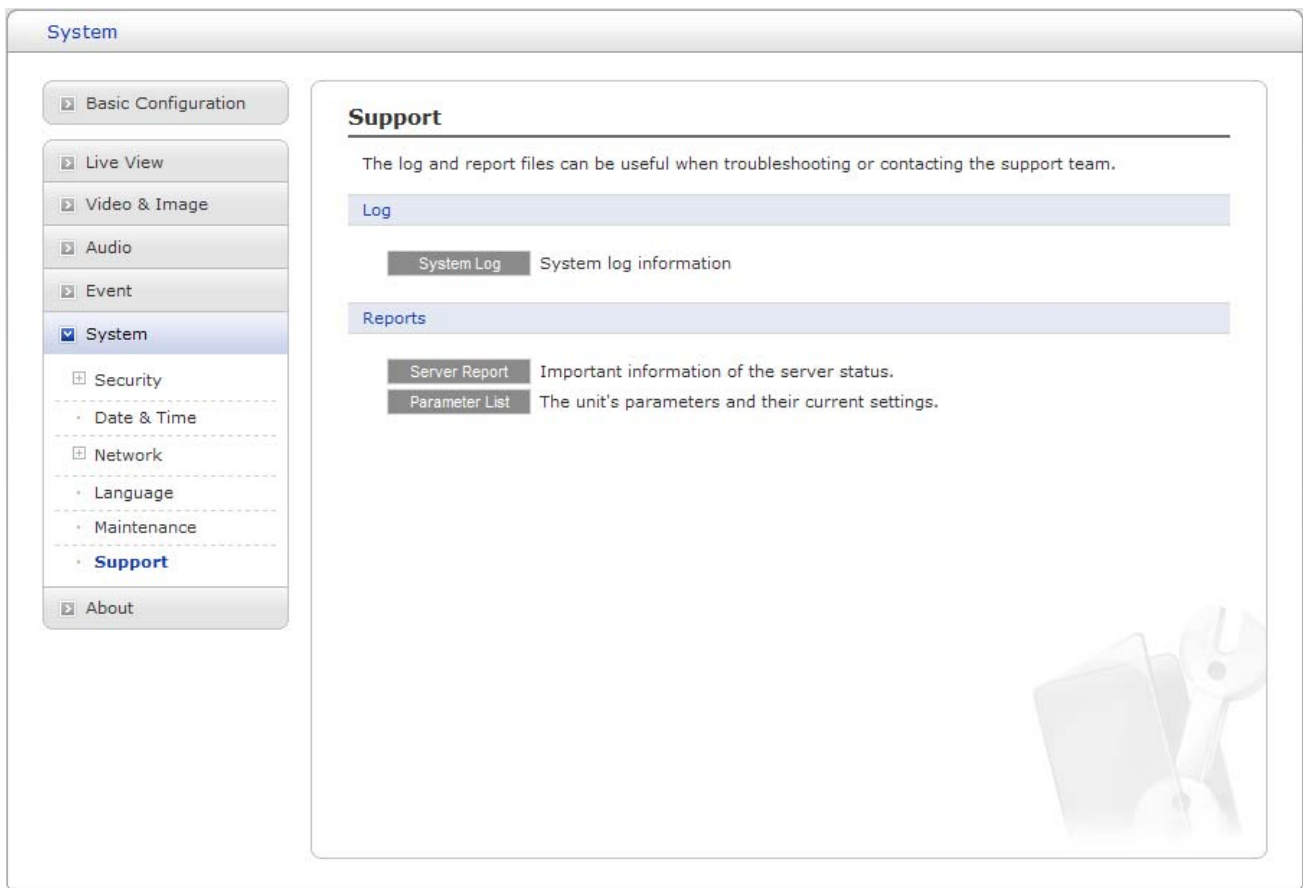

Figure 57. System / Support

Log: The log file records event in the unit since the last system restart and can be a useful diagnostic tool when troubleshooting.

System Log: Provides information about system events.

Reports: The Report contains important information about the server.

Server Report: Provides information about the server status and should be included when requesting report. Information be found here includes the camera’s firmware version, MAC address, system information, IP address and network connections.

Parameter List: Shows the server’s parameters and their current settings.

About

Here you can find basic information about this camera.

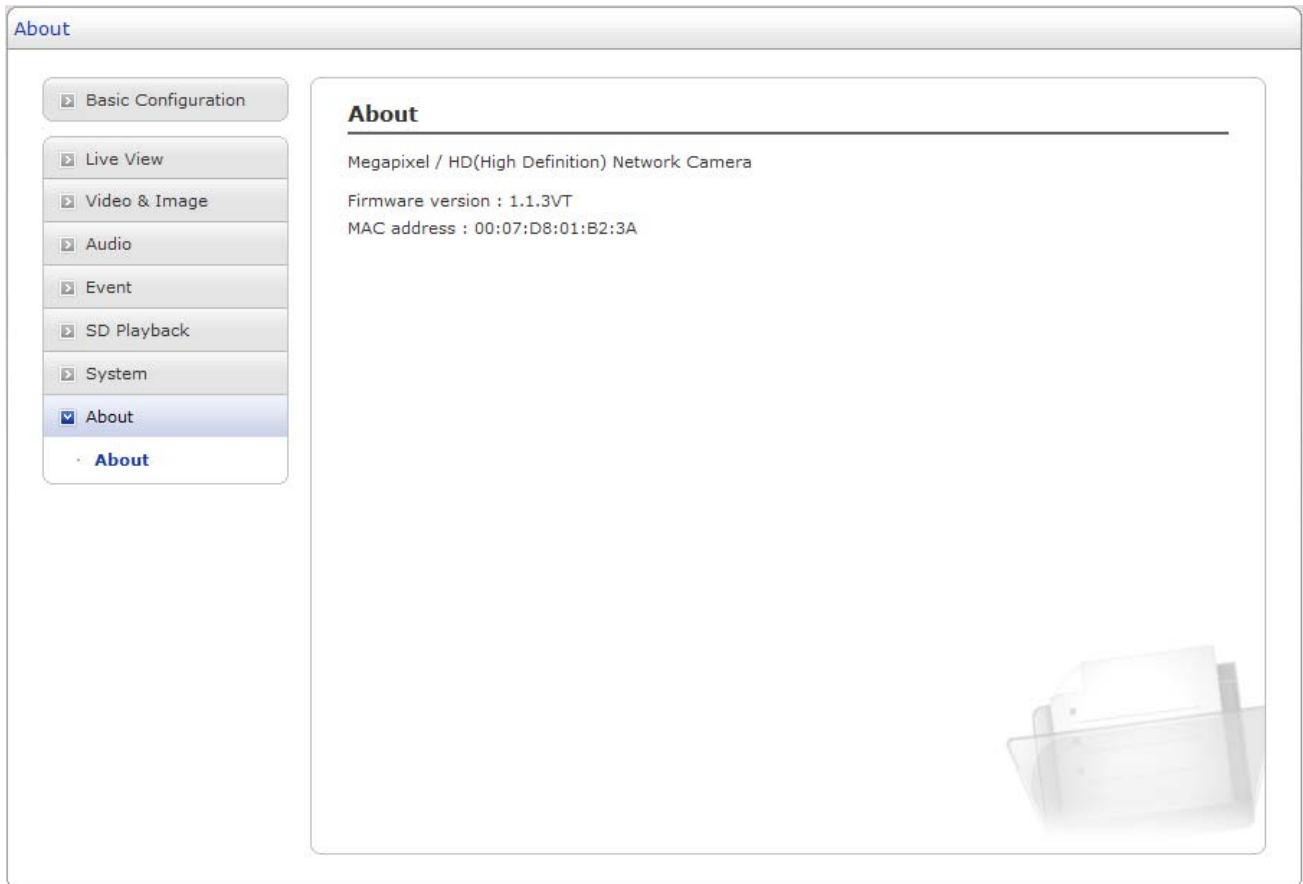

Figure 58. About

The About page shows basic information about this camera as follows:

- Megapixel / High Definition (HD) Network Camera
- Firmware version:
- MAC address:

Technical Specifications

Models

- NXD-1401M ----- NXD Series, 1 Megapixel, 30ips@1280x720
- NXD-1402M ----- NXD Series, 2 Megapixel, 15ips@1600x1200
- NXD-1301M ----- NXD Series, 1 Megapixel, 30ips@1280x720, Day/Night
- NXD-1302M ----- NXD Series, 2 Megapixel, 15ips@1600x1200, Day/Night

General

- Imaging Device ----- 1/3.2 Inch (4:3)
- Imager Type ----- CMOS
- Imager Readout ----- Progressive Scan
- Resolution ----- Maximum 1600x1200 (Effective pixels)
- Signal to Noise Ratio ----- 42.3 dB
- Lens Type ----- Auto DC Iris, 3~9mm, F1.2
- Electric Shutter Range ----- 1/2-1/1000
- Shutter Type ----- Electronic Rolling Shutter (ERS)
- Dynamic Range ----- 71 dB
- White Balance Range ----- 4000°K - 14000 °K
- Sensitivity ----- 3.5 Lux

Electrical / Connector

- Ethernet Connector ----- RJ-45 for 100Base-Tx
- Ethernet Cabling Type ----- Cat5
- BNC Connector ----- Composite analog video output
- Power connector ----- Terminal block for DC12V or AC24V input
- Power Input ----- DC12V or AC24V or PoE (IEEE802.3af Compliant, Class2)
- Power Consumption ----- Under 4.5 W
 - PoE ----- 3.5 W
 - DC12V ----- 3.12 W
 - AC24V ----- 4.2 W
- Alarm Input ----- Terminal block for two Alarm inputs
- Alarm Output ----- Terminal block for one Alarm output
- Audio Input / Output ----- 3.5mm Microphone or 3.5mm Speaker out
- Local recording ----- Micro SD Card

Video

- Compression ----- H.264 High / Main / Baseline profile and MJPEG
- Multiple streams ----- Up to 4 simultaneously
 - Stream1: H.264
 - Stream2: MJPEG
 - Stream3: H.264
 - Stream4: H.264
- Frame Rate ----- Maximum 15fps@1600x1200p, 24fps@1280x1024p, 30fps@1152x864p, 30fps@1280x720p, 25fps@720x576p, 30fps@720x480p, 30fps@640x480p, 30fps@320x240p
- Available Resolutions and Maximum Frame Rate per Second

Stream 1 H264	Stream 2 MJPEG	Stream 3 H264	Stream 4 H264	Maximum Frame Rate
1600x1200p	320x240p	320x240p	320x240p	15
1280x1024p	640x480p	320x240p	320x240p	24
1152x864p	640x480p	640x480p	320x240p	30
1152x864p	640x480p	320x240p	320x240p	30
1280x720p	640x480p	640x480p	640x480p	30
1280x720p	640x480p	640x480p	320x240p	30
1280x720p	640x480p	320x240p	320x240p	30
720x576p	720x576p	720x576p	640x480p	30
720x576p	720x576p	720x576p	320x240p	30
720x576p	720x576p	720x480p	640x480p	30
720x576p	720x576p	720x480p	320x240p	30
720x576p	720x576p	640x480p	640x480p	30
720x576p	720x576p	640x480p	320x240p	30
720x576p	720x576p	320x240p	320x240p	30
720x480p	720x480p	720x480p	640x480p	30
720x480p	720x480p	720x480p	320x240p	30
720x480p	720x480p	640x480p	640x480p	30
720x480p	720x480p	640x480p	320x240p	30
720x480p	720x480p	320x240p	320x240p	30
640x480p	640x480p	640x480p	640x480p	30
640x480p	640x480p	640x480p	320x240p	30
640x480p	640x480p	320x240p	320x240p	30
320x240p	320x240p	320x240p	320x240p	30

- Protocols ----- TCP/IP, UDP/IP (Unicast, Multicast), UPnP, DNS, DHCP, RTP, RTSP, NTP, IPv4, HTTP, HTTPS, SSL, SMTP, FTP

- Users
 - Unicast ----- Up to 10 simultaneously
 - Multicast ----- Unlimited users H.264
- Security Access ----- Multilevel Access, Data Encryption, Password protection, IP filtering
- Feature ----- ROI, Easy Focus, Digital PTZ (10x digital zoom), VMD, Image Effect, Multiple Streaming, AE, AWB, Snapshot, Manual Trigger, Audio Mute, Audio Alert, Software Reset, and Remote Upgrade.

Audio

- Compression ----- G.711 PCM 8 kHz (μ -law or A-law)
- Streaming ----- Full duplex
- Input/Output ----- External Microphone in / External Speaker out

System Integration

- API ----- Supported Open API for software integration
- Alarm Trigger ----- External Alarm input signals, VMD
- Alarm Events
 - JPEG file upload via FTP
 - Notification via Email
 - External device activation
- Intelligent Video ----- Video Motion Detection
- Video Buffering ----- Max. Pre: 25fps, Post: 25fps
- Software Interface ----- NT-Manager, SmartManager Utility, Nautilus
- System Integration ----- Supported Open API

Environmental

- Operational Temperature ----- -10 °C ~ +50 °C
- Storage Temperature ----- -20 °C ~ +60 °C
- Storage Humidity ----- 0 % ~ 96 %

Physical

- Camera Dimension (H x Ø) ----- 120 mm x 154 mm
- Shipping Dimension (H x W x D) ----- 190 mm x 190 mm x 195 mm
- Camera Weight ----- 1000 g
- Shipping Weight ----- 1300 g
- Included accessory ----- Installation CD, Accessory kit for installation, Template sheet, Extension connector kit

NOTE

Specifications are subject to change without notice.

Troubleshooting

If you suspect a problem is being caused by incorrect configuration or some other minor problem, consult the troubleshooting guide below.

Upgrading the Firmware

Firmware is software that determines the functionality of the network camera. One of your first actions when troubleshooting a problem should be to check the current firmware. The latest version may contain a correction that fixes your particular problem. The current firmware version in your camera is displayed on the Basic Configuration or About. For the latest firmware of the camera, please contact with your product administrator.

Detailed instructions on how to perform the upgrade process are provided with each new release. See also the Maintenance/ Upgrade for more information.

General Troubleshooting

The following list covers some of the problems that may be encountered and suggests how to remedy them:

Symptom → Possible Causes or Corrective Actions

1. The camera cannot be accessed by some clients.
→ If using a proxy server, try disabling the proxy setting in your browser. Check all cabling and connectors.
2. The camera works locally, but not externally.
→ Check if there are firewall settings that need to be adjusted. Check if there are router settings that need to be configured.
3. Poor or intermittent network connection.
→ If using a network switch, check that the port on that device uses the same setting for the network connection type (speed/duplex).
4. The camera cannot be accessed via a host name.
→ Check that the host name and DNS server settings are correct.
5. Not possible to log in.

- When HTTPS is enabled, ensure that the correct protocol (HTTP or HTTPS) is used. When attempting to log in, you may need to manually type in http or https in the browser's address bar.
6. No image using Refresh and/or slow updating of images.
- If images are very complex, try limiting the number of clients accessing the camera.
7. Images only shown in black & white.
- Check the Video & Image setting.
8. Blurred images.
- Refocus the camera.
9. Poor image quality.
- Increased lighting can often improve image quality. Check that there is sufficient lighting at the monitored location. Check all image and lighting settings.
10. Rolling dark bands or flickering in image.
- Try adjusting the Exposure Control setting under AE and AWB part.
11. H.264 not displayed in the client.
- Check that the correct network interface is selected in the Video & Image/Stream.
12. Multicast H.264 not displayed in the client.
- Check with your network administrator that the multicast addresses used by the camera are valid for your network. Check that the Enable multicast checkbox are enabled in the System/Network/RTP tab. Checks with your network administrator to see if there is a firewall preventing viewing.
13. Multicast H.264 only accessible by local clients.
- Check if your router supports multicasting, or if the router settings between the client and the server need to be configured. The TTL value may need to be increased.
14. Color saturation is different in H.264 and Motion JPEG.
- Modify the settings for your graphics adapter. Please see the adapter's documentation for more information.
15. Poor audio quality.
- Too many users/clients connected to the camera may affect the sound quality adversely. Try limiting the number of clients allowed to connect.
16. Distorted audio.
- Check that the correct Audio Input source is selected. Select Microphone for a connected external microphone. Select Line for a connected line in source.

NOTE

If you cannot find the help you require, please see the User's Manual, or contact with your network administrator.



eneo® is a registered trademark of Videor E. Hartig GmbH
Exclusive distribution through specialised trade channels only.

Videor E. Hartig GmbH
Carl-Zeiss-Straße 8 · 63322 Rödermark, Germany
Tel. +49 (0) 6074 / 888-0 · Fax +49 (0) 6074 / 888-100

www.videor.com



Technical changes reserved.

© Copyright by Videor E. Hartig GmbH 04/2010