



**THE DISPLAY CHOICE  
OF PROFESSIONALS™**

**SC-Series Analog HD-over-Coax Display**

# **User Manual**

[www.agneovo.com](http://www.agneovo.com)

# TABLE OF CONTENTS

## Contents

FCC Disclaimers .....	4
WEEE .....	5
Notice .....	6
Cautions When Setting Up .....	6
Cautions When Using.....	7
Cleaning and Maintenance.....	8
Notice for the LED-Backlit Display .....	8
<b>CHAPTER 1: PRODUCT DESCRIPTION.....</b>	<b>9</b>
1.1 Package Contents .....	9
1.2 Installation .....	10
1.2.1 Installing the Stand .....	10
1.2.2 Adjusting the Tilt and Rotation.....	11
1.2.3 Removing the Stand .....	12
1.2.4 Wall Mounting.....	13
1.3 LED-Backlit Display Overview.....	15
1.3.1 Front View and Control Buttons.....	15
1.3.2 Rear View .....	17
1.4 Remote Control (for SC-32AH/SC-42AH model only).....	18
1.4.1 Remote Control Buttons .....	18
1.4.2 Installing the Remote Control Batteries.....	19
<b>CHAPTER 2: MAKING CONNECTIONS.....</b>	<b>20</b>
2.1 Connecting the AC Power .....	20
2.2 Connecting a Computer .....	21
2.3 Connecting Audio Devices .....	21
2.4 Connecting Cameras and Video Devices.....	22
<b>CHAPTER 3: USING THE LED-BACKLIT DISPLAY.....</b>	<b>23</b>
3.1 Turning on the Power .....	23
3.1.1 For SC-17AH/SC-19AH/SC-22AH/SC-24AH Model.....	23
3.1.2 For SC-32AH/SC-42AH Model.....	24
3.2 Selecting the Input Source Signal .....	25
3.2.1 For SC-17AH/SC-19AH/SC-22AH/SC-24AH Model.....	25
3.2.2 For SC-32AH/SC-42AH Model.....	26
3.3 Adjusting the Volume.....	27
3.3.1 For SC-17AH/SC-19AH/SC-22AH/SC-24AH Model.....	27
3.3.2 For SC-32AH/SC-42AH Model.....	28
3.4 Locking the Control Buttons .....	28
3.5 Setting the Aspect Ratio .....	29
3.6 Using Auto Adjustment Function .....	31
<b>CHAPTER 4: ON SCREEN DISPLAY MENU.....</b>	<b>32</b>
4.1 Using the OSD Menu .....	32
4.2 OSD Menu Tree .....	34

# TABLE OF CONTENTS

<b>CHAPTER 5: ADJUSTING THE LED-BACKLIT DISPLAY.....</b>	<b>36</b>
5.1 Main Adjust.....	36
5.2 Color Adjust.....	38
5.3 Scan Settings.....	40
5.4 Image Adjust.....	41
5.5 Information.....	43
5.6 Language.....	44
5.7 Setup Menu.....	44
5.8 Recall.....	46
5.9 Exit.....	46
<b>CHAPTER 6: APPENDIX.....</b>	<b>47</b>
6.1 Warning Messages.....	47
6.2 Troubleshooting.....	48
<b>CHAPTER 7: SPECIFICATIONS.....</b>	<b>49</b>
7.1 Display Specifications.....	49
7.2 Display Dimensions.....	50

# SAFETY INFORMATION



This FCC Class-B compliant digital device complies with the Interference-Causing Equipment Regulations of Canada.

## FCC Disclaimers

This device complies with Section 15 of the FCC listing. The operation procedures must meet the following conditions: (1) the device must not cause any damaging interference; and (2) this device must accept any received interference, including any unpredictable interference that may possibly occur.

Dear users,

This device has passed the Class B digital service regulations and complies with Section 15 of the FCC listing; these are intended to provide reasonable warranty against damaging interference for home use. This device will produce, use, and emit radio frequency energy; therefore, installation or use without following the instructions given may cause damaging interference to radio communication. Nonetheless, it is not possible to state with certainty that interference will occur from specific installations. If this device has caused damaging interference to radio or TV signals (simply turn the device on and off to check if such interference is caused by the device), we recommend that you fix the interference using the following methods:

- Readjust the direction or location of the antenna.
- Increase the distance between this device and the receiver.
- Consult your local dealer or an experienced radio/TV technician.



**Warning:**

Making changes or modifications to the device without the permission from an authorized dealer may void the warranty of this device.

# SAFETY INFORMATION

## WEEE

### Information for users applicable in European Union countries

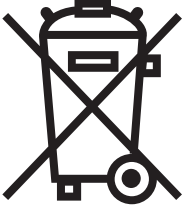

The symbol on the product or its packaging signifies that this product has to be disposed separately from ordinary household wastes at its end of life. Please kindly be aware that this is your responsibility to dispose electronic equipment at recycling centers so as to help conserve natural resources. Each country in the European Union should have its collection centers for electrical and electronic equipment recycling. For information about your recycling drop off area, please contact your local related electrical and electronic equipment waste management authority or the retailer where you bought the product.

# PRECAUTIONS

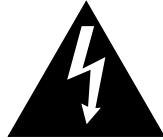

**CAUTION**  
RISK OF ELECTRIC SHOCK  
DO NOT OPEN



## Symbols used in this manual



This icon indicates the existence of a potential hazard that could result in personal injury or damage to the product.



This icon indicates important operating and servicing information.

## Notice

- Read this User Manual carefully before using the LED-backlit display and keep it for future reference.
- The product specifications and other information provided in this User Manual are for reference only. All information is subject to change without notice. Updated content can be downloaded from our web site at <http://www.agneovo.com>.
- To register online, go to <http://www.agneovo.com>.
- To protect your rights as a consumer, do not remove any stickers from the LED-backlit display. Doing so may affect the determination of the warranty period.

## Cautions When Setting Up



Do not place the LED-backlit display near heat sources, such as a heater, exhaust vent, or in direct sunlight.



Do not cover or block the ventilation holes in the housing.



Place the LED-backlit display on a stable area. Do not place the LED-backlit display where it may be subject to vibration or shock.



Place the LED-backlit display in a well-ventilated area.



Do not place the LED-backlit display outdoors.



Do not place the LED-backlit display in a dusty or humid environment.



Do not spill liquid or insert sharp objects into the LED-backlit display through the ventilation holes. Doing so may cause accidental fire, electric shock or damage the LED-backlit display.

# PRECAUTIONS

## Cautions When Using



Use only the power cord supplied with the LED-backlit display.



The power outlet should be installed near the LED-backlit display and be easily accessible.



If an extension cord is used with the LED-backlit display, ensure that the total current consumption plugged into the power outlet does not exceed the ampere rating.



Do not allow anything to rest on the power cord. Do not place the LED-backlit display where the power cord may be stepped on.



If the LED-backlit display will not be used for an indefinite period of time, unplug the power cord from the power outlet.



To disconnect the power cord, grasp and pull by the plug head. Do not tug on the cord; doing so may cause fire or electric shock.



Do not unplug or touch the power cord with wet hands.



### WARNING:

Unplug the power cord from the power outlet and refer to qualified service personnel under the following conditions:



- When the power cord is damaged.
- If the LED-backlit display has been dropped or the housing has been damaged.
- If the LED-backlit display emits smoke or a distinct odor.

# PRECAUTIONS

## Cleaning and Maintenance



Use a soft cloth to clean the glass surface and the housing.

The display can be cleaned using a cloth moistened with 95% ethyl alcohol.



Do not rub or tap the surface of the glass with sharp or abrasive items such as a pen or screwdriver. This may result in scratching the surface of the glass.



Do not attempt to service the LED-backlit display yourself, refer to qualified service personnel. Opening or removing the covers may expose you to dangerous voltage or other risks.

## Notice for the LED-Backlit Display

In order to maintain the stable luminous performance, it is recommended to use low brightness setting.

Due to the lifespan of the lamp, it is normal that the brightness quality of the LED-backlit display may decrease with time.

When static images are displayed for long periods of time, the image may cause an imprint on the LED-backlit display. This is called image retention or burn-in.

To prevent image retention, do any of the following:

- Set the LED-backlit display to turn off after a few minutes of being idle.
- Use a screen saver that has moving graphics or a blank white image.
- Switch desktop backgrounds regularly.
- Adjust the LED-backlit display to low brightness settings.
- Turn off the LED-backlit display when the system is not in use.

Things to do when the LED-backlit display shows image retention:

- Turn off the LED-backlit display for extended periods of time. It can be several hours or several days.
- Use a screen saver and run it for extended periods of time.
- Use a black and white image and run it for extended periods of time.

When the LED-backlit display is moved from one room to another or there is a sudden change from low to high ambient temperature, dew condensation may form on or inside the glass surface. When this happens, do not turn on the LED-backlit display until the dew disappears.

Due to humid weather conditions, it is normal for mist to form inside the glass surface of the LED-backlit display. The mist will disappear after a few days or as soon as the weather stabilizes.

There are millions of micro transistors inside the LED-backlit display. It is normal for a few transistors to be damaged and to produce spots. This is acceptable and is not considered a failure.



# CHAPTER 1: PRODUCT DESCRIPTION

## 1.1 Package Contents

When unpacking, check if the following items are included in the package. If any of them is missing or damaged, contact your dealer.

LED-Backlit Display

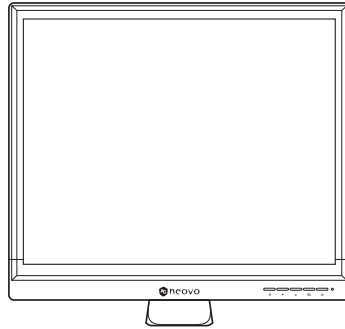

Stand

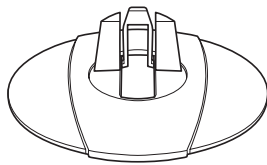

User Manual

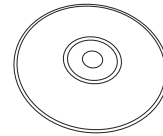

Power cord

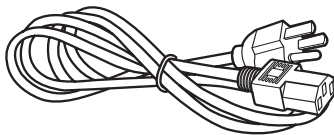

VGA cable

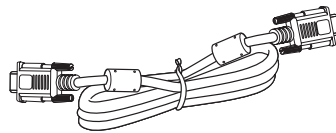

Audio cable

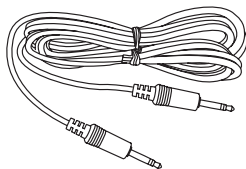

Remote control and AAA batteries\*

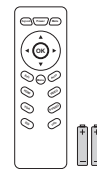

### Note:

- Use only the supplied power cord.
- The above pictures are for reference only. Actual items may vary upon shipment.
- \*Supplied only with the SC-32AH and SC-42AH model.

# PRODUCT DESCRIPTION

## 1.2 Installation

### 1.2.1 Installing the Stand

- 1 Place the LED-backlit display with the screen side down on a cushioned surface.
- 2 Do one of the following to install the stand:
  - For SC-17AH/SC-19AH and SC-22AH/SC-24AH model, align and attach the stand to the base mount until it clicks into place.

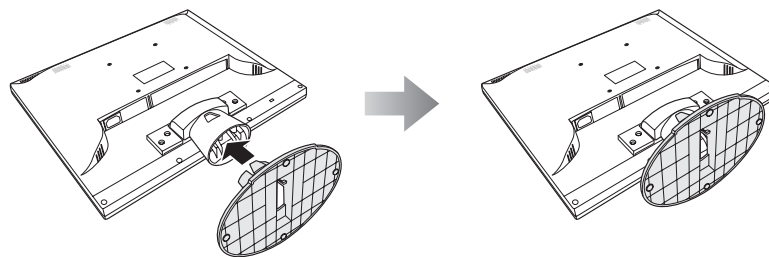

**SC-17AH/SC-19AH**

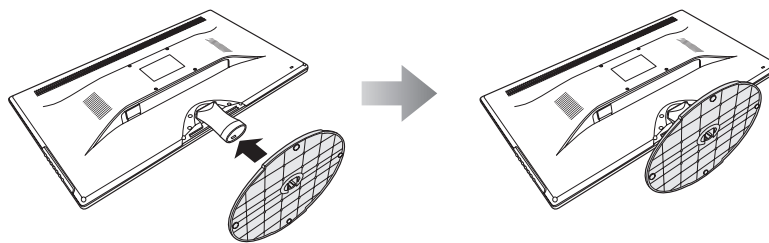

**SC-22AH/SC-24AH**

- For SC-32AH model, align and install the stand to the base mount. Then secure the stand with the screws.

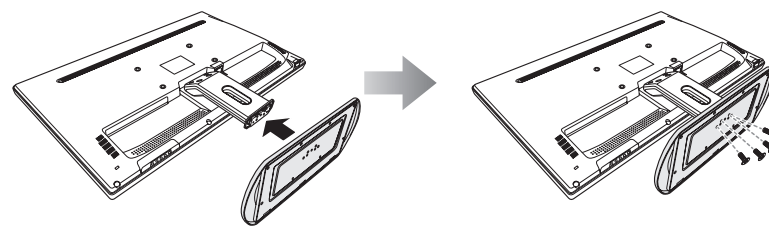

**SC-32AH**

- For SC-42AH model:
  - a) Remove the screws from the base mount compartment.
  - b) Align and install the base mount to its compartment on the LED-backlit display. Then secure the base mount with the screws.
  - c) Align and install the stand to the base mount. Then secure the stand with the screws.

# PRODUCT DESCRIPTION

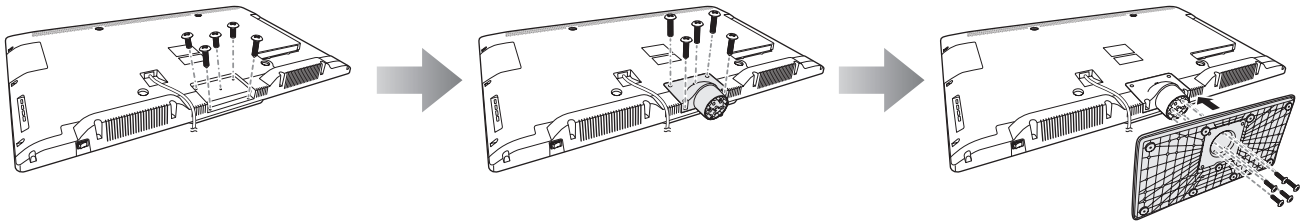

**SC-42AH**

## 1.2.2 Adjusting the Tilt and Rotation

For comfort viewing, you can tilt the LED-backlit display [for SC-17AH/SC-19AH/SC-22AH/SC-24AH/SC-32AH model] to a certain degree forwards or backwards, or rotate the LED-backlit display [for SC-42AH model] around its axis. Hold the stand with one hand and use the other hand to adjust the LED-backlit display to the desired angle supported by your display model as described below.

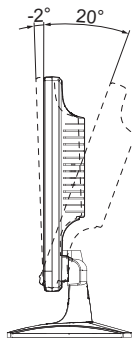

**SC-17AH (-2°~20°)**

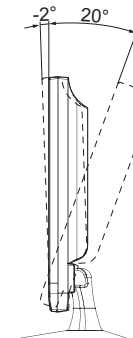

**SC-19AH (-2°~20°)**

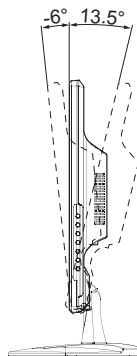

**SC-22AH (-6°~13.5°)**

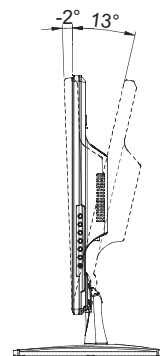

**SC-24AH (-2°~13°)**

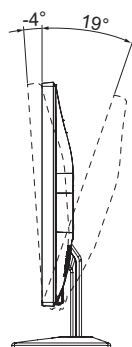

**SC-32AH (-4°~19°)**

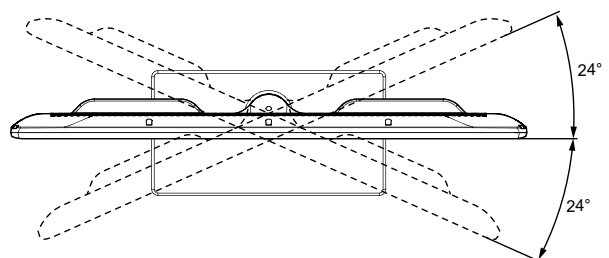

**SC-42AH (24° to the left or to the right)**

# PRODUCT DESCRIPTION

## 1.2.3 Removing the Stand

- 1 Place the LED-backlit display with the screen side down on a cushioned surface.
- 2 Do one of the following to remove the stand:
  - For SC-17AH/SC-19AH model, press the release tab downwards and detach the stand from the base mount.

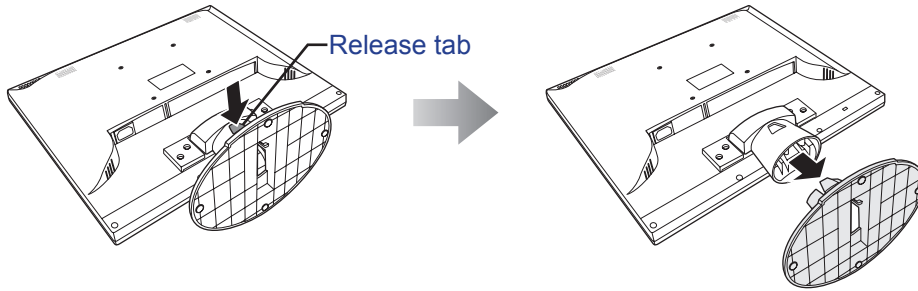

**SC-17AH/SC-19AH**

- For SC-22AH/SC-24AH model, pull the release lever and detach the stand from the base mount.

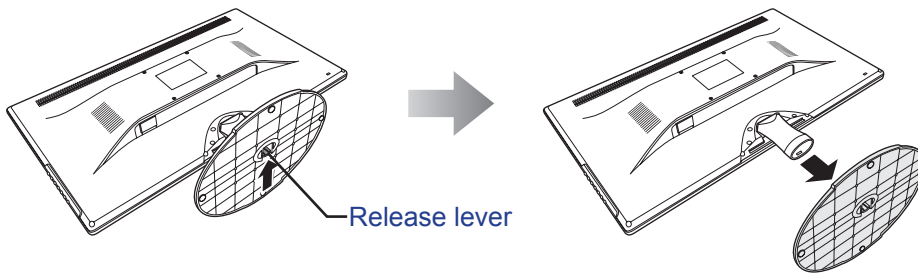

**SC-22AH/SC-24AH**

- For SC-32AH/SC-42AH model, remove the screws from the stand, and then remove the stand.

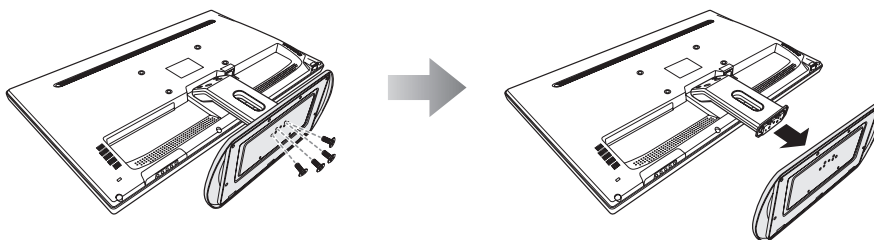

**SC-32AH**

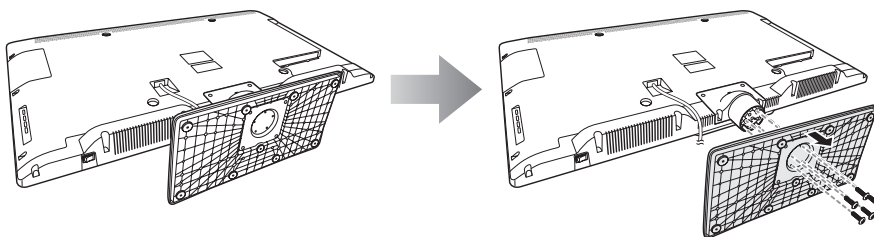

**SC-42AH**

# PRODUCT DESCRIPTION

## 1.2.4 Wall Mounting

To wall mount the LED-backlit display, do the following steps:

- 1 Remove the base stand. Refer to “1.2.3 Removing the Stand”.
- 2 Place the LED-backlit display with the screen side down on a cushioned surface.
- 3 Remove the base mount.
  - a. Remove the screws securing the base mount to the LED-backlit display.
  - b. Detach the base mount from its compartment.

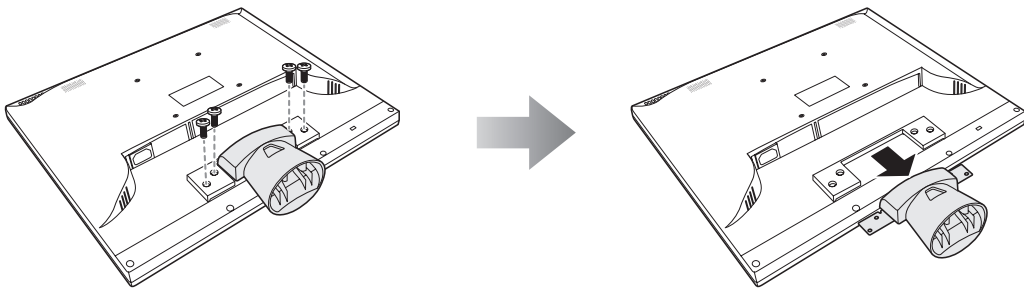

*SC-17AH/SC-19AH*

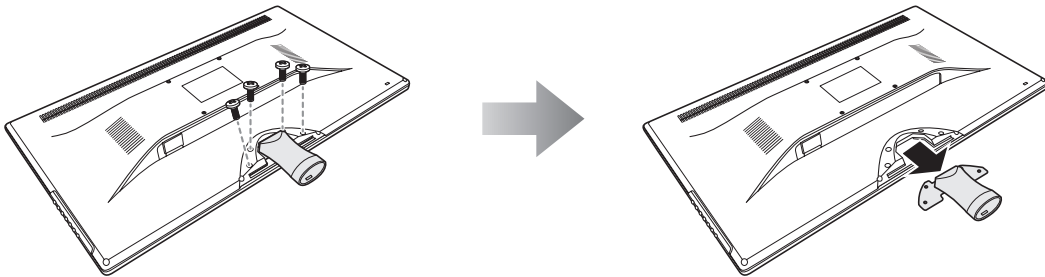

*SC-22AH/SC-24AH*

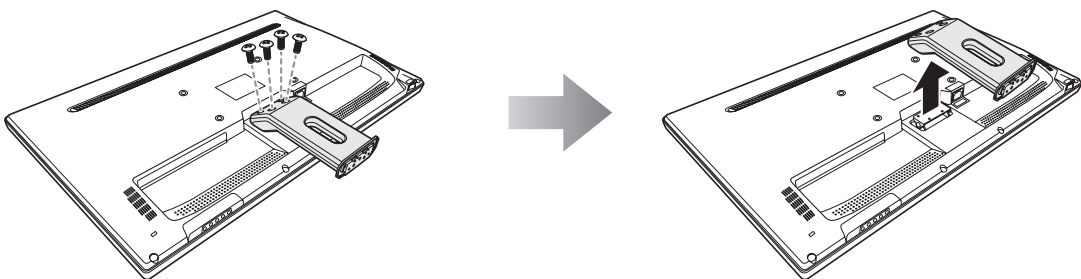

*SC-32AH*

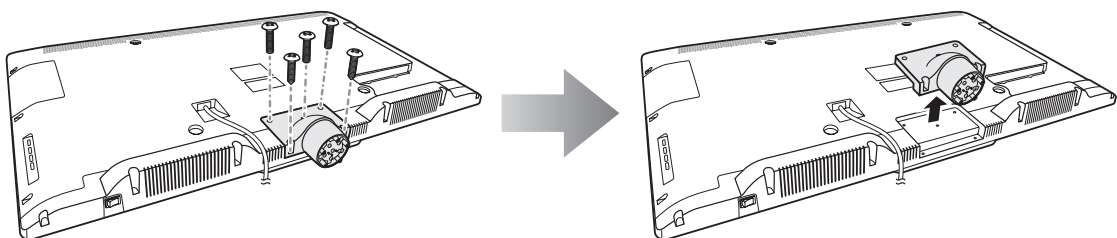

*SC-42AH*

# PRODUCT DESCRIPTION

## 3 Wall mount the LED-backlit display.

Screw the mounting bracket to the VESA holes at the rear of the LED-backlit display.

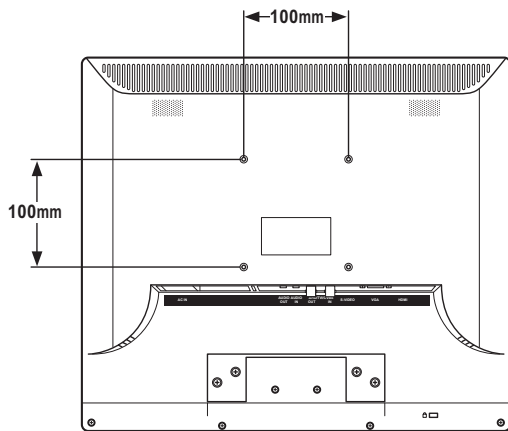

**SC-17AH/SC-19AH**

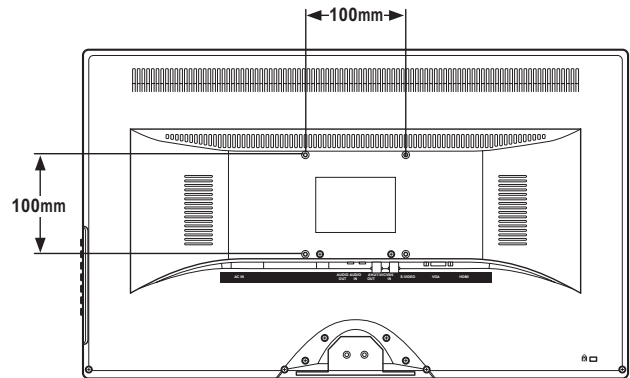

**SC-22AH/SC-24AH**

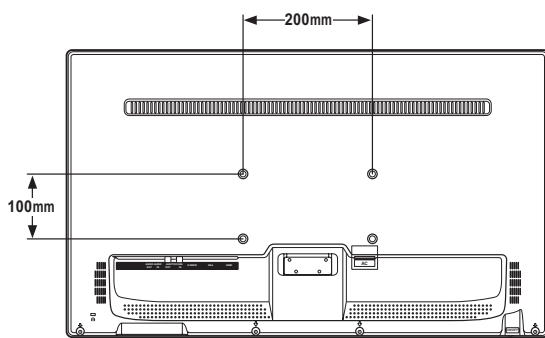

**SC-32AH**

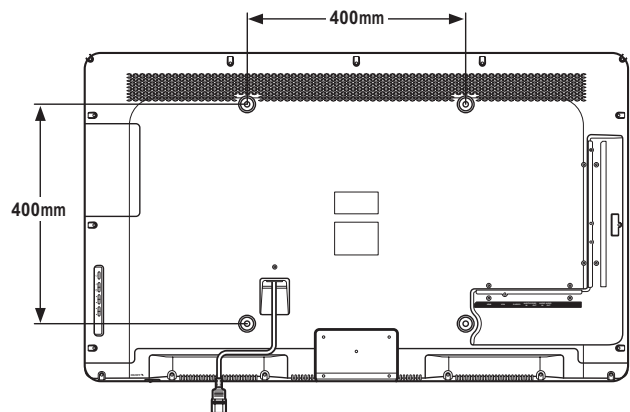

**SC-42AH**

**Note:** Take measures to prevent the LED-backlit display from falling down and lessen possible injury and damage to the display in case of earthquakes or other disasters.

- Use only the 100 x 100 mm wall mount kit recommended by AG Neovo. All AG Neovo wall mount kits comply with VESA standard.
- Secure the LED-backlit display on a solid wall strong enough to bear its weight.
- It is suggested to wall mount the LED-backlit display without tilting it facing downward.

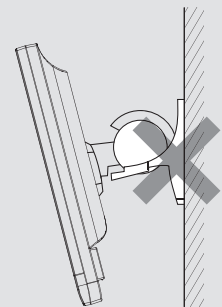

# PRODUCT DESCRIPTION

## 1.3 LED-Backlit Display Overview

### 1.3.1 Front View and Control Buttons

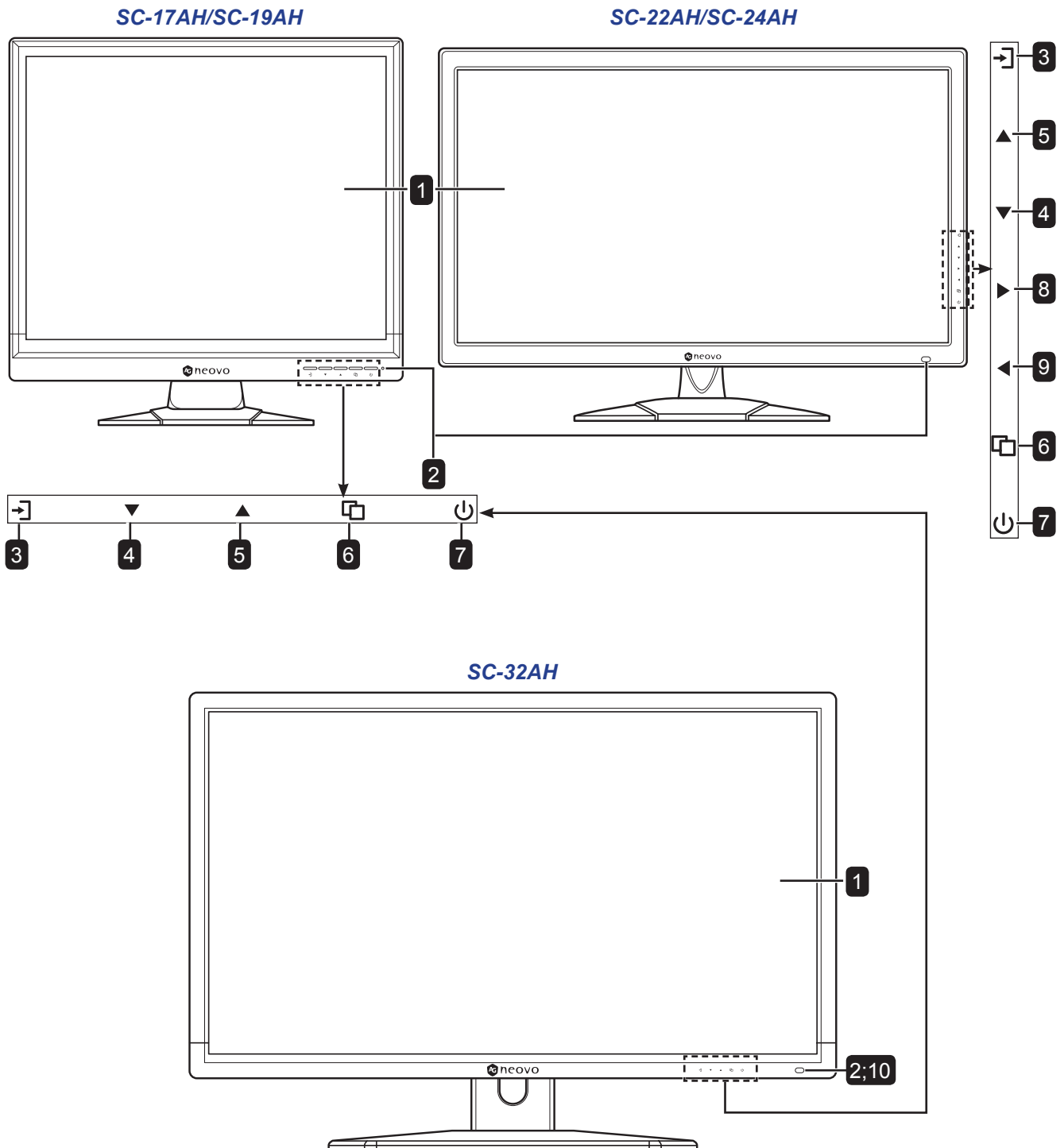

# PRODUCT DESCRIPTION

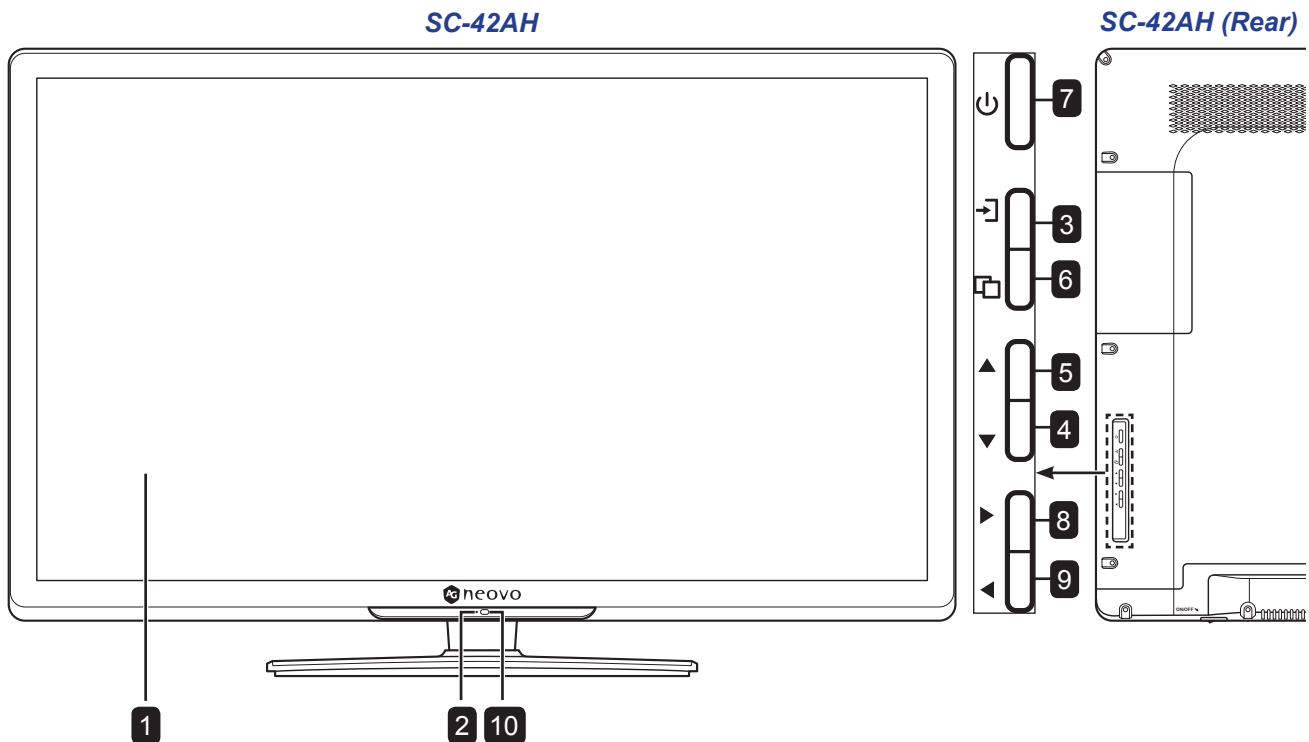

## 1 Display screen

The LED-backlit display screen.

## 2 Power LED indicator

- Green - Power on
- OFF - Power off

## 3 Source →]

Press to select the input signal source.

## 4 Down ▼

- During OSD menu selection, press to move down a menu or submenu.

**Note:** For SC-17AH/SC-19AH/SC-32AH model, press to adjust the parameter value.

- For SC-17AH/SC-19AH/SC-32AH model, press to call out Volume Bar. Then press again to decrease the volume.
- During source selection, press to select the input source.

## 5 Up ▲

- During the OSD menu selection, press to move up a menu or submenu.

**Note:** For SC-17AH/SC-19AH/SC-32AH model, press to adjust the parameter value.

- For SC-17AH/SC-19AH/SC-32AH model, press to call out Volume Bar. Then press again to increase the volume.
- During source selection, press to select the input source.

## 6 Menu □

- Press to display the OSD menu.
- During volume adjustment, press to exit the Volume Bar.
- During source selection, press to exit the source menu.

## 7 Power ⏻

Press to turn the power on or off.

## 8 Right ► [for SC-22AH/SC-24AH/SC-42AH model only]

- During OSD menu selection, press to adjust the parameter value.
- Press to call out Volume Bar. Then press again to increase the volume.

## 9 Left ◀ [for SC-22AH/SC-24AH/SC-42AH model only]

- During OSD menu selection, press to adjust the parameter value.
- Press to call out Volume Bar. Then press again to decrease the volume.

## 10 Remote control sensor

Receive command signals from the remote control.



# PRODUCT DESCRIPTION

## 1.3.2 Rear View

SC-17AH/SC-19AH

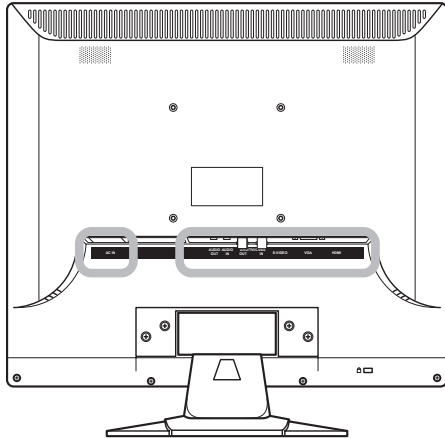

SC-22AH/SC-24AH

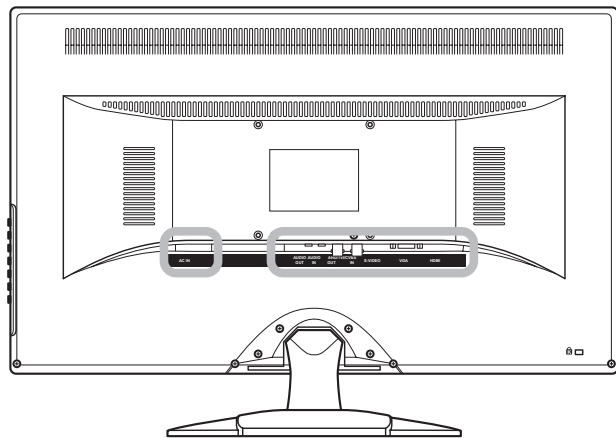

SC-42AH

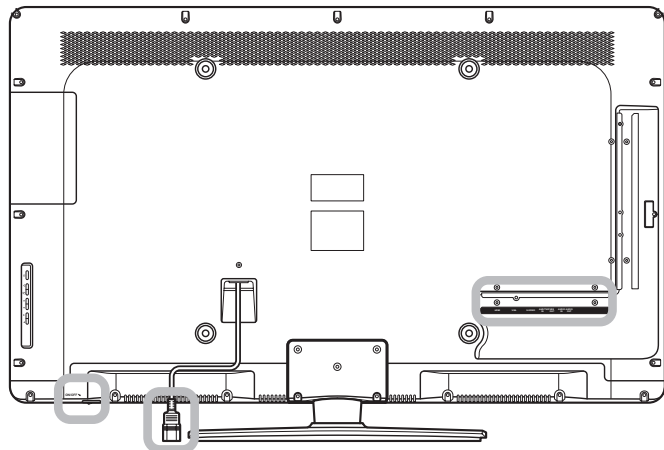

SC-32AH

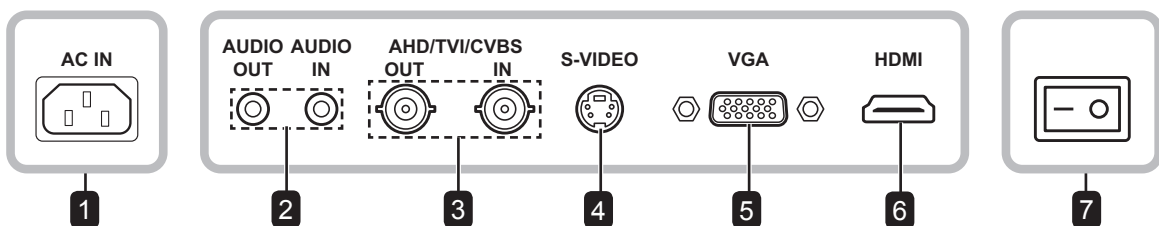
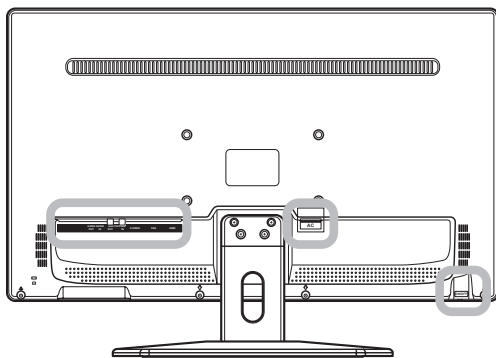

**1 AC IN connector**

Use to connect the power cord.

**2 AUDIO OUT / AUDIO IN connectors (2)**

Use to connect an audio signal.

**3 AHD/TVI/CVBS OUT connectors (2)**

Use to connect composite cables for CVBS input/output signal.

**4 S-Video connector**

Use to connect an AV cable for S-Video signal.

**5 VGA connector**

Use to connect a computer using a VGA cable for an analogue input signal.

**6 HDMI connector**

Use to connect an input device using an HDMI cable for digital input signal.

**7 Main Power switch (for SC-32AH/SC-42AH model only)**

Switch the main power on/off.

# PRODUCT DESCRIPTION

## 1.4 Remote Control (for SC-32AH/SC-42AH model only)

### 1.4.1 Remote Control Buttons

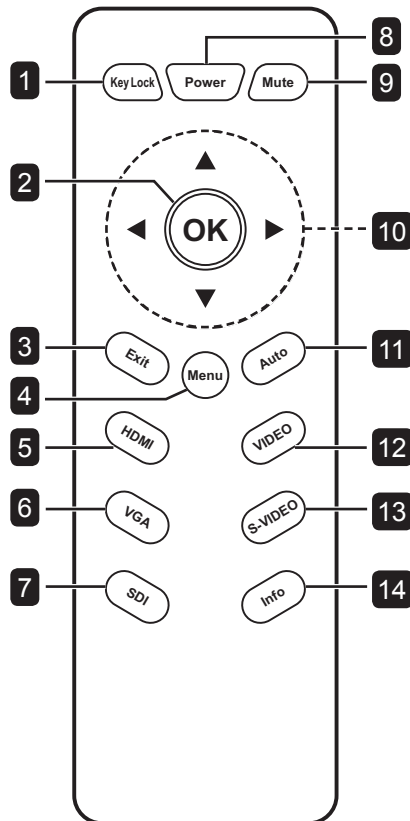

#### 1 Key Lock button

Press to lock or unlock buttons on the control panel or on the remote control.

#### 2 OK button

- Press to display the OSD menu.
- Press to confirm an entry or selection.

#### 3 Exit button

Press (repeatedly if necessary) to close the OSD menu and its submenus.

#### 4 Menu button

- Press to display or hide the OSD menu.
- Press to enter or exit a submenu item.

#### 5 HDMI button

Press to select HDMI as the input signal.

#### 6 VGA button

Press to select VGA as the input signal.

#### 7 SDI button

No function.

#### 8 Power button

Press to turn the LED-backlit display on or off.

#### 9 Mute button

Press to mute volume.

#### 10 Navigation buttons

Press to navigate through the OSD menu and adjust the settings.

#### 11 Auto button

Press to automatically adjust the image in VGA mode.

#### 12 Video button

Press to select Video as input signal.

#### 13 S-Video button

Press to select S-Video as the input signal.

#### 14 Info button

Press to display the currently selected LED-backlit display input signal.

# PRODUCT DESCRIPTION

## 1.4.2 Installing the Remote Control Batteries

Two AAA-type batteries are supplied for the remote control. To install or replace the batteries, do the following:

- 1 Remove the battery cover on the rear of the remote control.
- 2 Insert two AAA batteries with the correct polarity (+/-) as shown inside the battery compartment.
- 3 Replace the battery cover.

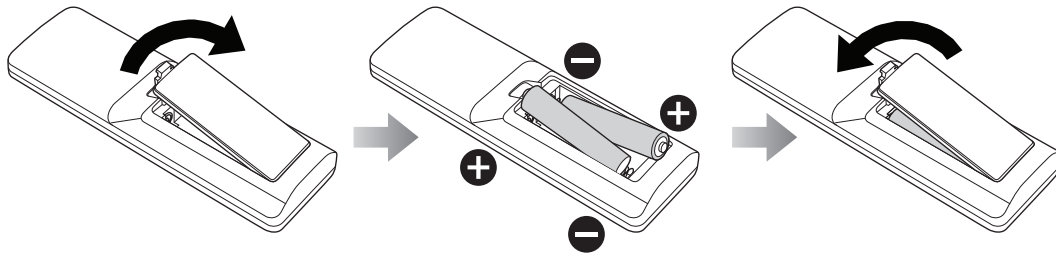

### IMPORTANT!

- Avoid storing the remote control in a humid and hot environment.
- Do not place the remote control in direct sunlight.
- Do not attempt to charge, short-circuit, heat, or burn the batteries.
- If the remote control is not in use for an extended period of time, remove the batteries to prevent any damage due to battery leakage.
- Do not mix old and new batteries or batteries of different types. Use only AAA-type batteries.
- Always follow local regulations for battery disposal.

# CHAPTER 2: MAKING CONNECTIONS



**CAUTION:**

Make sure that the LED-backlit display is not connected to the power outlet before making any connections. Connecting cables while the power is ON may cause possible electric shock or personal injury.

## 2.1 Connecting the AC Power

- 1 Connect the power cord to the AC power input at the rear of the LED-backlit display.
- 2 Connect the plug to a power outlet or power supply.

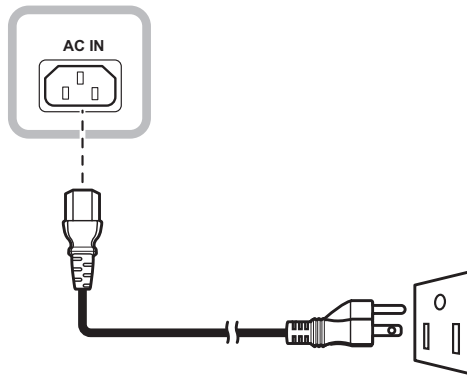

**CAUTION:**

When unplugging the power cord, hold the power cord by the plug head. Never pull by the cord.

# MAKING CONNECTIONS

## 2.2 Connecting a Computer

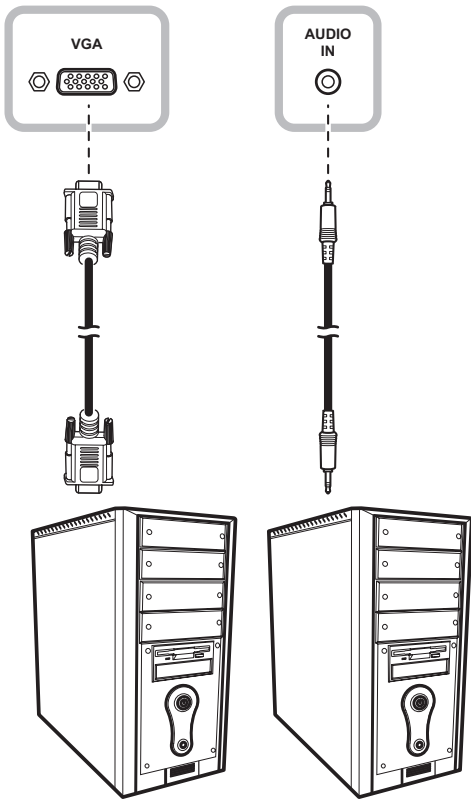

- **VGA**

Connect one end of a D-sub 15-pin cable to the VGA connector of the LED-backlit display and the other end to the D-sub connector of the computer.

- **Audio**

Connect one end of an audio cable to the audio in connector of the LED-backlit display and the other end to the audio out connector of the computer.

## 2.3 Connecting Audio Devices

- 1 Connect one end of an audio cable to the audio out connector on the LED-backlit display.
- 2 Connect the other end of an audio connector to the RCA connector of your audio device.

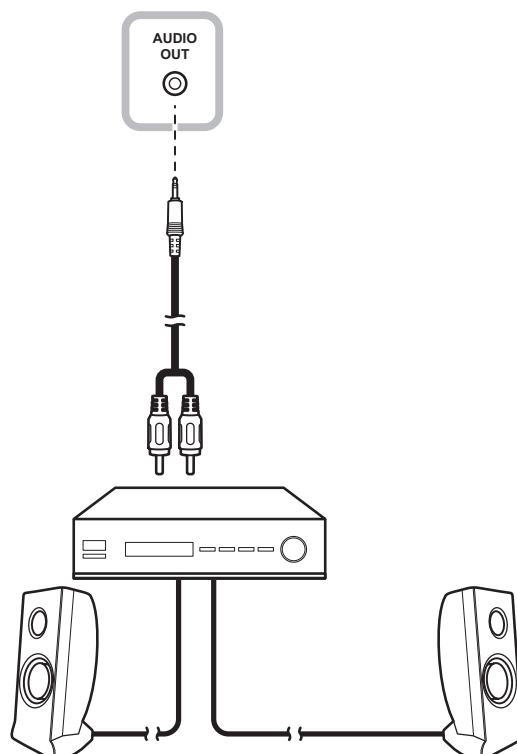

# MAKING CONNECTIONS

## 2.4 Connecting Cameras and Video Devices

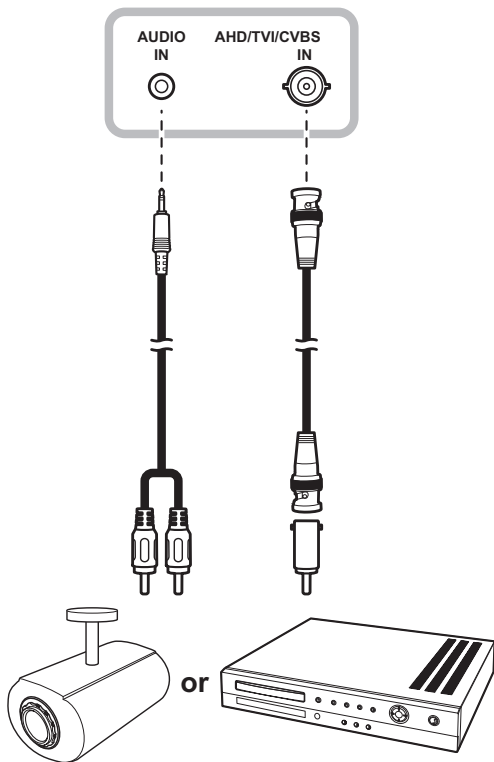

- **CVBS**

Connect one end of a composite cable to the AHD/TVI/CVBS in connector of the LED-backlit display and the other end to the composite connector of your camera or video device.

- **Audio**

Connect one end of a RCA cable to the audio in connector of the LED-backlit display and the other end to the RCA connector of your camera or video device.

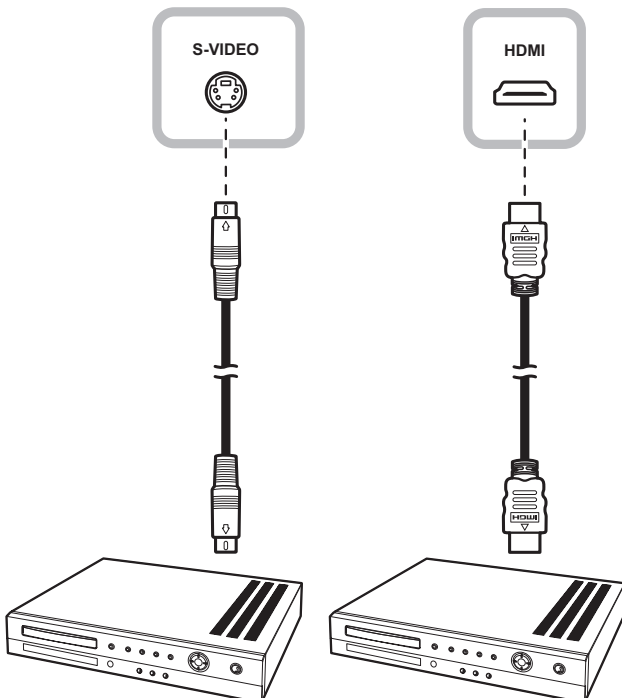

- **S-Video**

Connect one end of an AV cable to the S-video connector of the LED-backlit display and the other end to the S-video connector of your video device.

- **HDMI**

Connect one end of an HDMI cable to the HDMI connector of the LED-backlit display and the other end to the HDMI connector of your video device.

# CHAPTER 3: USING THE LED-BACKLIT DISPLAY

## 3.1 Turning on the Power

### 3.1.1 For SC-17AH/SC-19AH/SC-22AH/SC-24AH Model

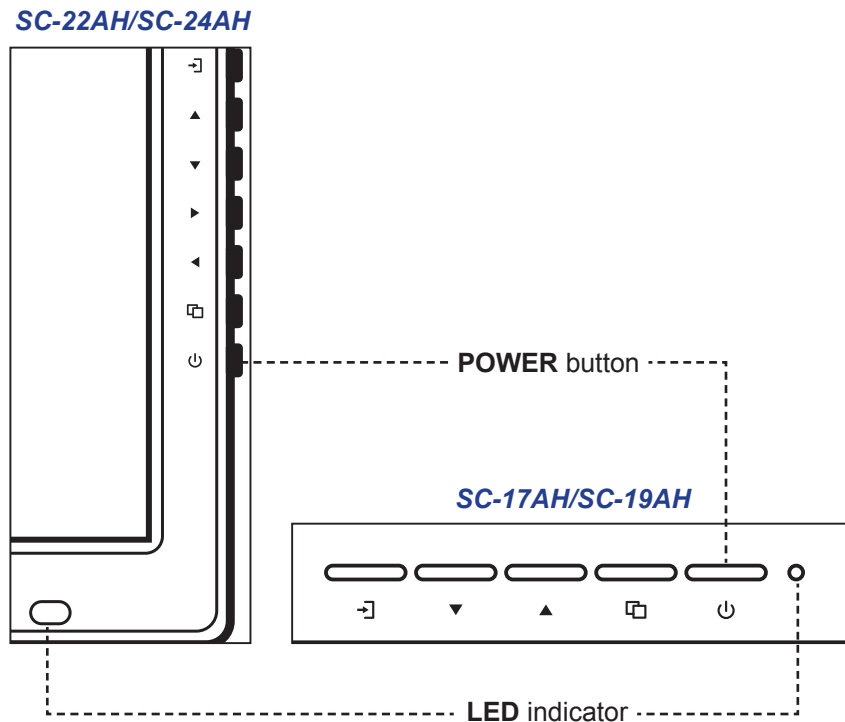

- 1 Connect the power cord to the AC power input at the rear of the LED-backlit display.
- 2 Connect the plug to a power outlet or power supply.
- 3 Press the  button to turn the LED-backlit display on.

The LED indicator turns GREEN.

When the LED-backlit display is turned on, press the  button to turn off the LED-backlit display. The LED indicator turns off.

**Note:** *The LED-backlit display still consumes power as long as the power cord is connected to the power outlet. Disconnect the power cord to completely cut off power.*

# USING THE LED-BACKLIT DISPLAY

## 3.1.2 For SC-32AH/SC-42AH Model

- 1 Connect the power cord to the AC power input at the rear of the LED-backlit display.
- 2 Connect the plug to a power outlet or power supply.
- 3 Set the **Main Power** switch to ON.  
The LED indicator turns GREEN.

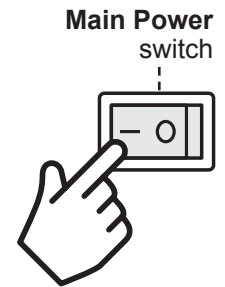

**Note:** When the LED-backlit display is switched on, set the **Main Power** switch to OFF to switch off the LED-backlit display. The LED indicator turns off.

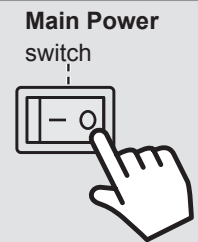

- 4 Press the **⏻** button on the control panel or the **Power** button on the remote control to turn the LED-backlit display on.

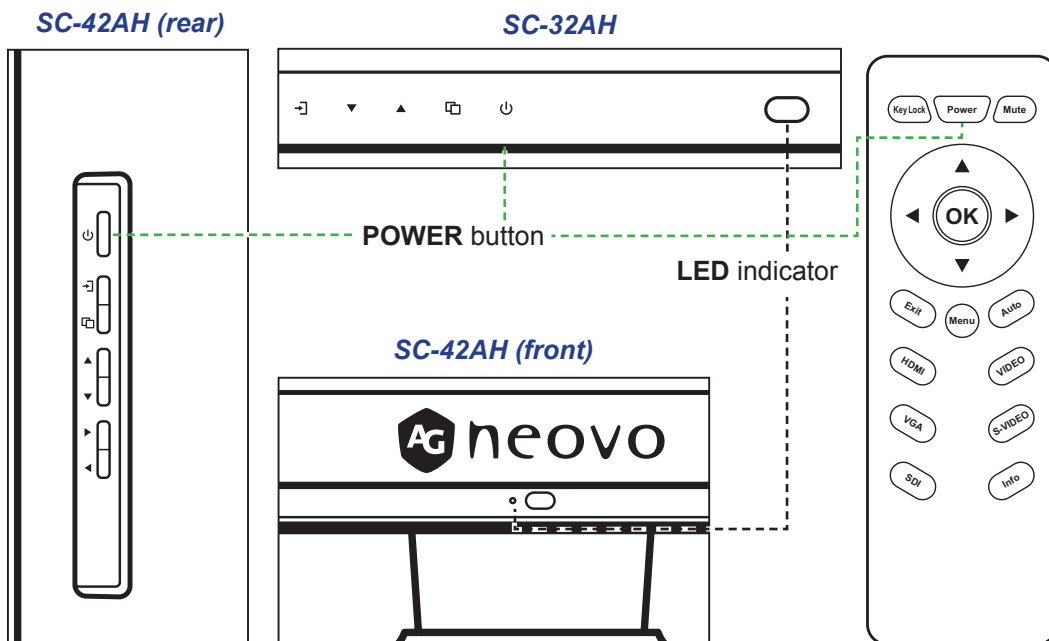

The LED indicator turns GREEN.

When the LED-backlit display is turned on, press the **⏻** button on the control panel or the **Power** button on the remote control to turn the LED-backlit display off. The LED indicator turns off.



# USING THE LED-BACKLIT DISPLAY



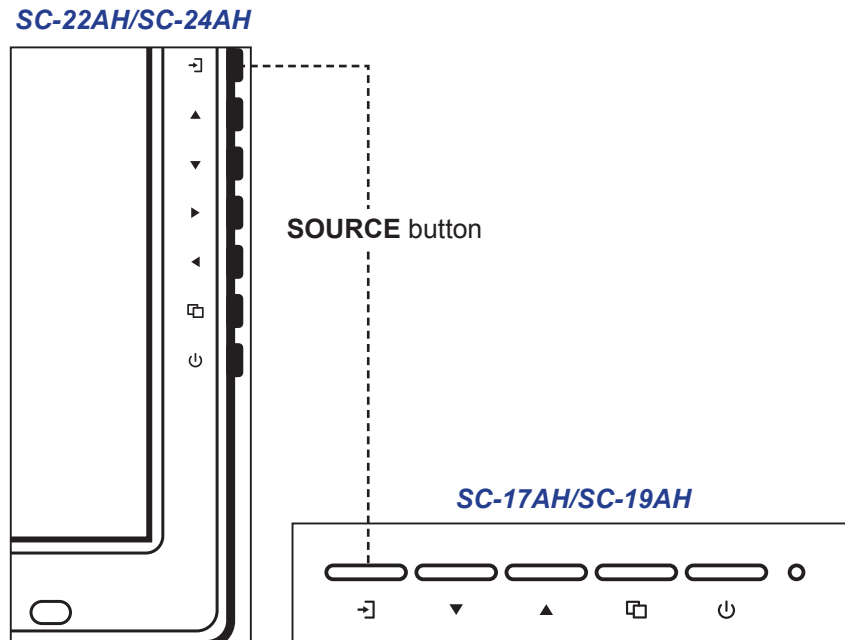

## 3.2 Selecting the Input Source Signal

### 3.2.1 For SC-17AH/SC-19AH/SC-22AH/SC-24AH Model



- 1 Press the  button to call out the input source menu.



- 2 Press the  or  button or press the  button repeatedly to highlight an input source.
- 3 Press the  button to select the input source.

#### Note:

- After selecting an input source signal, the input source signal message appears on the screen briefly.

CVBS  
MAIN: NTSC

VGA  
MAIN: 640x480

S-VIDEO  
MAIN: NTSC

HDMI  
MAIN: 1280x720

- If the selected input source signal is not connected to the LED-backlit display or is turned off, the no signal message is displayed on the screen.

INFORMATION

NO SIGNAL

# USING THE LED-BACKLIT DISPLAY

## 3.2.2 For SC-32AH/SC-42AH Model

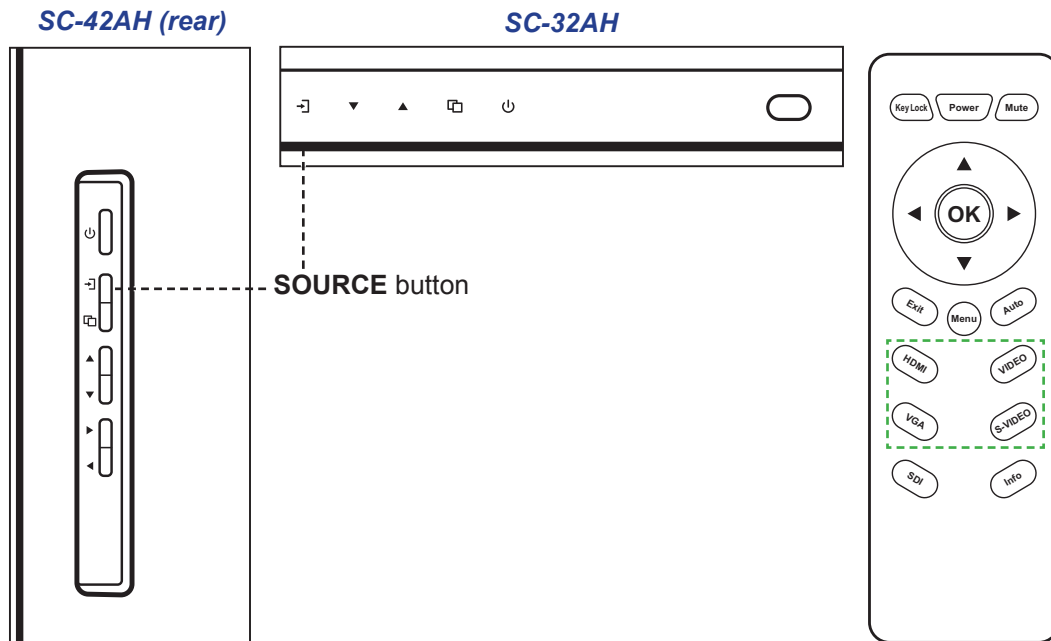

1 Do any of the following:

- Press the desired source button (**HDMI**, **VGA**, **VIDEO**, or **S-VIDEO**) directly on the remote control.
- Press the **SOURCE** button on the control panel to call out the input source menu and follow steps 2 to 3.



- 2 Press the **▲** or **▼** button or press the **SOURCE** button repeatedly to highlight an input source.
- 3 Press the **ENTER** button to select the input source.

**Note:**

- After selecting an input source signal, the input source signal message appears on the screen briefly.

CVBS  
MAIN: NTSC

VGA  
MAIN: 640x480

S-VIDEO  
MAIN: NTSC

HDMI  
MAIN: 1280x720

- If the selected input source signal is not connected to the LED-backlit display or is turned off, the no signal message is displayed on the screen.

INFORMATION

NO SIGNAL

# USING THE LED-BACKLIT DISPLAY

## 3.3 Adjusting the Volume

### 3.3.1 For SC-17AH/SC-19AH/SC-22AH/SC-24AH Model

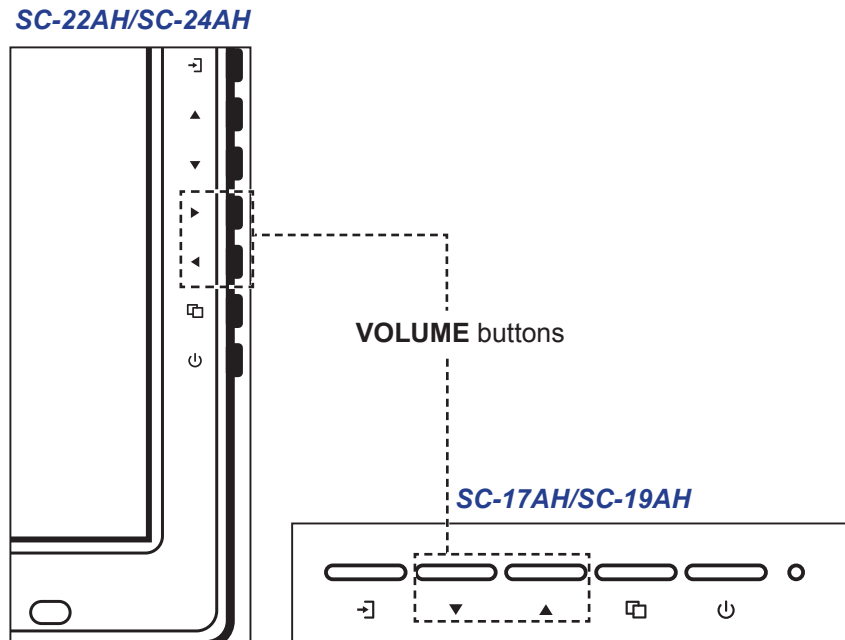

- 1 Press the ▲ or ▼ button [for SC-17AH/SC-19AH model] or the ◀ or ▶ button [for SC-22AH/SC-24AH model] to call out the Volume Bar.



- 2 Press the ▲ or ▼ button [for SC-17AH/SC-19AH model] or the ◀ or ▶ button [for SC-22AH/SC-24AH model] to adjust the volume level.
- 3 Press the □ button to close the Volume Bar.

**Note:** Volume can be also adjusted using the OSD menu. Please refer to page 36.

# USING THE LED-BACKLIT DISPLAY

## 3.3.2 For SC-32AH/SC-42AH Model

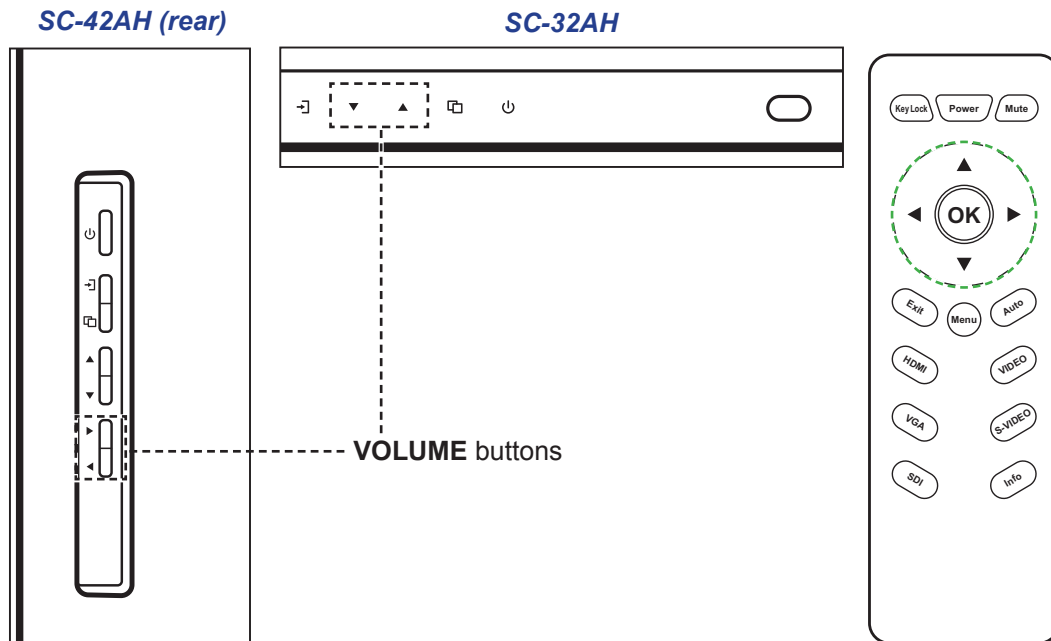

- 1 Press the ▲ or ▼ button [for SC-32AH model] or the ◀ or ▶ button [for SC-42AH model] on the control panel or the remote control to call out the volume bar.



- 2 Press the ▲ or ▼ button [for SC-32AH model] or the ◀ or ▶ button [for SC-42AH model] on the control panel or the remote control to adjust the volume level.
- 3 Press the □ button on the control panel or the OK button/Menu button on the remote control to close the Volume Bar.

**Note:** Volume can be also adjusted using the OSD menu. Please refer to page 36.

## 3.4 Locking the Control Buttons

**Note:** The remote control function is supported only for SC-32AH and SC-42AH model.

Lock the control buttons to protect the LED-backlit display from unauthorised users or from accidentally pressing the button.

To lock the control buttons, press and hold the □ button on the control panel or press the **Key Lock** button on the remote control until you see the following message appears on the upper left corner of the screen:

☒ KEY LOCK



To unlock the control buttons, press and hold the □ button on the control panel or press the **Key Lock** button on the remote control until you see the following message appears on the upper left corner of the screen:

☒ KEY UN-LOCK

# USING THE LED-BACKLIT DISPLAY

## 3.5 Setting the Aspect Ratio

**Note:** The remote control function is supported only for SC-32AH and SC-42AH model.

- 1 Press the  button on the control panel or the **Menu** button/**OK** button on the remote control to call out the OSD window.
- 2 Press the **▲** or **▼** button on the control panel or the remote control to select the **SCAN SETTING** and press the  button on the control panel or the **OK** button/**Menu** button on the remote control to enter the **SCAN SETTING** menu.
- 3 Press the **▲** or **▼** button on the control panel or the remote control to select **SCAN SETTING** and press the  button on the control panel or the **OK** button/**Menu** button on the remote control.
- 4 Press the **▲** or **▼** button [for SC-17AH/SC-19AH/SC-32AH model] on the control panel or the remote control or the **◀** or **▶** button [for SC-22AH/SC-24AH/SC-42AH model] on the control panel or the remote control to select the aspect ratio among the following options:

- **Underscan** - The picture is displayed in full screen.

**SC-17AH/SC-19AH**

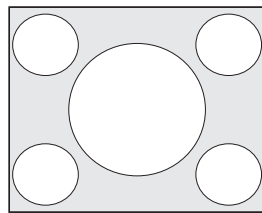

**SC-22AH/SC-24AH/SC-32AH/SC-42AH**

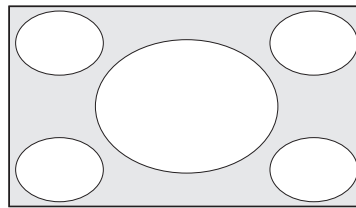

- **Overscan** - The picture is displayed in full screen while retaining the original aspect ratio. This results in a zoomed image and some part of the picture may appear cut-off.

**SC-17AH/SC-19AH**

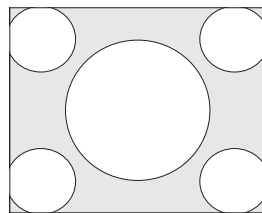

**SC-22AH/SC-24AH/SC-32AH/SC-42AH**

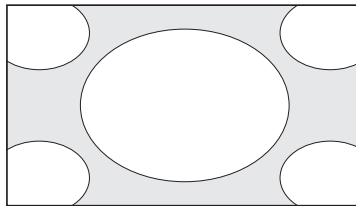

- **Normal** [for SC-17AH/SC-19AH model in AHD/TVI mode] - The picture is displayed in full screen with the aspect ratio 4:3 and a black band is displayed at the top and bottom.

**SC-17AH/SC-19AH  
(AHD/ TVI mode)**

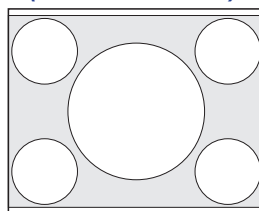

# USING THE LED-BACKLIT DISPLAY

- **Letterbox** [for SC-17AH/SC-19AH model in AHD/TVI mode] - The picture is enlarged to 21:9 format and a black band is displayed at the top and bottom.

**SC-17AH/SC-19AH**  
**(AHD/ TVI mode)**

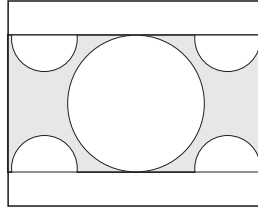

- **4:3** [for SC-22AH/SC-24AH/SC-32AH/SC-42AH model] - The picture is displayed in full screen with the aspect ratio 4:3.

**SC-22AH/SC-24AH/SC-**  
**32AH/SC-42AH**

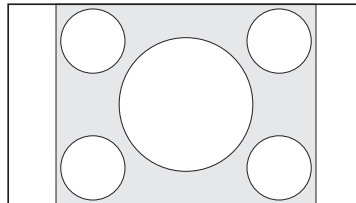







# USING THE LED-BACKLIT DISPLAY

## 3.6 Using Auto Adjustment Function

Auto adjustment function automatically tunes the LED-backlit display to its optimal setting, including horizontal position, vertical position, clock, and phase.

**Note:**

- Auto adjustment function is available with the VGA input source only.
- *The remote control function is supported only for SC-32AH and SC-42AH model.*

- 1 Press the  button on the control panel or the **Menu** button/**OK** button on the remote control to call out the OSD window.
- 2 Press the  or  button on the control panel or the remote control to select the **IMAGE ADJUST** menu.
- 3 Press the  button on the control panel or the **OK** button/**Menu** button on the remote control to enter the **IMAGE ADJUST** menu.
- 4 Press the  or  button on the control panel or the remote control to select **AUTO ADJUST** and press the  button on the control panel or the **OK** button/**Menu** button on the remote control.

The message auto adjusting is displayed on the screen.

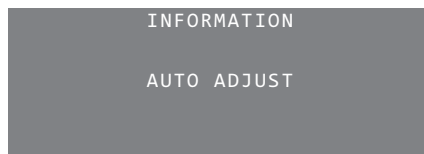

When the message disappears, auto adjustment is completed.







**Note:**

- *During auto adjustment, the screen will slightly shake for a few seconds.*
- *It is recommended to use the auto adjustment function when using the LED-backlit display for the first time or after a resolution or frequency change.*

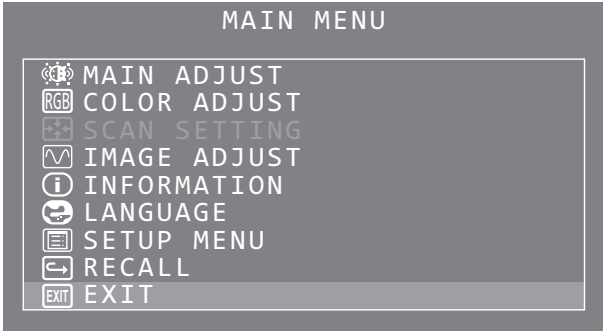
# CHAPTER 4: ON SCREEN DISPLAY MENU

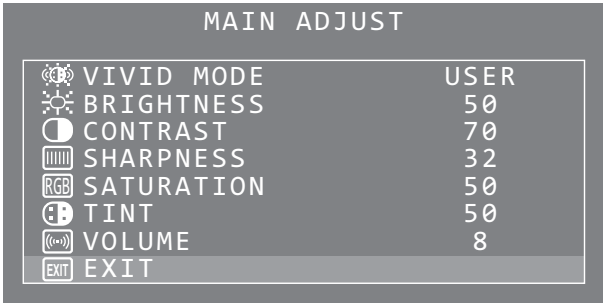

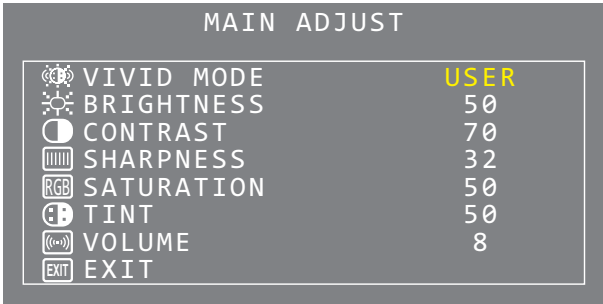

## 4.1 Using the OSD Menu

**Note:** The remote control function is supported only for SC-32AH and SC-42AH model.

#	Menu Navigation	Operation	
		Control Panel	Remote Control
1	Display the <b>MAIN MENU</b> screen. 	Press the  button.	Press the <b>Menu</b> button/ <b>OK</b> button.
2	Select the submenu.  The highlighted item indicates the active submenu.	1 Press the <b>▲</b> or <b>▼</b> button to select the menu item. 2 Press the  button to enter the submenu.	1 Press the <b>▲</b> or <b>▼</b> button to select the menu item. 2 Press the <b>Menu</b> button/ <b>OK</b> button to enter the submenu.
3	Select the submenu item.  The highlighted item (yellow) indicates the active submenu.	1 Press the <b>▲</b> or <b>▼</b> button to select the submenu item. 2 Press the  button to enter the settings.	1 Press the <b>▲</b> or <b>▼</b> button to select the submenu item. 2 Press the <b>Menu</b> button/ <b>OK</b> button to enter the submenu.
4	Adjust the settings.	Press the <b>▲</b> or <b>▼</b> button [for SC-17AH/ SC-19AH/SC-32AH model] or press the <b>◀</b> or <b>▶</b> button [for SC-22AH/SC-24AH/ SC-42AH model].	Press the <b>▲</b> or <b>▼</b> button [for SC-17AH/ SC-19AH/SC-32AH model] or press the <b>◀</b> or <b>▶</b> button [for SC-22AH/SC-24AH/ SC-42AH model].



# ON SCREEN DISPLAY MENU

#	Menu Navigation	Operation	
		Control Panel	Remote Control
<b>5</b>	Exit the submenu.	<ol style="list-style-type: none"> <li><b>1</b> Press the  button.</li> <li><b>2</b> Press the  button to select <b>EXIT</b>.</li> <li><b>3</b> Press the  button to return to the <b>MAIN MENU</b>.</li> </ol>	Press the <b>Exit</b> button (repeatedly if necessary).
<b>6</b>	Close the OSD window.	<ol style="list-style-type: none"> <li><b>1</b> Press the  button to select <b>EXIT</b> if necessary.</li> <li><b>2</b> Press the  button.</li> </ol>	

When settings are modified, all changes are saved when the user does the following:

- Proceeds to another menu.
- Exits the OSD menu.
- Waits for the OSD menu to disappear.

**Note:** Availability of some menu items depend on the input source signal. If the menu is not available, it is disabled and grayed out.

# ON SCREEN DISPLAY MENU

## 4.2 OSD Menu Tree

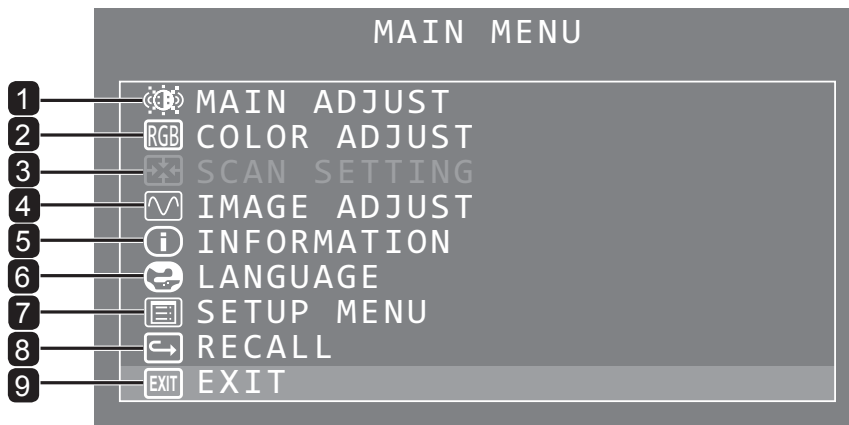

Main Menu	Submenu	Remarks
1. MAIN ADJUST	<ul style="list-style-type: none"> <li>• VIVID MODE</li> <li>• BRIGHTNESS</li> <li>• CONTRAST</li> <li>• SHARPNESS</li> <li>• SATURATION</li> <li>• TINT</li> <li>• VOLUME</li> <li>• EXIT</li> </ul>	Refer to page 36.
2. COLOR ADJUST	<ul style="list-style-type: none"> <li>• COLOR ADJUST                             <ul style="list-style-type: none"> <li>• RED(*)</li> <li>• GREEN(*)</li> <li>• BLUE*</li> </ul> </li> <li>• EXIT</li> </ul> <p><b>NOTE*:</b> <i>RED, GREEN, and BLUE can be adjusted only if the <b>COLOR ADJUST</b> is set to <b>USER COLOR</b>.</i></p>	Refer to page 38.
3. SCAN SETTING [only available if the input source is Video or S-Video]	<ul style="list-style-type: none"> <li>• SCAN SETTING                             <ul style="list-style-type: none"> <li>• UNDERSCAN</li> <li>• OVERSCAN</li> <li>• Normal [for SC-17AH/SC-19AH model in AHD/TVI mode]</li> <li>• Letterbox [for SC-17AH/SC-19AH model in AHD/TVI mode]</li> <li>• 4 : 3 [for SC-22AH/SC-24AH/SC-32AH/SC-42AH model only]</li> </ul> </li> <li>• EXIT</li> </ul>	Refer to page 40.

# ON SCREEN DISPLAY MENU

Main Menu	Submenu	Remarks
4. IMAGE ADJUST [only available if the input source is VGA]	<ul style="list-style-type: none"> <li>• AUTO ADJUST</li> <li>• H. POSITION</li> <li>• V. POSITION</li> <li>• PHASE</li> <li>• CLOCK</li> <li>• EXIT</li> </ul>	Refer to page 41.
5. INFORMATION	<ul style="list-style-type: none"> <li>• H. FREQUENCY</li> <li>• V. FREQUENCY</li> <li>• RESOLUTION</li> </ul>	Refer to page 43.
6. LANGUAGE	<ul style="list-style-type: none"> <li>• ENGLISH</li> <li>• FRANÇAIS</li> <li>• DEUTSCH</li> <li>• ESPAÑOL</li> <li>• ITALIANO</li> <li>• DUTCH</li> <li>• PORTUGUÊS</li> <li>• EXIT</li> </ul>	Refer to page 44.
7. SETUP MENU	<ul style="list-style-type: none"> <li>• OSD TIMEOUT</li> <li>• GREEN MODE</li> <li>• ANTI-BURN-IN</li> <li>• EXIT</li> </ul>	Refer to page 44.
8. RECALL		Refer to page 46.
9. EXIT		Refer to page 46.

# CHAPTER 5: ADJUSTING THE LED-BACKLIT DISPLAY

## 5.1 Main Adjust

**Note:** The remote control function is supported only for SC-32AH and SC-42AH model.

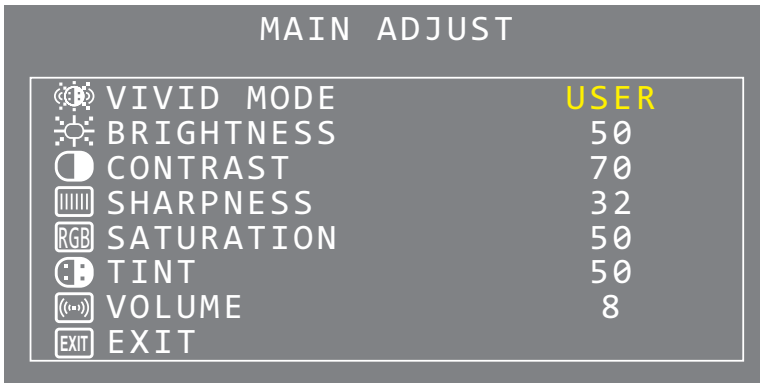

1. Press the button on the control panel or the **Menu** button/**OK** button on the remote control to call out the OSD window.
2. Press the or button on the control panel or the remote control to select **MAIN ADJUST** and press the button on the control panel or the **Menu** button/**OK** button on the remote control to enter **MAIN ADJUST** menu.
3. Press the or button on the control panel or the remote control to select an item and press the button on the control panel or the **Menu** button/**OK** button on the remote control to enter its submenu.

Item	Function	Operation		Range
		Control Panel	Remote Control	
VIVID MODE	Select a predefined picture setting. <b>Note:</b> The default mode is <b>USER</b> .	Press the  or  button [for SC-17AH/SC-19AH/SC-32AH model] or the  or  button [for SC-22AH/SC-24AH/SC-42AH model] to set the value.	Press the  or  button [for SC-32AH model] or the  or  button [for SC-42AH model] to set the value.	0 1 2 3 USER
BRIGHTNESS	Adjusts the luminance of the screen image. <b>Note:</b> <ul style="list-style-type: none"> <li>The default value is <b>50</b>.</li> <li>Brightness can be adjusted only if <b>VIVID MODE</b> is set to <b>USER</b>.</li> </ul>	Press the  or  button [for SC-17AH/SC-19AH/SC-32AH model] or the  or  button [for SC-22AH/SC-24AH/SC-42AH model] to set the value.	Press the  or  button [for SC-32AH model] or the  or  button [for SC-42AH model] to set the value.	0 to 100
BRIGHTNESS		<b>Original Setting</b> 	<b>High Setting</b> 	<b>Low Setting</b> 

# ADJUSTING THE LED-BACKLIT DISPLAY





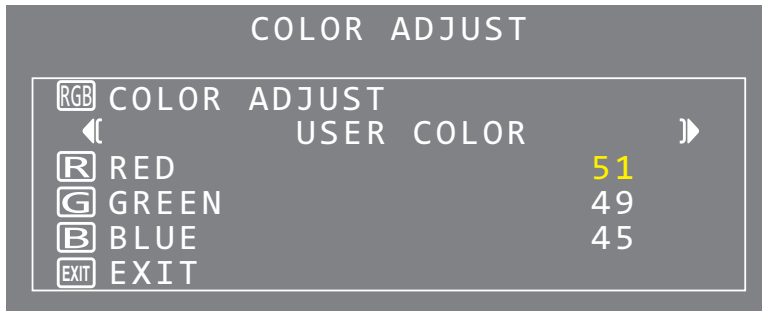

Item	Function	Operation		Range
		Control Panel	Remote Control	
CONTRAST	<p>Adjusts the difference between the black level and the white level.</p> <p><b>Note:</b></p> <ul style="list-style-type: none"> <li>The default value is <b>50</b>.</li> <li>Contrast can be adjusted only if <b>VIVID MODE</b> is set to <b>USER</b>.</li> </ul>	<p>Press the ▲ or ▼ button [for SC-17AH/SC-19AH/SC-32AH model] or the ◀ or ▶ button [for SC-22AH/SC-24AH/SC-42AH model] to set the value.</p>	<p>Press the ▲ or ▼ button [for SC-32AH model] or the ◀ or ▶ button [for SC-42AH model] to set the value.</p>	0 to 100
SHARPNESS [available with Video, S-Video, and HDMI input only]	<p>Adjusts the clarity and focus of the screen image.</p> <p><b>Note:</b></p> <ul style="list-style-type: none"> <li>The default value is <b>50</b>.</li> <li>Sharpness can be adjusted only if <b>VIVID MODE</b> is set to <b>USER</b>.</li> </ul>	<p>Press the ▲ or ▼ button [for SC-17AH/SC-19AH/SC-32AH model] or the ◀ or ▶ button [for SC-22AH/SC-24AH/SC-42AH model] to set the value.</p>	<p>Press the ▲ or ▼ button [for SC-32AH model] or the ◀ or ▶ button [for SC-42AH model] to set the value.</p>	0 to 100
SATURATION [available with Video, S-Video, and HDMI input only]	<p>Adjusts the color saturation.</p> <p><b>Note:</b></p> <ul style="list-style-type: none"> <li>The default value is <b>50</b>.</li> <li>Saturation can be adjusted only if <b>VIVID MODE</b> is set to <b>USER</b>.</li> </ul>	<p>Press the ▲ or ▼ button [for SC-17AH/SC-19AH/SC-32AH model] or the ◀ or ▶ button [for SC-22AH/SC-24AH/SC-42AH model] to set the value.</p>	<p>Press the ▲ or ▼ button [for SC-32AH model] or the ◀ or ▶ button [for SC-42AH model] to set the value.</p>	0 to 100
TINT [available with Video, S-Video, and HDMI input only]	<p>Adjusts the color tint.</p> <p><b>Note:</b></p> <ul style="list-style-type: none"> <li>The default value is <b>50</b>.</li> <li>Tint can be adjusted only if <b>VIVID MODE</b> is set to <b>USER</b>.</li> </ul>	<p>Press the ▲ or ▼ button [for SC-17AH/SC-19AH/SC-32AH model] or the ◀ or ▶ button [for SC-22AH/SC-24AH/SC-42AH model] to set the value.</p>	<p>Press the ▲ or ▼ button [for SC-32AH model] or the ◀ or ▶ button [for SC-42AH model] to set the value.</p>	0 to 100
VOLUME	<p>Adjusts the volume level of the built-in speaker.</p> <p><b>Note:</b> The default value is <b>50</b>.</p>	<p>Press the ▲ or ▼ button [for SC-17AH/SC-19AH/SC-32AH model] or the ◀ or ▶ button [for SC-22AH/SC-24AH/SC-42AH model] to set the value.</p>	<p>Press the ▲ or ▼ button [for SC-32AH model] or the ◀ or ▶ button [for SC-42AH model] to set the value.</p>	0 to 100
EXIT	Exits the submenu.	Press the  button to exit the submenu.	Press the <b>Exit</b> button to exit the submenu.	

# ADJUSTING THE LED-BACKLIT DISPLAY



## 5.2 Color Adjust

**Note:** The remote control function is supported only for SC-32AH and SC-42AH model.



1. Press the  button on the control panel or the **Menu** button/**OK** button on the remote control to call out the OSD window.
2. Press the  or  button on the control panel or the remote control to select **COLOR ADJUST** and press the  button on the control panel or the **Menu** button/**OK** button on the remote control to enter **COLOR ADJUST** menu.
3. Press the  or  button on the control panel or the remote control to select an item and press the  button on the control panel or the **Menu** button/**OK** button on the remote control to enter its submenu.

# ADJUSTING THE LED-BACKLIT DISPLAY





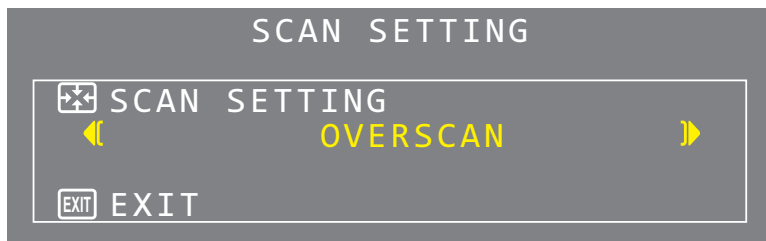

Item	Function	Operation		Range
		Control Panel	Remote Control	
COLOR ADJUST	<p>Operates the white balance and automatically adjusts the color settings.</p> <p><b>Note:</b> The default value is <b>6500</b>.</p> <p><b>COLOR ADJUST</b> can be set to:</p> <ul style="list-style-type: none"> <li>• <b>6500</b> - This is the default color temperature commonly used for normal lighting conditions.</li> <li>• <b>9300</b> - Applies a bluish tint for cooler colors.</li> <li>• <b>USER COLOR</b> - This allows users to set the color temperature by adjusting the red, green, or blue setting according to one's preference.</li> </ul> <p>a) Select <b>USER COLOR</b> and press the  button on the control panel or the <b>Menu</b> button/<b>OK</b> button on the remote control.</p> <p>b) Press the ▲ or ▼ button on the control panel or the remote control to select the color you want to adjust (<b>RED</b>, <b>GREEN</b>, or <b>BLUE</b>). Then press the  button on the control panel or the <b>Menu</b> button/<b>OK</b> button on the remote control to enter its submenu.</p> <p>c) Press the ▲ or ▼ button [for SC-17AH/SC-19AH/SC-32AH model] on the control panel or the remote control or the ◀ or ▶ button [for SC-22AH/SC-24AH/SC-42AH model only] on the control panel or the remote control to adjust the value.</p>	<p>Press the ▲ or ▼ button [for SC-17AH/SC-19AH/SC-32AH model] or the ◀ or ▶ button [for SC-22AH/SC-24AH/SC-42AH model] to set the value.</p>	<p>Press the ▲ or ▼ button [for SC-32AH model] or the ◀ or ▶ button [for SC-42AH model] to set the value.</p>	<p>6500 9300 USER COLOR</p>
EXIT	Exits the submenu.	Press the  button to exit the submenu.	Press the <b>Exit</b> button to exit the submenu.	

# ADJUSTING THE LED-BACKLIT DISPLAY









## 5.3 Scan Settings

**Note:** The remote control function is supported only for SC-32AH and SC-42AH model.





1. Press the  button on the control panel or the **Menu** button/**OK** button on the remote control to call out the OSD window.
2. Press the  or  button on the control panel or the remote control to select **SCAN SETTING** and press the  button on the control panel or the **Menu** button/**OK** button on the remote control to enter **SCAN SETTING** menu.
3. Press the  or  button on the control panel or the remote control to select an item and press the  button on the control panel or the **Menu** button/**OK** button on the remote control to enter its submenu.

**Note:** Available with Video and S-Video input sources only.

Item	Function	Operation		Range
		Control Panel	Remote Control	
SCAN SETTING	<p>Selects the aspect ratio of the screen image.</p> <p><b>Note:</b> The default value is <b>UNDERSCAN</b>.</p> <p>Scan Setting can be set to:</p> <ul style="list-style-type: none"> <li>• <b>UNDERSCAN</b> - The picture is displayed in full screen.</li> <li>• <b>OVERSCAN</b> - The picture is displayed in full screen while retaining the original aspect ratio. This results in a zoomed image and some parts of the picture may appear cut-off.</li> <li>• <b>Normal</b> - The picture is displayed in full screen with the aspect ratio 4:3 and a black band is displayed at the top and bottom.</li> <li>• <b>Letterbox</b> - The picture is enlarged to 21:9 format and a black band is displayed at the top and bottom.</li> <li>• <b>4:3</b> - The picture is displayed in full screen with the aspect ratio 4:3.</li> </ul>	<p>Press the  or  button [for SC-17AH/SC-19AH/SC-32AH model] or the  or  button [for SC-22AH/SC-24AH/SC-42AH model] to set the value.</p>	<p>Press the  or  button [for SC-32AH model] or the  or  button [for SC-42AH model] to set the value.</p>	<p>UNDERSCAN OVERSCAN 4:3 [available in SC-22AH/SC-24AH/SC-32AH/SC-42AH model only] Normal [for SC-17AH/SC-19AH model in AHD/TVI mode] Letterbox [for SC-17AH/SC-19AH model in AHD/TVI mode]</p>

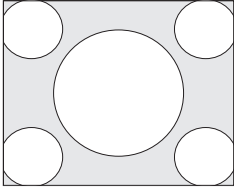
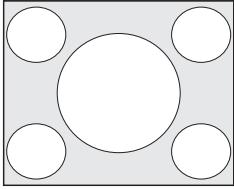
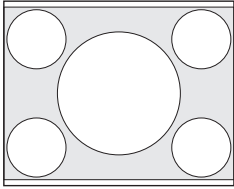
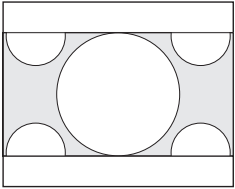
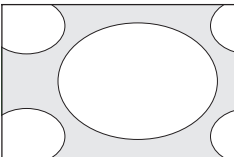
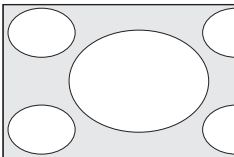
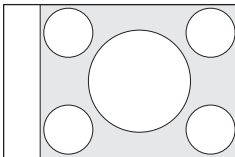

# ADJUSTING THE LED-BACKLIT DISPLAY



Item	Function	Operation		Range	
		Control Panel	Remote Control		
SCAN SETTING	<i>SC-17AH/SC-19AH Overscan</i>	<i>SC-17AH/SC-19AH Underscan</i>	<i>SC-17AH/SC-19AH (AHD/ TVI mode) Normal</i>	<i>SC-17AH/SC-19AH (AHD/ TVI mode) Letterbox</i>	
					
	<i>SC-22AH/SC-24AH/SC- 32AH/SC-42AH Overscan</i>	<i>SC-22AH/SC-24AH/SC- 32AH/SC-42AH Underscan</i>	<i>SC-22AH/SC-24AH/SC- 32AH/SC-42AH 4:3</i>		
					
	EXIT	Exits the submenu.	Press the  button to exit the submenu.	Press the <b>Exit</b> button to exit the submenu.	

## 5.4 Image Adjust

### Note:

- The remote control function is supported only for SC-32AH and SC-42AH model.
- Available with the VGA input source only.



1. Press the  button on the control panel or the **Menu** button/**OK** button on the remote control to call out the OSD window.
2. Press the **▲** or **▼** button on the control panel or the remote control to select **IMAGE ADJUST** and press the  button on the control panel or the **Menu** button/**OK** button on the remote control to enter **IMAGE ADJUST** menu.
3. Press the **▲** or **▼** button on the control panel or the remote control to select an item and press the  button on the control panel or the **Menu** button/**OK** button on the remote control to enter its submenu.

# ADJUSTING THE LED-BACKLIT DISPLAY

Item	Function	Operation		Range
		Control Panel	Remote Control	
AUTO ADJUST	<p>Press to perform auto adjustment. This function automatically tunes the LED-backlit display to its optimal setting, including horizontal position, vertical position, clock, and phase.</p> <p>When auto adjustment is initiated, the below message is displayed on the screen.</p> <div style="background-color: #cccccc; padding: 5px; text-align: center;"> <p>INFORMATION</p> <p>AUTO ADJUST</p> </div> <p>When the message disappears, this indicates the auto adjustment is completed.</p> <p><b>Note:</b></p> <ul style="list-style-type: none"> <li>• <i>During auto adjustment, the screen will slightly shake for a few seconds.</i></li> <li>• <i>It is recommended to use the auto adjustment function when using the LED-backlit display for the first time or after a resolution or frequency change.</i></li> </ul>	Press the  button to execute the function.	Press the <b>Menu</b> button/ <b>OK</b> button to execute the function.	
H. POSITION (Horizontal Position)	<p>Moves the screen image to the left or right.</p> <p><b>Note:</b> <i>The default value is 53.</i></p>	Press the ▲ or ▼ button [for SC-17AH/SC-19AH/SC-32AH model] or the ◀ or ▶ button [for SC-22AH/SC-24AH/SC-42AH model] to set the value.	Press the ▲ or ▼ button [for SC-32AH model] or the ◀ or ▶ button [for SC-42AH model] to set the value.	0 to 100
V. POSITION (Vertical Position)	<p>Moves the screen image up or down.</p> <p><b>Note:</b> <i>The default value is 31.</i></p>	Press the ▲ or ▼ button [for SC-17AH/SC-19AH/SC-32AH model] or the ◀ or ▶ button [for SC-22AH/SC-24AH/SC-42AH model] to set the value.	Press the ▲ or ▼ button [for SC-32AH model] or the ◀ or ▶ button [for SC-42AH model] to set the value.	0 to 100

# ADJUSTING THE LED-BACKLIT DISPLAY



Item	Function	Operation		Range
		Control Panel	Remote Control	
PHASE	Adjusts the phase timing to synchronize with the video signal. <b>Note:</b> <i>The default value is 17.</i>	Press the ▲ or ▼ button [for SC-17AH/ SC-19AH/SC-32AH model] or the ◀ or ▶ button [for SC-22AH/ SC-24AH/SC-42AH model] to set the value.	Press the ▲ or ▼ button [for SC-32AH model] or the ◀ or ▶ button [for SC-42AH model] to set the value.	0 to 100
CLOCK	Adjusts the frequency timing to synchronize with the video signal. <b>Note:</b> <i>The default value is 50.</i>	Press the ▲ or ▼ button [for SC-17AH/ SC-19AH/SC-32AH model] or the ◀ or ▶ button [for SC-22AH/ SC-24AH/SC-42AH model] to set the value.	Press the ▲ or ▼ button [for SC-32AH model] or the ◀ or ▶ button [for SC-42AH model] to set the value.	0 to 100
EXIT	Exits the submenu.	Press the  button to exit the submenu.	Press the <b>Exit</b> button to exit the submenu.	

## 5.5 Information

**Note:** *The remote control function is supported only for SC-32AH and SC-42AH model.*

### INFORMATION

H. FREQUENCY	44.9KHZ
V. FREQUENCY	59.9HZ
RESOLUTION	1280X720





1. Press the  button on the control panel or the **Menu** button/**OK** button on the remote control to call out the OSD window.
2. Press the ▲ or ▼ button on the control panel or the remote control to select **INFORMATION** and press the  button on the control panel or the **Menu** button/**OK** button on the remote control to view the frequency and resolution information. (Press the  button again on the control panel or the **Exit** button on the remote control to exit the **INFORMATION** menu).







# ADJUSTING THE LED-BACKLIT DISPLAY

## 5.6 Language

**Note:** The remote control function is supported only for SC-32AH and SC-42AH model.









1. Press the  button on the control panel or the **Menu** button/**OK** button on the remote control to call out the OSD window.
2. Press the  or  button on the control panel or the remote control to select **LANGUAGE** and press the  button on the control panel or the **Menu** button/**OK** button on the remote control to enter **LANGUAGE** menu.

Item	Function	Operation		Range
		Control Panel	Remote Control	
LANGUAGE	Choose the language used for OSD menus. <b>Note:</b> The default language is <i>English</i> .	Press the  or  button to select the desired language and then press the  button.	Press the  or  button to select the desired language and then press the <b>Menu</b> button/ <b>OK</b> button.	ENGLISH FRANÇAIS DEUTSCH ESPAÑOL ITALIANO DUTCH PORTUGUÊS
EXIT	Exits the submenu.	Press the  button to exit the submenu.	Press the <b>Exit</b> button to exit the submenu.	



## 5.7 Setup Menu

**Note:** The remote control function is supported only for SC-32AH and SC-42AH model.



1. Press the  button on the control panel or the **Menu** button/**OK** button on the remote control to call out the OSD window.
2. Press the  or  button on the control panel or the remote control to select **SETUP MENU** and press the  button on the control panel or the **Menu** button/**OK** button on the remote control to enter **SETUP MENU** submenu.
3. Press the  or  button on the control panel or the remote control to select an item and press the  button on the control panel or the **Menu** button/**OK** button on the remote control to enter its submenu.

# ADJUSTING THE LED-BACKLIT DISPLAY





Item	Function	Operation		Range
		Control Panel	Remote Control	
OSD TIMEOUT	<p>Sets the length of time (in seconds) the OSD screen is displayed. When the time elapses, the OSD screen is automatically inactivated.</p> <p><b>Note:</b> <i>The default value is 15 sec.</i></p>	<p>Press the ▲ or ▼ button [for SC-17AH/ SC-19AH/SC-32AH model] or the ◀ or ▶ button [for SC-22AH/ SC-24AH/SC-42AH model] to set the value.</p>	<p>Press the ▲ or ▼ button [for SC-32AH model] or the ◀ or ▶ button [for SC-42AH model] to set the value.</p>	5 sec to 120 sec
GREEN MODE	<p>Reduces the screen backlight when the LED-backlit display is inactive.</p> <p><b>Note:</b> <i>The default value is OFF.</i></p> <p><b>GREEN MODE</b> can be set to:</p> <ul style="list-style-type: none"> <li>• <b>ON (5 min to 10 min)</b> - The screen will reduce the backlight to 80% if inactive within 5 to 10 minutes.</li> <li>• <b>OFF</b> - The function is off.</li> </ul>	<p>Press the ▲ or ▼ button [for SC-17AH/ SC-19AH/SC-32AH model] or the ◀ or ▶ button [for SC-22AH/ SC-24AH/SC-42AH model] to set the value.</p>	<p>Press the ▲ or ▼ button [for SC-32AH model] or the ◀ or ▶ button [for SC-42AH model] to set the value.</p>	<p>OFF</p> <p>5 min to 10 min</p>
ANTI-BURN-IN	<p>Prevents image retention (burn-in). When <b>ANTI-BURN-IN</b> is set to <b>ON</b>, the below message is displayed on the screen.</p> <div style="background-color: #cccccc; padding: 5px; text-align: center; font-size: small;"> <p>INFORMATION</p> <p>ANTI-BURN-IN</p> </div> <p><b>Note:</b> <i>The default value is OFF.</i></p> <p><b>ANTI-BURN-IN</b> can be set to:</p> <ul style="list-style-type: none"> <li>• <b>ON</b> - Every after an hour an Anti-Burn-In scan line appears on the screen moving from the top edge towards the bottom edge of the screen with an interval one second.</li> </ul> <p><i>ANTI-BURN-IN scan line</i></p>  <ul style="list-style-type: none"> <li>• <b>OFF</b> - The function is off.</li> </ul>	<p>Press the ▲ or ▼ button to select <b>ANTI-BURN-IN</b> and then press the  button.</p>	<p>Press the ▲ or ▼ button to select <b>ANTI-BURN-IN</b> and then press the <b>Menu</b> button/<b>OK</b> button.</p>	<p>OFF</p> <p>ON</p>

# ADJUSTING THE LED-BACKLIT DISPLAY

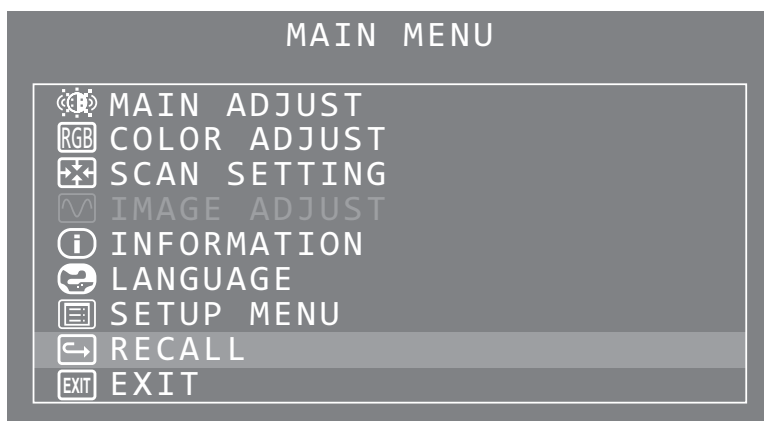
Item	Function	Operation		Range
		Control Panel	Remote Control	
EXIT	Exits the submenu.	Press the  button to exit the submenu.	Press the <b>Exit</b> button to exit the submenu.	





## 5.8 Recall

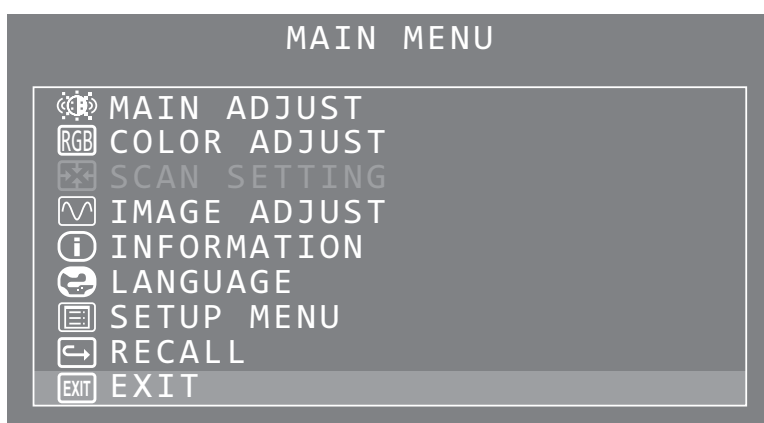

1. Press the  button on the control panel or the **Menu** button/**OK** button on the remote control to call out the OSD window.
2. Press the  or  button on the control panel or the remote control to select **RECALL**.
3. Press the  button on the control panel or the **Menu** button/**OK** button on the remote control to reset **BRIGHTNESS, CONTRAST, SHARPNESS, SATURATION, TINT, VOLUME, VIVID MODE, USER COLOR, AHD/TVI SCAN SETTING (SC-17AH, SC-19AH only), OSD TIMEOUT, GREEN MODE,** and **ANTI-BURN-IN** values to their factory defaults.



## 5.9 Exit



1. Press the  button on the control panel or the **Menu** button/**OK** button on the remote control to call out the OSD window.
2. Do any of the following to select **EXIT**:
  - On the control panel, press the  or  button to select **EXIT** and press the  button to exit the OSD window.
  - On the remote control, press the **EXIT** button.

# CHAPTER 6: APPENDIX

## 6.1 Warning Messages

Warning Messages	Cause	Solution
 A screenshot of a warning message on a screen. It shows a dark grey rectangular box with the word "INFORMATION" in small white capital letters at the top, and "NO SIGNAL" in larger white capital letters below it.	The LED-backlit display cannot detect the input source signal.	<ul style="list-style-type: none"><li>• Check if the input source is turned ON.</li><li>• Check if the signal cable is properly connected.</li><li>• Check if any pin inside the cable connector is twisted or broken.</li></ul>
 A screenshot of a warning message on a screen. It shows a dark grey rectangular box with a small white icon of a key with a slash through it, followed by the text "KEY LOCK" in white capital letters.	The <b>KEY LOCK</b> function is activated by the user to prevent accidental changes to the screen settings.	<ul style="list-style-type: none"><li>• Disable the <b>KEY LOCK</b> function. Refer to page 28.</li></ul>

# APPENDIX

## 6.2 Troubleshooting

Problems	Possible Cause and Solution
<p>No picture.</p> <ul style="list-style-type: none"> <li>• LED indicator is OFF.</li> </ul>	<ul style="list-style-type: none"> <li>• Check if the LED-backlit display is turned ON.</li> <li>• Check if the power cord is properly connected to the LED-backlit display.</li> <li>• Check if the power cord is plugged into the power outlet.</li> </ul>
Image position is incorrect.	<ul style="list-style-type: none"> <li>• For VGA input, perform <b>AUTO ADJUST</b> or adjust manually <b>H. POSITION</b> and <b>V. POSITION</b> settings in <b>IMAGE ADJUST</b> menu (refer to page 41).</li> <li>• For Video and S-Video input, select an appropriate aspect ratio in <b>SCAN SETTING</b> menu (refer to page 40).</li> </ul>
The displayed texts are blurry.	<ul style="list-style-type: none"> <li>• For VGA input, perform <b>AUTO ADJUST</b> or adjust manually <b>CLOCK</b> and <b>PHASE</b> settings in <b>IMAGE ADJUST</b> menu (refer to page 41)</li> </ul>
Red, blue, green, white dots appear on the screen.	<ul style="list-style-type: none"> <li>• There are millions of micro transistors inside the LED-backlit display. It is normal for a few transistors to be damaged and to produce spots. This is acceptable and is not considered a failure.</li> </ul>
No audio output.	<ul style="list-style-type: none"> <li>• Check if the volume is set to 0 (refer to page 27 or page 28).</li> <li>• For VGA input, check the audio setting of the computer.</li> </ul>
Dew formed on or inside the LED-backlit display.	<ul style="list-style-type: none"> <li>• This normally happens when the LED-backlit display is moved from a cold room to a hot room temperature. Do not turn ON the LED-backlit display, wait for the dew condensation to disappear.</li> </ul>
Mist formed inside the glass surface.	<ul style="list-style-type: none"> <li>• This happens due to humid weather conditions. This is a normal occurrence. The mist will disappear after a few days or as soon as the weather stabilizes.</li> </ul>
Faint shadows from a static image appear on the screen.	<ul style="list-style-type: none"> <li>• Turn off the LED-backlit display for extended periods of time.</li> <li>• Use a screen saver or a black and white image and run it for extended periods of time.</li> </ul>



# CHAPTER 7: SPECIFICATIONS

## 7.1 Display Specifications

Item		Model Name					
		SC-17AH	SC-19AH	SC-22AH	SC-24AH	SC-32AH	SC-42AH
<b>Electrical Characteristics</b>							
Panel	Panel Size	17"	19"	21.5"	24"	31.5"	42"
	Max. Resolution	1280x1024		1920x1080			
	Brightness	250cd/m <sup>2</sup>				300cd/m <sup>2</sup>	400cd/m <sup>2</sup>
	Contrast Ratio	≥1000:1			1000:1	3000:1	
	Viewing Angle (H/V)	170°/ 160°				178°/ 178°	
	Display Color	16.7M					
	Response Time	≥5ms					
Frequency (H/V)		H: 31.5kHz – 82kHz V: 50Hz – 75Hz				H: 31.5kHz – 80kHz V: 50Hz – 75Hz	
Input	VGA	15-Pin D-Sub					
	AHD 2.0/ TVI 2.0/ CVBS	BNC					
	S-Video	4-pin mini DIN					
	HDMI	HDMI					
Output	AHD 2.0/ TVI 2.0/ CVBS	BNC					
Audio	Audio In/Out	2 x stereo audio jack (3.5mm)					
	Speaker	1W x2				2W x2	
Power	Power Supply	Internal					
	Power Type	AC 100 – 240 V, 50-60 Hz					
	Consumption	≤15W	≤18W	≤22W	≤23W	≤57W	≤77W
<b>Physical Characteristics</b>							
Operating Conditions	Temperature	0°C ~ 40°C (32°F ~ 104°F)					
	Humidity	10% ~ 85% (non-condensing)					
Storage Conditions	Temperature	-20°C ~ 60°C (-4°F ~ 140°F)				-10°C ~ 50°C (14°F ~ 122°F)	
	Humidity	10% ~ 95% (non-condensing)					
Dimensions (WxHxD)		372 x 385 x 184 mm (14.6" x 15.2" x 7.2")	418 x 412 x 184 mm (16.5" x 16.2" x 7.2")	517 x 376 x 185 mm (20.4" x 14.8" x 7.3")	577 x 407 x 223 mm (22.7" x 16.0" x 8.8")	744 x 532.6 x 199.2 mm (29.3" x 20.96" x 7.8")	992.3 x 656 x 240 mm (39.1" x 25.8" x 9.4")
Weight	With Stand	2.9 kg (6.4 lbs)	3.6 kg (7.9 lbs)	3.4 kg (7.5 lbs)	3.6 kg (8.0 lbs)	9.25 kg (20.4 lbs)	14.5 kg (32.0 lbs)
	Without Stand	2.7 kg (6.0 lbs)	3.4 kg (7.5 lbs)	3.2 kg (7.1 lbs)	3.4 kg (7.5 lbs)	8.5 kg (18.7 lbs)	13.5 kg (29.8 lbs)

**Note:** All specifications are subject to change without prior notice.

# SPECIFICATIONS

## 7.2 Display Dimensions

### SC-17AH

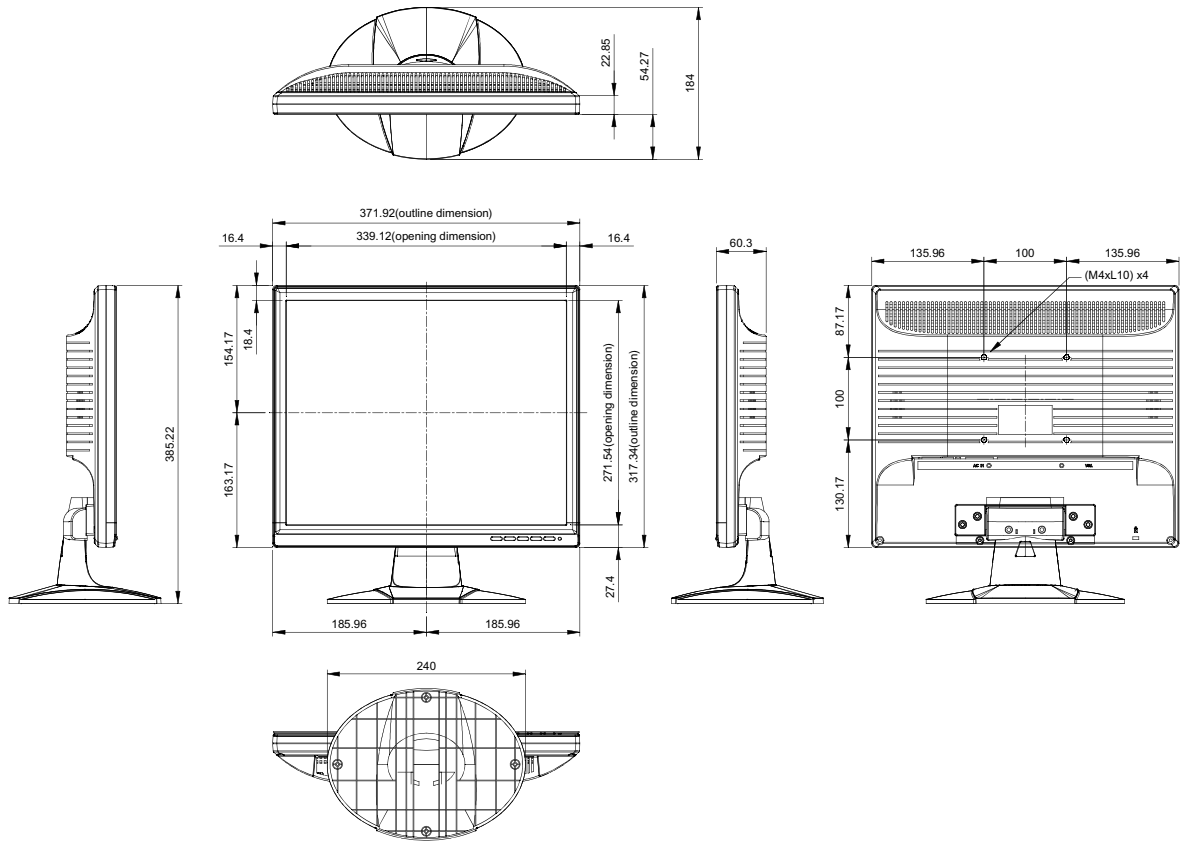

### SC-19AH

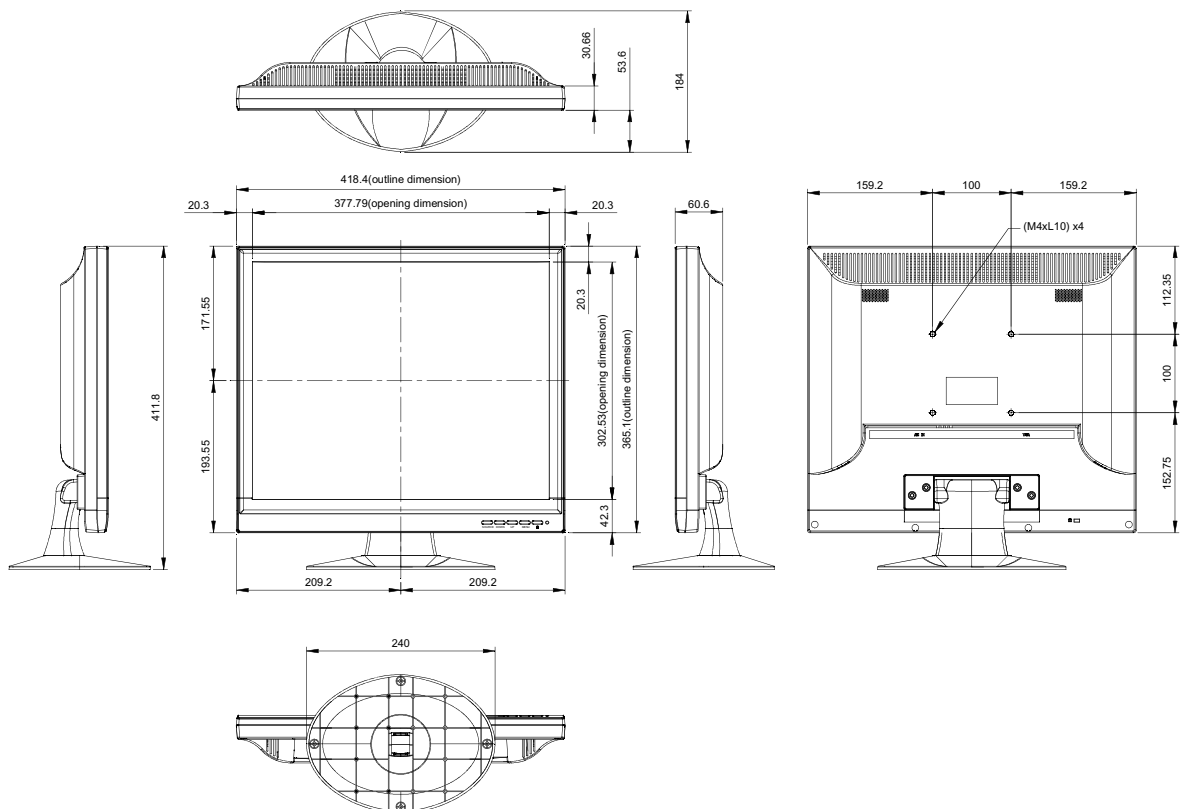

# SPECIFICATIONS

## SC-22AH

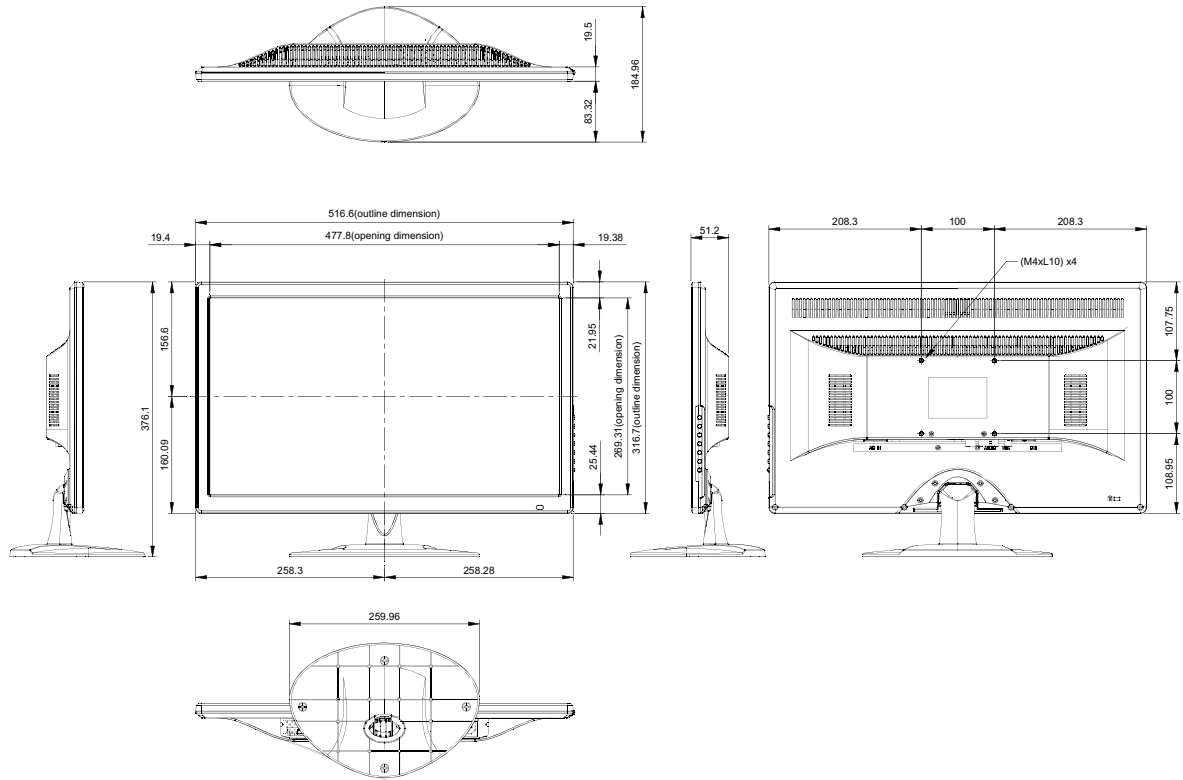

## SC-24AH

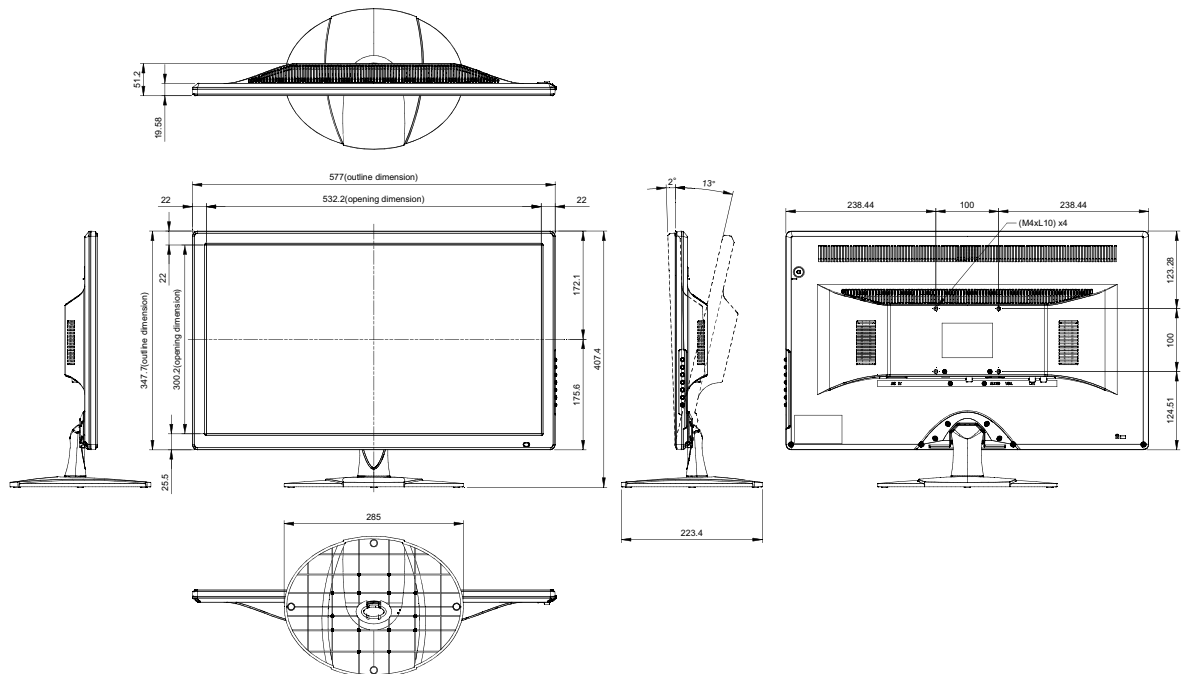

# SPECIFICATIONS

## SC-32AH

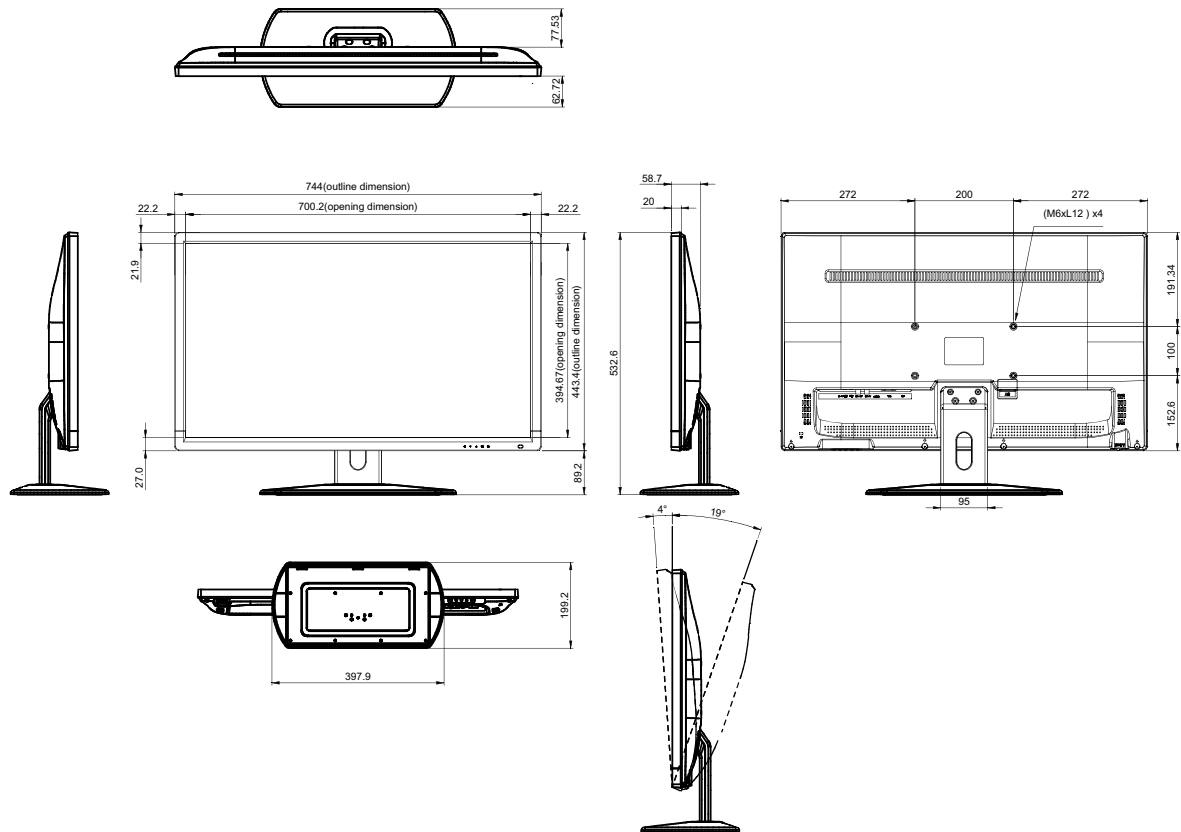

## SC-42AH

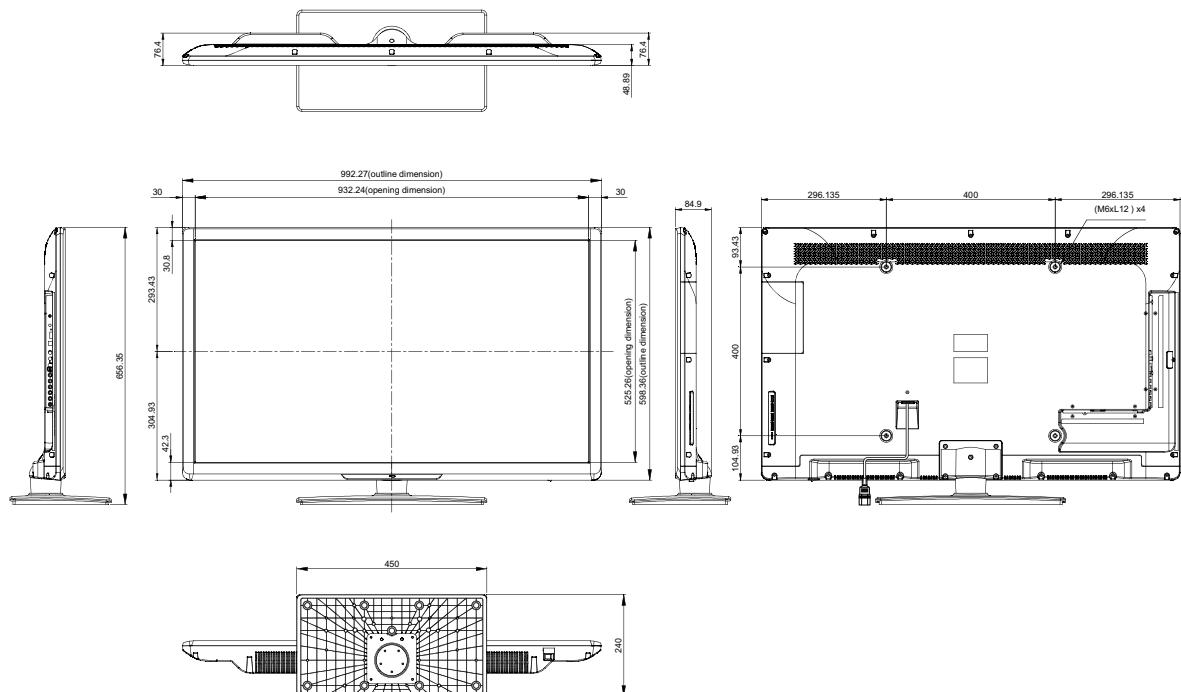

Company Address: 5F-1, No. 3-1, Park Street, Nangang District, Taipei, 11503, Taiwan.

Copyright © 2017 AG Neovo. All Rights Reserved.

SC-17/19/22/24/32/42AH\_UM\_V030