

**THE DISPLAY CHOICE
OF PROFESSIONALS™**

www.agneovo.com

L-Series LCD Display
User Manual

TABLE OF CONTENTS

FOR YOUR SAFETY	2
SAFETY PRECAUTIONS	2-4
SPECIAL NOTES ON LCD MONITOR	4
BEFORE YOU OPERATE THE MONITOR	5
FEATURES	5
CHECKING THE CONTENTS OF THE PACKAGE	5
INSTALLATION INSTRUCTIONS	5
CONTROLS AND CONNECTORS	6
ADJUSTING THE VIEWING ANGLE	7
OPERATING INSTRUCTIONS	7
GENERAL INSTRUCTIONS	8
FRONT PANEL CONTROL	9
HOW TO ADJUST A SETTING	10
ADJUSTING THE PICTURE	11-13
PLUG AND PLAY	14
TECHNICAL SUPPORT(FAQ)	15
ERROR MESSAGE & POSSIBLE SOLUTION	16
APPENDIX	17
SPECIFICATIONS	17
FACTORY PRESET TIMING TABLE	18
CONNECTOR PIN ASSIGNMENT	19-20

FOR YOUR SAFETY

Before operating the monitor, please read this manual thoroughly. This manual should be retained for future reference.

SAFETY PRECAUTIONS

FCC Class B Radio Frequency Interference Statement

WARNING: (FOR FCC CERTIFIED MODELS)

This device complies with Part 15 of the FCC rules. Operation is subject to the following two conditions: (1) this device may not cause harmful interference, and (2) this device must accept any interference received, including interference that may cause undesired operation.

NOTE: This equipment has been tested and found to comply with the limits for a Class B digital device, pursuant to Part 15 of the FCC Rules. These limits are designed to provide reasonable protection against harmful interference in a residential installation. This equipment generates, uses and can radiate radio frequency energy, and if not installed and used in accordance with the instructions, may cause harmful interference to radio communications. However, there is no guarantee that interference will not occur in a particular installation. If this equipment does cause harmful interference to radio or television reception, which can be determined by turning the equipment off and on, the user is encouraged to try to correct the interference by one or more of the following measures:

1. Reorient or relocate the receiving antenna.
2. Increase the separation between the equipment and receiver.
3. Connect the equipment into an outlet on a circuit different from that to which the receiver is connected.
4. Consult the dealer or an experienced radio/TV technician for help.

NOTICE:

1. The changes or modifications not expressly approved by the party responsible for compliance could void the user's authority to operate the equipment.
2. Shielded interface cables and AC power cord, if any, must be used in order to comply with the emission limits.
3. The manufacturer is not responsible for any radio or TV interference caused by unauthorized modification to this equipment. It is the responsibilities of the user to correct such interference.

WARNING:

To prevent fire or shock hazard, do not expose the monitor to rain or moisture. Dangerously high voltages are present inside the monitor. Do not open the cabinet. Refer servicing to qualified personnel only.

PRECAUTIONS

- Do not use the monitor near water, e.g. near a bathtub, washbowl, kitchen sink, laundry tub, swimming pool or in a wet basement.
- Do not place the monitor on an unstable cart, stand, or table. If the monitor falls, it can injure a person and cause serious damage to the appliance. Use only a cart or stand recommended by the manufacturer or sold with the monitor. If you mount the monitor on a wall or shelf, use a mounting kit approved by the manufacturer and follow the kit instructions.
- Slots and openings in the back and bottom of the cabinet are provided for ventilation. To ensure reliable operation of the monitor and to protect it from overheating, be sure these openings are not blocked or covered. Do not place the monitor on a bed, sofa, rug, or similar surface. Do not place the monitor near or over a radiator or heat register. Do not place the monitor in a bookcase or cabinet unless proper ventilation is provided.
- The monitor should be operated only from the type of power source indicated on the label. If you are not sure of the type of power supplied to your home, consult your dealer or local power company.
- The monitor is equipped with a three-pronged grounded plug, a plug with a third (grounding) pin. This plug will fit only into a grounded power outlet as a safety feature. If your outlet does not accommodate the three-wire plug, have an electrician install the correct outlet, or ground the appliance safely. Do not defeat the safety purpose of the grounded plug.
- Unplug the unit during a lightening storm or when it will not be used for long period of time. This will protect the monitor from damage due to power surges.
- Do not overload power strips and extension cords. Overloading can result in fire or electric shock.
- Never push any object into the slot on the monitor cabinet. It could short circuit parts causing a fire or electric shock. Never spill liquids on the monitor.
- Do not attempt to service the monitor by yourself; opening or removing covers can expose you to dangerous voltages and other hazards. Please refer all servicing to qualified service personnel.
- To ensure satisfactory operation, use the monitor only with UL listed computers which have appropriate configured receptacles marked between 100 - 240V AC, Min. 5A.
- The wall socket shall be installed near the equipment and shall be easily accessible.

WEEE DECLARATION

Disposal of Waste Equipment by Users in Private Household in the European Union.



This symbol on the product or on its packaging indicates that this product must not be disposed of with your other household waste. Instead, it is your responsibility to dispose of your waste equipment by handing it over to a designated collection point for the recycling of waste electrical and electronic equipment. The separate collection and recycling of your waste equipment at the time of disposal will help to conserve natural resources and ensure that it is recycled in a manner that protects human health and the environment. For more information about where you can drop off your waste equipment for recycling, please contact your local city office, your household waste disposal service or the shop where you purchased the product .

SPECIAL NOTES ON LCD MONITOR

The following symptoms are normal with LCD monitor and do not indicate a problem.

NOTES

- Due to the nature of the fluorescent light, the screen may flicker during initial use. Turn off the Power Switch and then turn it on again to make sure the flicker disappears.
- You may find slightly uneven brightness on the screen depending on the desktop pattern you use.
- The LCD screen has effective pixels of 99.99% or more. It may include blemishes of 0.01% or less such as a missing pixel or a pixel lit all of the time.
- Due to the nature of the LCD screen, an afterimage of the previous screen may remain after switching the image, when the same image is displayed for hours. In this case, the screen is recovered slowly by changing the image or turning off the Power Switch for hours.
- To declare the product is the Information Technical Equipment intended primarily for use in the domestic environment .
- The monitor is for computer use and not marketed and intended for displaying any television broadcast signals .

BEFORE YOU OPERATE THE MONITOR

FEATURES

- 54.69cm(21.53 inches) TFT Color LCD Monitor
- 60.97cm(24 inches) TFT Color LCD Monitor
- 68.6cm (27 inches) TFT Color LCD Monitor
- Crisp, Clear Display for Windows
- Recommended Resolutions: 1920x1080@60Hz.
- Ergonomic Design
- Space Saving, Compact Case Design

CHECKING THE CONTENTS OF THE PACKAGE

The product package should include the following items:

1. LCD Monitor
2. Owner's Manual (including CD-ROM & Warranty Card)
3. Power Cord
4. 15-pin D-Sub Cable
5. Audio Cable
6. Stand (only for L-W22 & L-W24)
7. Base

INSTALLATION INSTRUCTIONS

Install

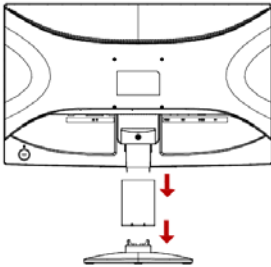

L-W22 & L-W24

Remove

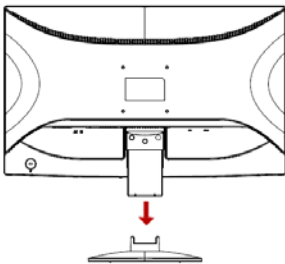
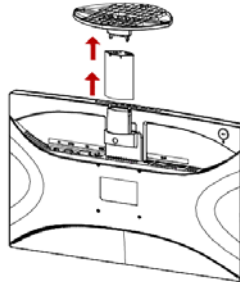

L-W27

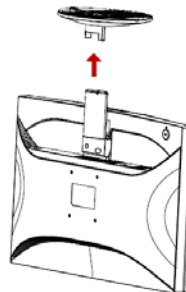

Figure 1 Installing and Removing the Base

Power Source:

1. Make sure that the power cord is the correct type required in your area.
2. This LCD monitor has an External universal power supply that allows operation in either 100/120V AC or 220/240V AC voltage area (No user adjustment is required.)
3. Connect the AC-power cord into your LCD monitor's AC-power-input. The AC-power cord may be connected to either a wall power outlet or the power outlet socket on your PC, depending on the type of power cord supplied with your LCD monitor.

CONTROLS AND CONNECTORS

SIGNAL CABLE

Connecting the Signal Cable: Plug the Signal Cable one end to LCD monitor's "D-SUB" socket, the other end to the computer's VGA port and tighten the two screws on the cable connector.

Connecting the DVI Cable: Plug the DVI Cable one end to LCD monitor's "DVI" socket, the other end to the computer's DVI port and tighten the two screws on the cable connector.

Connecting the HDMI Cable: Plug the HDMI Cable one end to the output port of HDMI video equipment, the other end to LCD monitor's "HDMI" socket.

Connecting the Power Cord: Connect the AC-power cord into your LCD monitor's "AC-IN". The AC-power cord may be connected to either a wall power outlet or the power outlet socket on your PC, depending on the type of power cord supplied with your LCD monitor.

Connecting the Audio Cable: Connect the audio cable between the monitor's "AUDIO-IN" socket and the PC's audio output (green port).

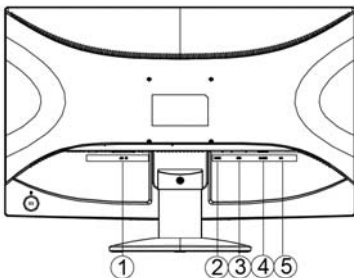

1.	AC-IN socket
2.	HDMI input socket
3.	DVI input socket
4.	D-SUB input socket
5.	AUDIO-IN socket

Figure 2 Connecting Cables

ADJUSTING THE VIEWING ANGLE

- For optimal viewing it is recommended to look at the full face of the monitor, then adjust the monitor's angle to your own preference.
- Hold the stand so you do not topple the monitor when you change the monitor's angle.
- You are able to adjust the monitor's angle from -4° to 18° .

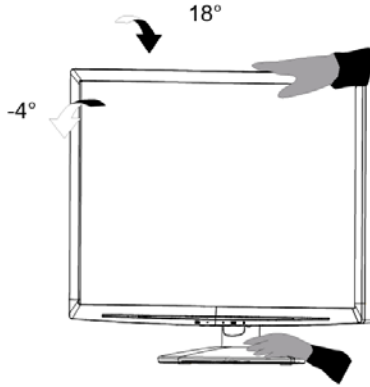

Figure 3

NOTES

- Do not touch the LCD screen when you change the angle. It may cause damage or break the LCD screen.
- Careful attention is required not to catch your fingers or hands when you change the angle.

OPERATING INSTRUCTIONS

GENERAL INSTRUCTIONS

Press the power button to turn the monitor on or off. The other control buttons are located at front panel of the monitor (See Figure 4). By changing these settings, the picture can be adjusted to your personal preferences.

- The power cord should be connected.
- Connect the video cable from the monitor to the video card.
- Press the power button to turn on the monitor position. The power indicator will light up.

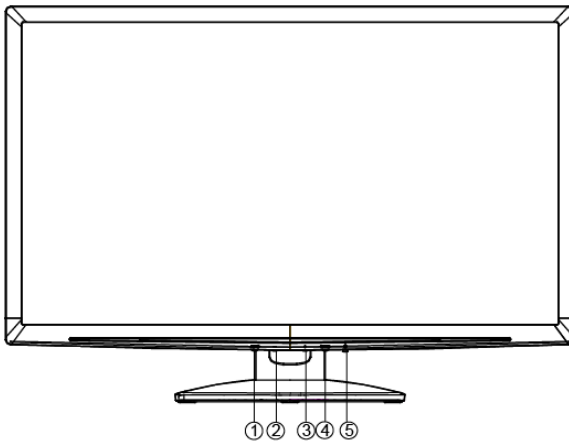

Figure 4 External Control Button

EXTERNAL CONTROLS

1.	AUTO / Source / Exit
2.	- / ECO hotkey
3.	+ / Volume+
4.	MENU / Enter
5.	Power button

FRONT PANEL CONTROL

- **⏻/Power Button:**

Press this button to turn the monitor ON or OFF, and display the monitor's state.

- **Power Indicator:**

Blue — Power On mode.

Orange — Standby mode.

- **MENU / ENTER:**

Activate OSD menu when OSD is OFF or activate/de-activate adjustment function when OSD is ON or Exit OSD menu when in Volume Adjust OSD status.

- **- / ECO hotkey:**

Activates ECO control when the OSD is off or adjust a function when function is activated.

- **+ / Volume+:**

Activates the volume control when the OSD is off or adjust a function when function is activated.

- **Auto/ Source / Exit:**

1. When OSD menu is in active status, this button will act as EXIT-KEY (EXIT OSD menu).
2. When OSD menu is in off status, press this button to select input Source: D-Sub/DVI/HDMI.
3. When OSD menu is in off status, press this button for 2 seconds to activate the Auto Adjustment function. The Auto Adjustment function is used to set the HPos, VPos, Clock and Focus.

OSD Lock Function: To lock the OSD, press and hold the MENU button while the monitor is off and then press power button to turn the monitor on. To un-lock the OSD - press and hold the MENU button while the monitor is off and then press power button to turn the monitor on.

NOTES

- Do not install the monitor in a location near heat sources such as radiators or air ducts, or in a place subject to direct sunlight, or excessive dust or mechanical vibration or shock.
- Save the original shipping carton and packing materials, as they will come in handy if you ever have to ship your monitor.
- For maximum protection, repackage your monitor as it was originally packed at the factory.
- To keep the monitor looking new, periodically clean it with a soft cloth. Stubborn stains may be removed with a cloth lightly dampened with a mild detergent solution. Never use strong solvents such as thinner, benzene, or abrasive cleaners, since these will damage the cabinet. As a safety precaution, always unplug the monitor before cleaning it.
- Do not scratch the screen with hard things, it may cause permanent damage.
- Don't leak liquid into monitor which will result in the damage of component.

HOW TO ADJUST A SETTING

1. Press the MENU-button to activate the OSD window.
2. Press - or + to navigate through the functions. Once the desired function is highlighted, press the MENU-button to activate it. If the function selected has a sub-menu, press- or + again to navigate through the sub-menu functions. Once the desired function is highlighted, press MENU-button to activate it.
3. Press - or + to change the settings of the selected function.
4. To exit and save, select the exit function. If you want to adjust any other function, repeat steps 2-3.

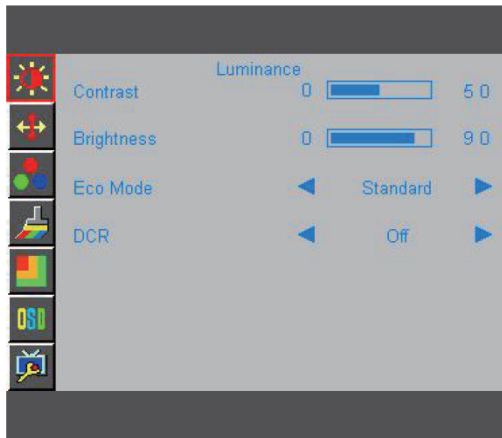









Figure 5 The OSD Message

ADJUSTING THE PICTURE

The descriptions for function control LEDS

Main Menu Item	Main Menu Icon	Sub Menu Item	Sub Menu	Description
Luminance		Brightness		Backlight Adjustment
		Contrast		Contrast from Digital-register
		Eco	Standard	Standard Mode
			Text	Text Mode
			Internet	Internet Mode
			Game	Game Mode
			Movie	Movie Mode
			Sports	Sports Mode
			DCR	Off
		On		Enable dynamic contrast ratio
Image Setup		Clock	Adjust Picture Clock to reduce Vertical-Line noise	
		Focus	Adjust Picture Phase to reduce Horizontal-Line noise	
		H.Position	Adjust the horizontal position of the picture	
		V.Position	Adjust the vertical position of the picture	

Main Menu Item	Main Menu Icon	Sub Menu Item	Sub Menu	Description
Color Temp.		Warm		Recall Warm Color Temperature from EEPROM
		Normal		Recall Normal Color Temperature from EEPROM
		Cool		Recall Cool Color Temperature from EEPROM
		sRGB		Recall sRGB Color Temperature from EEPROM
		User	User-B	Blue Gain from Digital-register
			User-G	Green Gain Digital-register
			User-R	Red Gain from Digital-register
Color Boost		Full Enhance	on or off	Disable or Enable Full Enhance Mode
		Nature Skin	on or off	Disable or Enable Nature Skin Mode
		Green Field	on or off	Disable or Enable Green Field Mode
		Sky-blue	on or off	Disable or Enable Sky-blue Mode
		AutoDetect	on or off	Disable or Enable AutoDetect Mode
		Demo	on or off	Disable or Enable Demo

Main Menu Item	Main Menu Icon	Sub Menu Item	Sub Menu	Description
Picture Boost		Frame Size		Adjust Frame Size
		Brightness		Adjust Frame Brightness
		Contrast		Adjust Frame Contrast
		H.Position		Adjust the horizontal position of Frame
		V.Position		Adjust the vertical position of Frame
		Bright Frame	on or off	Disable or Enable Bright Frame
OSD Setup		H.Position		Adjust the horizontal position of OSD
		V.Position		Adjust the vertical position of OSD
		Timeout		Adjust the OSD Timeout
		Language		Select the OSD language
Extra		Input Select	D-Sub	Select analog input source
			DVI	Select digital input source
			HDMI	Select HDMI input source
		DDC/CI		Turn ON/OFF DDC/CI Support
		Reset		Reset the menu to default
		Information		Show the information of the main image and sub-image source

PLUG AND PLAY

Plug & Play DDC1/2B Feature

This monitor is equipped with VESA DDC1/2B capabilities according to the VESA DDC STANDARD. It allows the monitor to inform the host system of its identity and, depending on the level of DDC used, communicate additional information about its display capabilities. The communication channel is defined in two levels, DDC1 and DDC2B.

The DDC1 is a unidirectional data channel from the display to the host that continuously transmits EDID information. The DDC2B is a bidirectional data channel based on the I²C protocol. The host can request EDID information over the DDC2B channel.

THIS MONITOR WILL APPEAR TO BE NON-FUNCTIONAL IF THERE IS NO VIDEO INPUT SIGNAL. IN ORDER FOR THIS MONITOR TO OPERATE PROPERLY, THERE MUST BE A VIDEO INPUT SIGNAL.

This monitor meets the Green monitor standards as set by the Video Electronics Standards Association (VESA) and The Swedish Confederation Employees (NUTEK). This feature is designed to conserve electrical energy by reducing power consumption when there is no video-input signal present. When there is no video input signal this monitor, following a time-out period, will automatically switch to an OFF mode. This reduces the monitor's internal power supply consumption. After the video input signal is restored, full power is restored and the display is automatically redrawn. The appearance is similar to a "Screen Saver" feature except the display is completely off. The display is restored by pressing a key on the keyboard, or clicking the mouse.

TECHNICAL SUPPORT (FAQ)

Problem & Question	Possible Solution
Power LED is not on	*Check if the Power Switch is in the ON position *Power Cord should be connected
No Plug & Play	*Check if the PC system is Plug & Play compatible *Check if the Video Card is Plug & Play compatible *Check if the D-15 plug pin of Video Cable is bent
Picture is fuzzy	*Adjust the Contrast and Brightness Controls.
Picture bounces or a wave pattern is present in the picture	*Move electrical devices that may cause electrical interference.
The power LED is ON but there's no video or no picture.	*Computer Power Switch should be in the ON position. *Computer Video Card should be snugly seated in its slot *Make sure monitor's video cable is properly connected to the computer. *Inspect monitor's video cable and make sure none of the pins are bent. *Make sure computer is operational by hitting the CAPS LOCK key on the keyboard while observing the CAPS LOCK LED. The LED should either turn ON or OFF after hitting the CAPS LOCK key.
Missing one of the primary colors (RED, GREEN, or BLUE)	*Inspect the monitor's video cable and make sure that none of the pins are bent.
Screen image is not centered or sized properly.	*Adjust pixel frequency (CLOCK) and FOCUS or press hot-key (AUTO)
Picture has color defects (white does not look white)	*Adjust RGB color or select color temperature
Horizontal or vertical disturbances on the screen	*Use Win95/98/2000/ME/XP shut-down mode Adjust CLOCK and FOCUS or perform hot- key (AUTO-key).

CLOCK (pixel frequency) controls the number of pixels scanned by one horizontal sweep. If the frequency is not correct, the screen shows vertical stripes and the picture has not correct width.

FOCUS adjusts the phase of the pixel clock signal. With a wrong phase adjustment the picture has horizontal disturbances in light picture.

For FOCUS and CLOCK adjustment use "dot-pattern" or Win95/98/2000/ME/XP shut-down mode pattern.

ERROR MESSAGE & POSSIBLE SOLUTION

CABLE NOT CONNECTED :

1. Check that the signal-cable is properly connected , If the connector is loose, tighten the connector's screws.
2. Check the signal -cable connection pins for damage.

INPUT NOT SUPPORT :

Your computer has been set to unsuitable display mode ,set the computer to display mode given in the following table.(page18)

APPENDIX

SPECIFICATIONS

LCD Panel	Driving system	21.5" TFT Color LCD, With LED Backlight	24" TFT Color LCD, With LED Backlight	27" TFT Color LCD, With LED Backlight
	Size	54.69cm	60.97cm	68.6 cm
	Pixel pitch	0.248mm(H)x 0.248mm(V)	0.27675mm(H)x 0.27675mm(V)	0.3114mm(H)x 0.3114(V)
Input	Video	R,G,B Analog Interface TMDS signal		
	H-Frequency	30KHz – 83KHz		
	V-Frequency	55-75Hz		
Display Colors		16.7M Colors		
Dot Clock		170MHz		
Max. Resolution		1920x1080 @60Hz		
Plug & Play		VESA DDC1/2B™		
Input Connector		D-Sub 15pin/ DVI pin24/HDMI pin19		
Input Video Signal		Analog:0.7Vp-p(standard),75OHM, Positive		
		Digital: 150≤ Vidiff ≤1200, 20MHz≤ dot clock ≤165MHz		
Maximum Screen Size		Horizontal :	Horizontal :	Horizontal :
		476.64mm Vertical : 268.11mm	531mm Vertical : 298mm	597.89mm Vertical : 336.31mm
Power Source		100~240V,50~60Hz,1.5A		
Environmental Considerations		Operating Temp: 0° to 40°C Storage Temp.: -25° to 55°C Operating Humidity: 10% to 85%		
Weight (N. W.)		3.5 kg Unit	4.3 kg Unit	5.9 kg Unit
Dimension (with Base)		505.6*365.8*180.0 mm(W*H*D)	566.0*395.1*190.0 mm(W*H*D)	642*439*209 mm (W*H*D)
Power Consumption (Maximum)		40 Watts	40 Watts	50 Watts
External Controls:	Switch	Auto/ Source / Exit - /ECO hotkey + /Volume+ Menu / Enter Power Button		
	Functions	<ul style="list-style-type: none"> ● Luminance ● Image Setup ● Color Temp. ● Color Boost ● Picture Boost ● OSD Setup ● Extra 		
Audio Output		2.0W rms (per channel)		
Regulatory Compliance		FCC、CE		

Preset Display Modes

STANDARD	RESOLUTION	HORIZONTAL Frequency(KHz)	VERTICAL Frequency (Hz)
VGA	640x480 @60Hz	31.469	59.940
	640x480 @67Hz	35.000	66.667
	640x480 @72Hz	37.861	72.809
	640x480 @75Hz	37.500	75.000
Dos-mode	720x400 @70Hz	31.469	70.087
SVGA	800x600 @56Hz	35.156	56.250
	800x600 @60Hz	37.879	60.317
	800x600 @72Hz	48.077	72.188
	800x600 @75Hz	46.875	75.000
Mac-Mode	832x624 @75Hz	49.725	74.550
XGA	1024x768 @60Hz	48.363	60.004
	1024x768 @70Hz	56.476	70.069
	1024x768 @75Hz	60.023	75.029
SXGA	1280x1024@60Hz	63.981	60.020
	1280x1024@75Hz	79.976	75.025
WSXGA	1440x900@60Hz	55.935	59.887
	1440x900@75Hz	70.635	74.984
WSXGA+	1680x1050@60Hz	64.674	59.883
	1680x1050@60Hz	65.290	59.954
	1680x1050@75Hz	82.306	74.892
FULL HD	1920x1080@60Hz	67.500	60.000

CONNECTOR PIN ASSIGNMENT

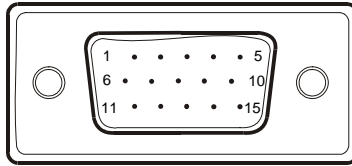

15 - Pin Color Display Signal Cable

PIN NO.	DESCRIPTION	PIN NO.	DESCRIPTION
1.	Red	9.	+5V/Sense(+5V)
2.	Green	10.	Monitor Gnd
3.	Blue	11.	Logic Gnd
4.	Logic Gnd	12.	DDC serial data
5.	Detect cable	13.	H sync
6.	Red Gnd	14.	V sync
7.	Green Gnd	15.	DDC serial Clk.
8.	Blue Gnd		

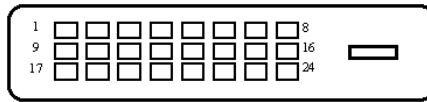

24 - Pin Color Display Signal Cable

PIN NO.	DESCRIPTION	PIN NO.	DESCRIPTION
1.	TMDS Data 2-	13.	TMDS Data 3+
2.	TMDS Data 2+	14.	+5V Power
3.	TMDS Data 2/4 Shield	15.	Ground(for+5V)
4.	TMDS Data 4-	16.	Hot Plug Detect
5.	TMDS Data 4+	17.	TMDS Data 0-
6.	DDC Clock	18.	TMDS Data 0+
7.	DDC Data	19.	TMDS Data 0/5 Shield
8.	N.C.	20.	TMDS Data 5-
9.	TMDS Data 1-	21.	TMDS Data 5+
10.	TMDS Data 1+	22.	TMDS Clock Shield
11.	TMDS Data 1/3 Shield	23.	TMDS Clock +
12.	TMDS Data 3-	24.	TMDS Clock -



HDMI Signal Cable

PIN NO.	SIGNAL NAME	PIN NO.	SIGNAL NAME	PIN NO.	SIGNAL NAME
1	TMDS Data 2+	8	TMDS Data 0 Shield	15	SCL
2	TMDS Data 2 Shield	9	TMDS Data 0	16	SDA
3	TMDS Data 2	10	TMDS Clock +	17	DDC/CEC Ground
4	TMDS Data 1+	11	TMDS Clock Shield	18	+5V Power
5	TMDS Data 1 Shield	12	TMDS Clock	19	Hot Plug Detect
6	TMDS Data 1	13	CEC		
7	TMDS Data 0+	14	Reserved (N.C. on device)		