



**THE DISPLAY CHOICE
OF PROFESSIONALS™**

PN-46D / PN-55H Digital Signage Display

User Manual

www.agneovo.com

Disclaimer

This company makes no representations or warranties, either expressed or implied, with respect to the contents of this document. This company reserves the right to revise this publication and to make changes from time to time in the contents thereof without obligation to notify any person of such revision or changes.

Copyright

Copyright 2013 by this company. All rights reserved. No part of this publication may be reproduced, transmitted, transcribed, stored in a retrieval system or translated into any language or computer language, in any form or by any means, electronic, mechanical, magnetic, optical, chemical, manual or otherwise, without the prior written permission of this company.

Table of Contents

Safety warnings and precautions	1
Important safety instructions	2
Notes on the LCD panel of this display	2
Safety notice for remote control	3
Battery safety notice	3
Notes on moving the display	4
Package contents	5
Setting up the display	6
Mounting the display	6
Parts of the display and their functions	8
Rear panel	8
Input/output terminals	10
Remote control.....	12
Using the remote control.....	13
Connection.....	14
Connecting audio/video signals	14
Connecting power	20
Basic operations.....	21
Turning the display on or off	21
Locking/unlocking the controls.....	21
Switching input signals.....	21
Adjusting audio volume level	21
Network connection	22
Connecting to a LAN.....	22
Controlling the display.....	22
The OSD (On-Screen Display) menu	23
OSD menu overview	23
Operations in the OSD menu	24
Picture menu	25
Sound menu.....	26
Screen menu.....	27
Setting menu	30
Product information	33
Specifications.....	33

Dimensions	35
Supported input signal resolution.....	37
Supported PBP input signal combination.....	39
Troubleshooting	40

Safety warnings and precautions



The lightning flash with arrowhead symbol, within an equilateral triangle, is intended to alert the user to the presence of uninsulated "dangerous voltage" within the product's enclosure that may be of sufficient magnitude to constitute a risk of electric shock to persons.



The exclamation point within an equilateral triangle is intended to alert the user to the presence of important operating and maintenance (servicing) instructions in the literature accompanying the appliance.

THIS EQUIPMENT MUST BE GROUNDED

To ensure safe operation, the three-pin plug must be inserted only into a standard three-pin power outlet which is effectively grounded through normal household wiring. Extension cords used with the equipment must have three cores and be correctly wired to provide connection to the ground. Wrongly wired extension cords are a major cause of fatalities.

The fact that the equipment operates satisfactorily does not imply that the power outlet is grounded or that the installation is completely safe. For your safety, if you are in any doubt about the effective grounding of the power outlet, please consult a qualified electrician.

- The mains plug of the power supply cord shall remain readily operable. The AC receptacle (mains socket outlet) shall be installed near the equipment and shall be easily accessible. To completely disconnect this equipment from the AC mains, disconnect the power cord plug from the AC receptacle.
- Do not place this display on an uneven, sloping or unstable surface (such as a trolley) where it may fall and cause damage to itself or others.
- Do not place this display near water, like a spa or pool, or in a position which will allow the splashing or spraying of water onto the display, like in front of an open window where rain water may enter.
- Do not install this display in a confined space without proper ventilation and air circulation, such as in a closed cabinet. Allow proper space around the display for dissipating heat inside. Do not block any openings and vents on the display. Overheating may result in hazards and electric shock.
- Installation of this display should only be performed by a qualified technician. Failure to install this display properly may cause injuries and damages to the personnels and the display itself. Check the installation regularly and maintain the display periodically to ensure the best working condition.
- Use only the accessories approved or recommended by the manufacturer to mount this display. Using wrong or unsuitable accessories may cause the display to fall and result in serious personal injuries. Make sure that the surface and fixing points are strong enough to sustain the weight of the display.
- To reduce the risk of electric shock, do not remove covers. No user serviceable parts inside. Refer servicing to qualified service personnel.
- To prevent personal injuries, mounting the display or installing desktop stands is required before use.

Important safety instructions

1. Read these instructions.
2. Keep these instructions.
3. Heed all warnings.
4. Follow all instructions.
5. Do not use this apparatus near water.
6. Clean only with dry cloth.
7. Do not block any ventilation openings. Install in accordance with the manufacturer's instructions.
8. Do not install near any heat sources such as radiators, heat registers, stoves, or other apparatus (including amplifiers) that produce heat.
9. Do not defeat the safety purpose of the polarized or grounding-type plug. A polarized plug has two blades with one wider than the other. A grounding-type plug has two blades and a third grounding prong. The wide blade or the third prong are provided for your safety. If the provided plug does not fit into your outlet, consult an electrician for replacement of the obsolete outlet.
10. Protect the power cord from being walked on or pinched particularly at plugs, convenience receptacles, and the point where they exit from the apparatus.
11. Only use attachments/accessories specified by the manufacturer.
12. Use only with the cart, stand, tripod, bracket, or table specified by the manufacturer, or sold with the apparatus. When a cart is used, use caution when moving the cart/apparatus combination to avoid injury from tip-over.
13. Unplug this apparatus during lightning storms or when unused for long periods of time.
14. Refer all servicing to qualified service personnel. Servicing is required when the apparatus has been damaged in any way, such as power-supply cord or plug is damaged, liquid has been spilled or objects have fallen into the apparatus, the apparatus has been exposed to rain or moisture, does not operate normally, or has been dropped.



Notes on the LCD panel of this display

- The Liquid Crystal Display (LCD) panel of this display has a very thin protective layer of glass which is liable to marking or scratching, and cracking if struck or pressured. The liquid crystal substrate is also liable to damage under excessive force or extreme temperatures. Please handle with care.
- The response time and brightness of the LCD panel may vary with the ambient temperature.
- Avoid placing the display in direct sun or where direct sun or spot lighting will shine onto the LCD panel, as the heat may damage the panel and the external casing of the display, and the bright light will make viewing the display more difficult than necessary.
- The LCD panel consists of individual pixels to display images and is manufactured according to the design specifications. While 99.9% of these pixels work normally, 0.01% of the pixels may remain constantly lit (in red, blue or green) or unlit. This is a technical limitation of the LCD technology and is not a defect.

- LCD screens, like plasma (PDP) and conventional CRT (Cathode Ray Tube) screens, are also susceptible to 'screen burn-in' or 'image retention' which can be found on the screen as visible fixed lines and shades. To avoid such damage to the screen, avoid displaying still images (like On-Screen Display menus, TV station logos, fixed/inactive text or icons) for more than two hours. Change the aspect ratio from time to time. Fill the entire screen with the image and eliminate the black bars whenever possible. Avoid displaying images in 4:3 aspect ratio over a long period of time, otherwise there may be visible burn marks on the screen as two vertical lines.
If display of a still image is required, it is recommended to enable **Anti-Burn-In** under the **Setting** and **Advanced** menu.
- Note: Under certain circumstances, condensation may occur on the inner side of the cover glass, it's a natural phenomenon and will not affect the operation of the display. This condensation will usually disappear after around 2 hours of normal operation.

Safety notice for remote control

- Do not put the remote control in the direct heat, humidity, and avoid fire.
- Do not drop the remote control.
- Do not expose the remote control to water or moisture. Failure to do so could result in malfunction.
- Confirm there is no object between the remote control and the remote sensor of the product.
- When the remote control will not be used for an extended period, remove the batteries.

Battery safety notice

The use of the wrong type of batteries may cause chemical leaks or explosion. Please note the following:

- Always ensure that the batteries are inserted with the positive and negative terminals in the correct direction as shown in the battery compartment.
- Different types of batteries have different characteristics. Do not mix different types.
- Do not mix old and new batteries. Mixing old and new batteries will shorten battery life or cause chemical leaks from the old batteries.
- When batteries fail to function, replace them immediately.
- Chemicals which leak from batteries may cause skin irritation. If any chemical matter seeps out of the batteries, wipe it up immediately using a dry cloth, and replace the batteries as soon as possible.
- Due to varying storage conditions, the battery life for the batteries included with your product may be shortened. Replace them within 3 months or as soon as you can after initial use.
- There may be local restrictions on the disposal or recycling of batteries. Consult your local regulations or waste disposal provider.

Notes on moving the display

The display has limited mechanical strength. To prevent the display from performance failure caused by line defects, front bezel bending, glass scratch/broken, light leakage, etc., it must be handled with care.

- Always move the display by at least two (2) adults.
- When you want to move the display, make sure the four (4) handles are held.
- When you want to place the display face down:
 - Prepare a flat and horizontal surface that is larger than the display and spread a thick protective sheet on it. (Fig. 1)
 - Lay down the display gently and horizontally. (Fig. 2)
- When you want to upturn the display:
 - Lift the display up horizontally by holding the four (4) handles. Do not lift the display against its corner. (Fig. 2)
 - Be careful not to scratch any parts of the display when upturning the display. (Fig. 3)
 - Stand the display vertically to make sure the its weight spread evenly on the surface. (Fig. 4)

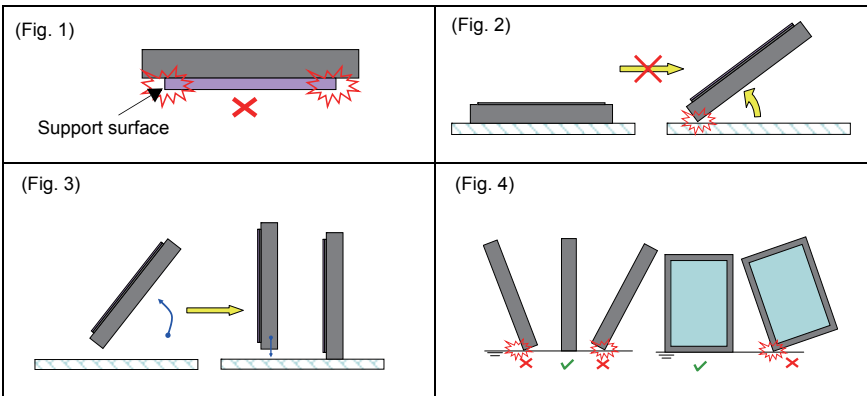

- Check the shock label on the outside of the product carton. The shock indicator on the label will turn red if the display/package is improperly handled.

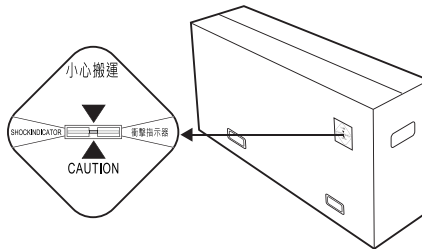

Package contents

Open the sales package and check the contents. If any item is missing or damaged, please contact your dealer immediately.



LCD display

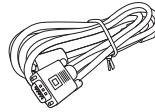

Power cord

D-Sub (15-pin)
cable

Remote control

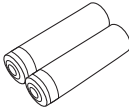

AAA batteries

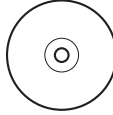

User manual CD

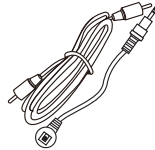

IR cables

- Note**
- The type of power cord supplied may differ from that illustrated depending on your region of purchase.
 - Before discarding the package, check that you haven't left any accessories inside the box.
 - Dispose of packaging materials wisely. You can recycle the cardboard carton. Consider storing the package (if possible) for future transport of the display.
 - Do not leave plastic bags within reach of young children or babies.

Setting up the display

Mounting the display

You can install the display on a vertical surface with a suitable wall mounting bracket or on a horizontal surface with the optional desktop stands. Please pay attention to the following notes during installation:

- This display should be installed by at least two adult persons. Attempting to install this display by only one person may result in danger and injuries.
- Refer the installation to qualified technicians. Improper installation may cause the display to fall or malfunction.

Installing the display on a wall

1. Place a clean, dry and lint-free cloth on a flat, horizontal and object-free surface. Make sure that the size of the cloth is larger than the display.
2. Gently lay the display on the cloth with the LCD screen facing down.
3. Remove the desktop stands from the display if installed.
4. Identify the wall mounting screw holes on the back of the display as shown in the illustration.

PN-46D

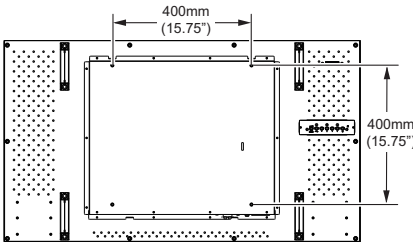

PN-55H

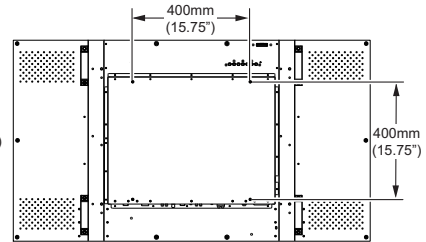

*Screw type: M6

5. Install the wall mounting bracket on the display and attach the display to the wall according to the mounting bracket's instructions. The length of the screw should exceed the thickness of the wall mounting bracket by at least 10 mm. Make sure that all screws are tightened and secured properly. (Recommended torque: 470 - 635N•cm). The mounting means should be strong enough to bear the weight of the display.

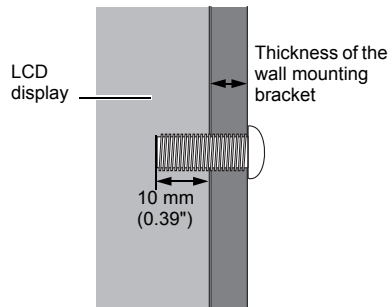

- Note**
- To maintain proper ventilation, keep at least 10 mm of clear space from the back cover of the display to the wall.
 - Please consult a professional technician for wall mount installations. The manufacturer accepts no liability for installations not performed by a professional technician.

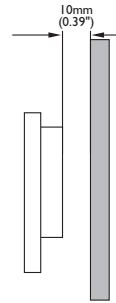

- The AC IN/OUT socket should be on top of connectors when rotating your display.

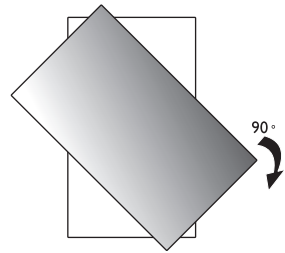

Video Wall Installation Precautions:

- Install the mounting bracket to the wall following the instruction manual of the wall mounting bracket. Make sure the mounting bracket is vertically and horizontally placed.
- Mount and fasten the display on the mounting bracket or stand by tightening the screws through the respective holes with a screwdriver. Do not place one display directly on another as the stacked LCD screens may be damaged by the weight.
- Start your video wall from the bottom left or bottom right. Finish one row and then move up to finish the next row. Once a display has been installed, check the horizontal and vertical level immediately using a professional measuring tool.
- Place your displays as close to each other as possible but an appropriate space of at least 0.5 mm should be kept.

Important:

During video wall installation, you might want to place the displays as close to each other as possible. Note the LCD screens may be damaged through the direct transfer of weight if an appropriate distance is not kept between displays.

Parts of the display and their functions

Rear panel

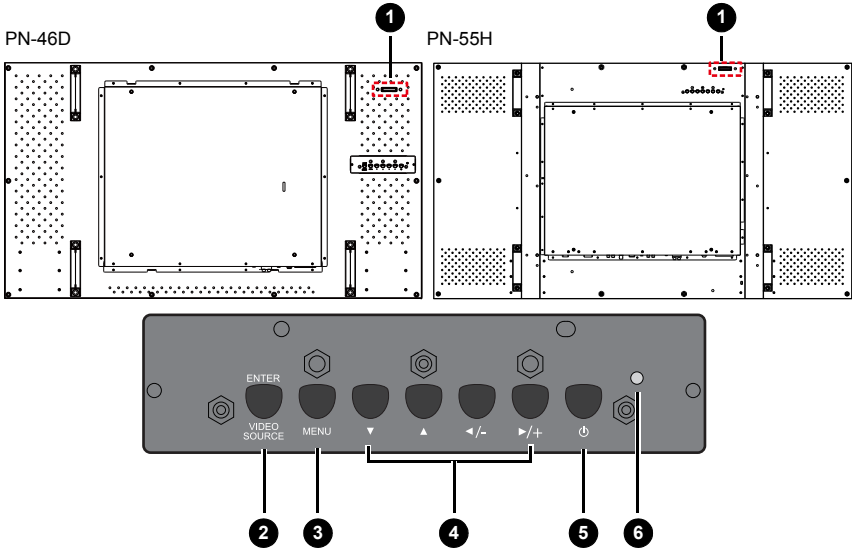

No.	Name	Description
1	Remote control sensor / Ambient light sensor / Power indicator	<ul style="list-style-type: none"> Receives command signals from the remote control. Detects ambient lighting conditions around the display and adjusts screen brightness automatically when the Ambient Light Sensor function is activated. Indicates the operating status of the display: <ul style="list-style-type: none"> Lights up green when the power is turned on. Lights up red when the display is turned off. Lights up red when the display is in Power Save High mode. Flashes red when the display is in Power Save Low mode. Off when the main power is turned off.
2	ENTER/VIDEO SOURCE button	<ul style="list-style-type: none"> Selects a video source. Confirms your selection or enters a submenu in the On-Screen Display (OSD) menu.
3	MENU button	Opens or closes the OSD menu.
4	▼, ▲, ◀/-, ▶/+	<ul style="list-style-type: none"> Scrolls through settings and options in the OSD menu. ◀ /-, ▶ /+: Hot keys for audio volume adjustment.
5	Power button	Turns the display on or off.

6 Power indicator

Indicates the power status of the display:

- Lights up green when the power is turned on.
 - Lights up red when the display is turned off.
 - Lights up red when the display is in **Power Save High** mode.
 - Flashes red when the display is in **Power Save Low** mode.
 - Off when the main power is turned off.
-

Input/output terminals

PN-46D

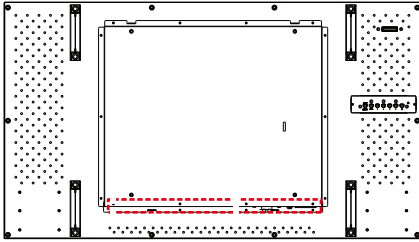

PN-55H

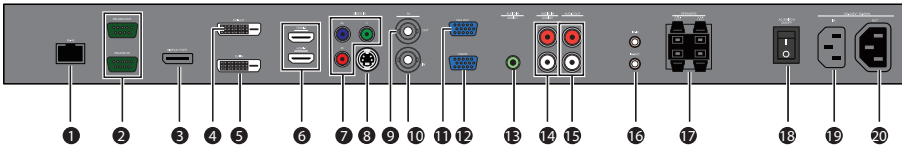
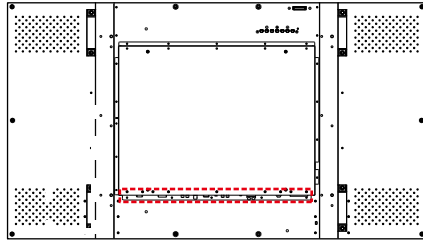

No.	Name	Description
1	RJ-45	Connects to the RJ-45 port on your Ethernet or router.
2	RS232C IN/OUT	For external control and multi-display operation. <ul style="list-style-type: none"> • RS232C IN: receives control signals from a computer or another display. • RS232C OUT: outputs control signals from the RS232C IN input to another display.
3	DISPLAY PORT	Connects to a DisplayPort compatible device.
4	DVI-OUT	Outputs DVI signals from the DVI-IN input to another display.
5	DVI-IN	Receives DVI signals from an external device (such as a computer).
6	HDMI-1/HDMI-2	Receives HDMI signals from an external device (such as a Blu-ray disc player).
7	VIDEO IN (YPbPr)	Receives component video (YPbPr) signals from an external device (such as a DVD player, HDTV device or Laser disc player).
8	VIDEO IN (S-VIDEO)	Receives S-Video signals from an external device (such as a VCR or DVD player).
9	AV OUT	Outputs composite video signals from the AV IN input to another display.
10	AV IN	Receives composite video signals from an external device (such as a VCR or DVD player).
11	VGA OUT	Outputs analog RGB signals from the VGA IN input to another display.

12	VGA IN	Receives analog RGB signals from an external device (such as a computer).
13	AUDIO IN (AUDIO1)	Receives audio signals from an external device (such as a computer).
14	AUDIO IN (AUDIO2)	Receives audio signals from an external device (such as a VCR or DVD player).
15	AUDIO OUT (R/L)	Outputs audio signals to an external device.
16	IR-IN/IR-OUT	<ul style="list-style-type: none">• IR-IN: For use with an IR Extender - to ensure better responsiveness from the remote control.• IR-OUT: Outputs the IR signal from the IR-IN input to another display.
17	SPEAKERS (R/L)	Outputs audio signals to external speakers.
18	AC SWITCH ON/OFF	Turns on or off the main power.
19	AC IN	Connects to a power outlet via the supplied power cord.
20	AC OUT	Relays the AC power from the AC IN jack to another display.

Remote control

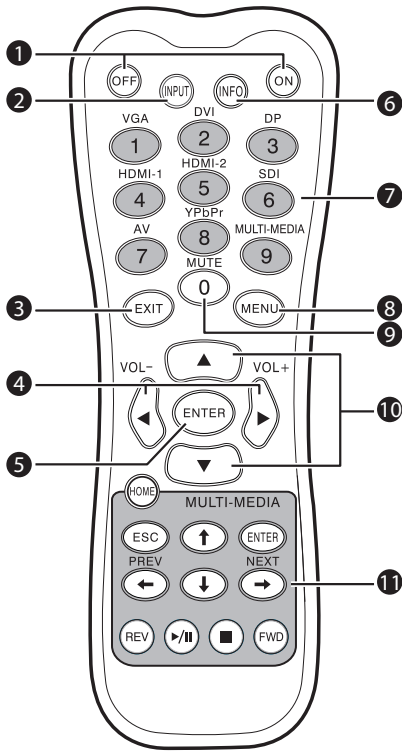

1 ON/OFF

Turns the display on or off.

2 INPUT

Selects an input source.

3 EXIT

Returns to a previous menu or closes the OSD menu.

4 ◀ / VOL- / ▶ / VOL+

- Scrolls through settings and options in the OSD menu.
- Turns down/up the volume.

5 ENTER

Confirms your selection or save changes.

6 INFO

Shows the current input source and resolution.

7 Numeric buttons (1-9) / Input source buttons

- Performs as numeric buttons when the OSD menu is on.
- Performs as input source buttons when the OSD menu is off.

Note: SDI and MULTI-MEDIA functions are not available with this display.

8 MENU

Opens or closes the OSD menu.

9 Numeric button (0)/MUTE

- Performs as a numeric button when the OSD menu is on.
- Turns on or off the mute function.

10 ▲ / ▼

Scrolls through settings and options in the OSD menu.

11 MULTI-MEDIA buttons

These functions are not available with the display.

Using the remote control

Installing remote control batteries

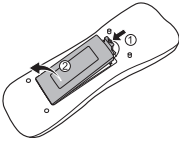

1. Open the remote control battery compartment cover.

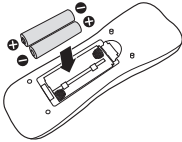

2. Insert the supplied batteries ensuring that the positive and negative marked battery terminals match the (+) and (-) marks in the battery compartment.

Note: The supplied batteries are provided for your convenience so that you can operate the display straight away. You should replace them as soon as possible.

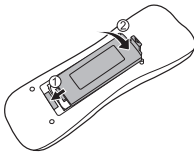

3. Refit the battery compartment cover.

Remote control usage tips

- Point and aim the top front of the remote control directly at the display's remote control sensor window when you press the buttons.
- Do not let the remote control become wet or place it in humid environments (like bathrooms).
- If the display's remote control sensor window is exposed to direct sunlight or strong light, the remote control may not operate properly. In this situation, change the light source, readjust the angle of the display or operate the remote control from a location closer to display's remote control sensor window.

PN-46D

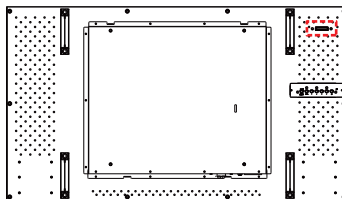

PN-55H

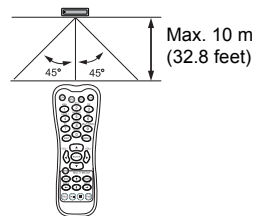
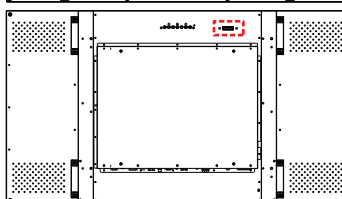

Connection

Connecting audio/video signals

Pay attention to the following notes when you connect cables:

- Please turn off all devices.
- Familiarize yourself with the audio/video ports on the display and the devices you want to use. Be aware that incorrect connections may adversely affect picture quality.
- Do not remove cables from the ports by pulling the cable itself. Always grasp and pull the connectors at the end of the cable.
- Ensure that all cables are fully inserted and firmly seated.

Connecting the VGA input

1. Connect the **VGA IN** jack on the display to the VGA output jack on a computer using a D-Sub (15-pin) cable.
2. Connect the computer's audio output jack to the **AUDIO IN (AUDIO1)** jack on the display using a suitable audio cable.
3. To view images from this input, press the **VGA** button on the remote control. To select an appropriate audio source, see Audio Source on page 26 for details.

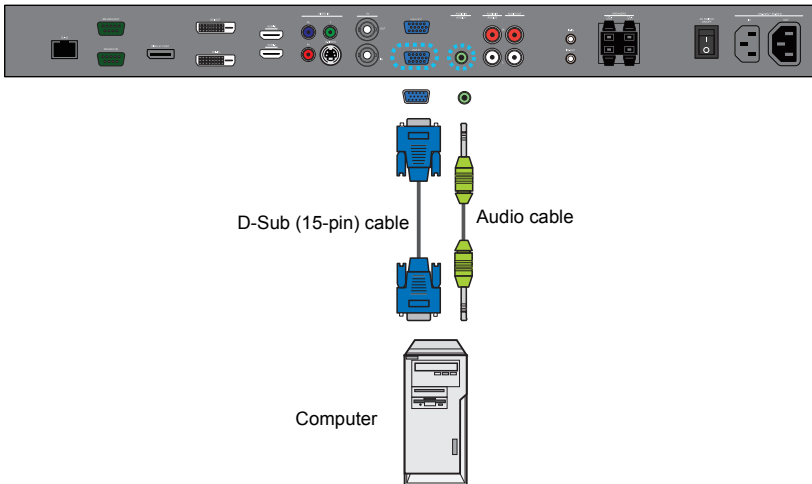

Note: The audio cable is not supplied and should be purchased separately.

Connecting the digital input

1. Connect the **DVI-IN** jack on the display to the DVI-D output jack on a computer using a DVI-D cable. If the computer has a DisplayPort/HDMI output jack, connect the computer's DisplayPort/HDMI output jack to the **DISPLAY PORT/HDMI-1/HDMI-2** input jack on the display using a DisplayPort/HDMI cable or a DVI-D to HDMI conversion cable.
2. If needed, connect the computer's audio output jack to the **AUDIO IN (AUDIO1)** jack on the display using a suitable audio cable.
3. To view video image from this input, press the **DVI** or **DP/HDMI-1/HDMI-2** button on the remote control. To select an appropriate audio source, see Audio Source on page 26 for details.

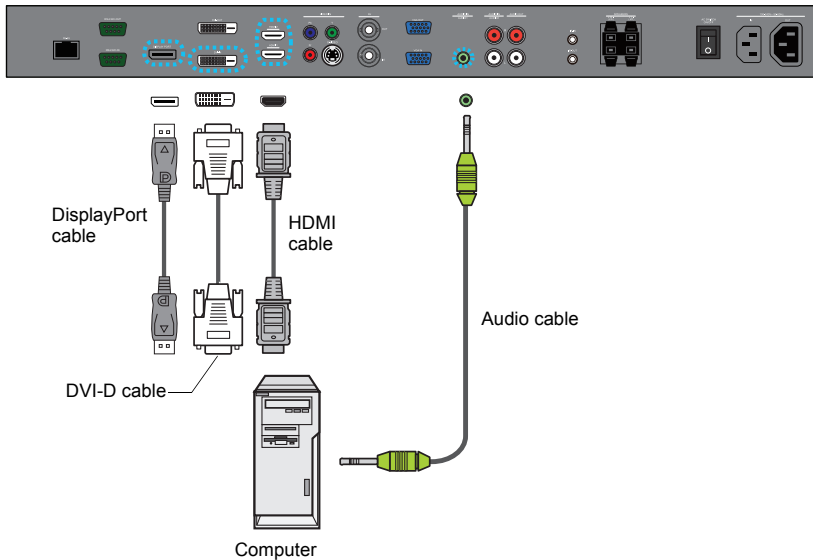

Note: The cables are not supplied and should be purchased separately.

Connecting the YPbPr component video input

1. Connect the **VIDEO IN (YPbPr)** jacks on the display to the component output jacks on an A/V device (such as a VCR or DVD player) using a component video cable.
2. Connect the DVD player's audio output jacks to the **AUDIO IN (AUDIO2)** jacks on the display using a suitable audio cable.
3. To view video image from this input, press the **YPbPr** button on the remote control. To select an appropriate audio source, see Audio Source on page 26 for details.

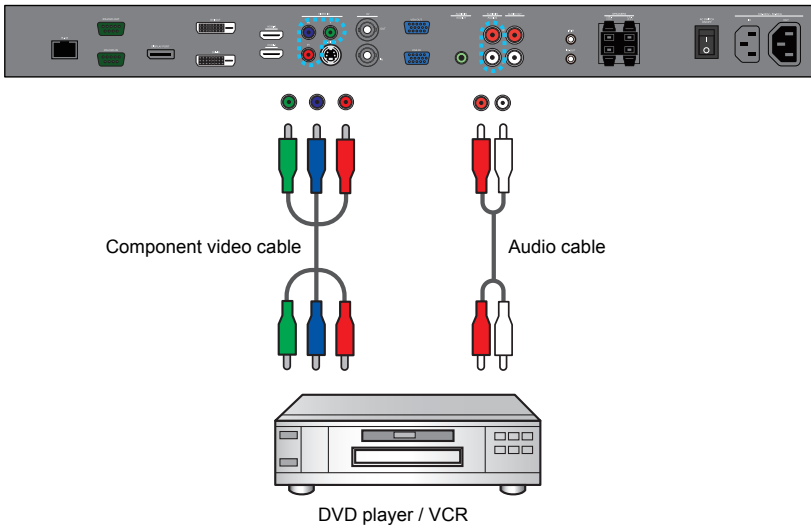

Note: The cables are not supplied and should be purchased separately.

Connecting the AV and S-Video inputs

1. Connect the **VIDEO IN (S-VIDEO)** or **AV IN** jack on the display to the output jack on an A/V device (such as a VCR) using an appropriate video cable.
2. Connect the VCR's audio output jacks to the **AUDIO IN** jacks on the display using a suitable audio cable.
3. To view video image from this input, press the **AV** button on the remote control for the AV signal, or press the **INPUT** button repeatedly for the S-Video signal. To select an appropriate audio source, see Audio Source on page 26 for details.

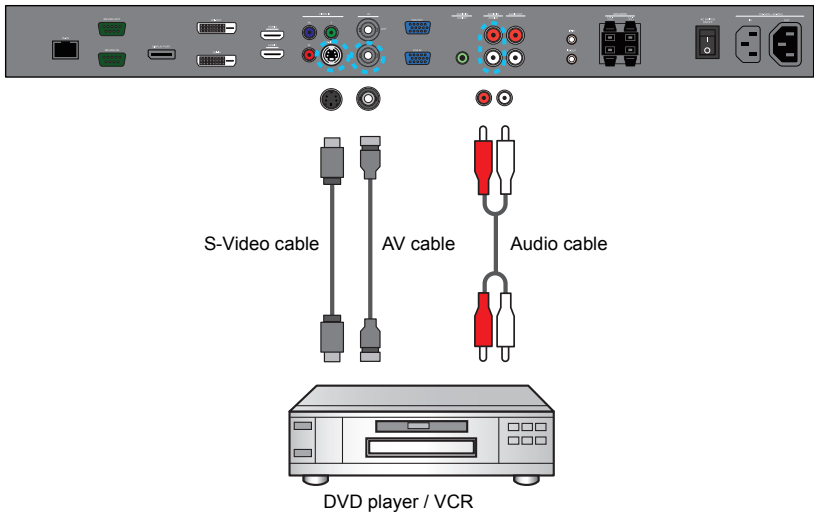

Note: The cables are not supplied and should be purchased separately.

Connecting multiple displays

You can connect multiple displays serially (daisy chain) to a computer for management. The number of displays you can connect serially depends on the resolution of the input signal you use.

Additional display

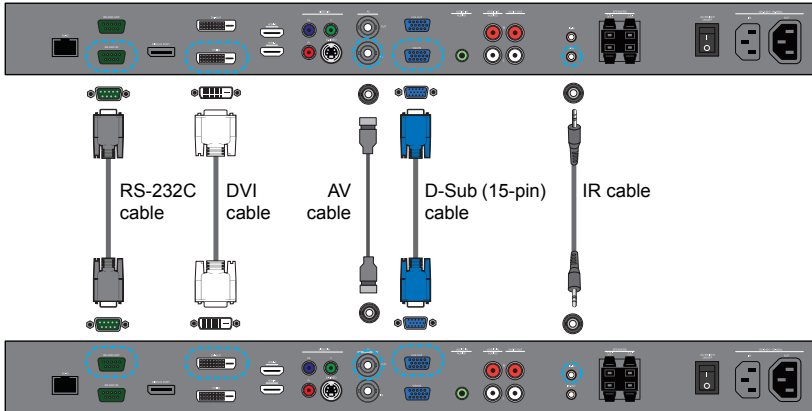

The first display

- Note**
- This RS-232C daisy chain application requires an RS-232C port equipped computer.
 - Use RS-232C serial null modem cables for daisy chain application.
 - Avoid using HDCP source for daisy chain application

Connecting power

1. Plug one end of the power cord into the **AC IN** jack on the display and the other end into an appropriate power outlet (if the outlet is switched, turn on the switch).
2. Press the power switch to turn on the main power.

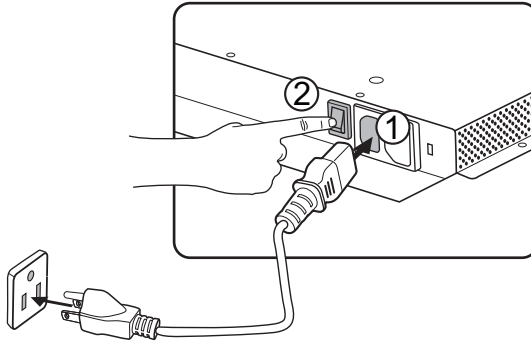

- Note**
- The supplied power cord is suitable for use with 110-240V AC power only.
 - The power cord and outlet illustrated may differ from the ones used in your region.
 - Only use an appropriate power cord for your region. Never use a power cord which appears damaged or frayed, or change the plug type on the power cord.
 - Be aware of the power loading when you use extension cords or multiple outlet power boards.
 - There are no user serviceable parts in this display. Never unscrew or remove any covers. There are dangerous voltages inside the display. Turn off the power and unplug the power cord if you intend to move the display.

Basic operations

Turning the display on or off



To turn on or off the display, press the power button on the display's control panel or on the remote control.



- **Note** • The display's standby mode still consumes power. To completely cut off power supply, set the power switch to the off position or disconnect the power cord from the power outlet.
- The display follows the VESA approved DPM Power Management function. The power management function is an energy saving feature that automatically reduces the display's power consumption when the keyboard or the mouse has not been used for a fixed period.

Locking/unlocking the controls

You can lock/unlock the control panel to prevent unwanted or accidental operations.

• Control panel buttons

To lock/unlock the control panel buttons, press and hold ◀ /- and ▶ /+ on the control panel simultaneously for 5 seconds. Once locked, the control panel buttons do not function unless unlocked.

• Remote control functions

To lock/unlock the remote control functions, press and hold **MENU** and ◀ /- on the control panel for 5 seconds. Once locked, the display does not respond to any remote control operations unless unlocked.

To lock/unlock both the control panel and remote control buttons, press ▼ for 5 seconds, and then **ENTER** on the remote control. Once locked, the control panel and remote control buttons do not function unless unlocked.

Switching input signals

Press the **INPUT** button or those signal selection buttons on the remote control or the **INPUT** button on the control panel to select an input signal.

Adjusting audio volume level

Press ◀ /- or ▶ /+ on the control panel or **VOL+/VOL-** on the remote control to adjust the volume.

Network connection

Connecting to a LAN

To set the display to connect to a local area network:

1. Connect a RJ45 cable to the corresponding ports on the display and your LAN switch or router.
2. Enter the OSD menu **Setting > Control Setting**. Select **LAN**.
3. Enter the next OSD menu **Setting > Network Settings**.
If you are in a DHCP environment, select **DHCP > Execute** and press **ENTER**. Once done, the **IP Address**, **Subnet Mask**, **Default Gateway**, **Primary DNS**, and **Secondary DNS** settings will be displayed.
If you are not in a DHCP environment, select **Manual > Execute** and press **ENTER**. Contact your ITS administrator for information on the **IP Address**, **Subnet Mask**, **Default Gateway**, **Primary DNS**, and **Secondary DNS** settings and enter it accordingly.
4. To save the settings and return to the previous menu, highlight **Execute** and press **ENTER** on the remote control.

Controlling the display

Once you have the correct IP address for your display and the display is on or in standby mode, you can use any computer that is on the same local area network to control the display.

- Note** • You cannot control the display via the RS-232C connector when LAN control is in use.
• It is recommended that you use Internet Explorer versions 7.0 or higher browser.

1. Enter the IP address of the display in the address bar of your Internet browser and press Enter.
2. The setting page appears.
 - **Information**: Shows information of the display. It is for information only. There are no items that can be set.
 - **Picture & Sound**: Provides options for picture and sound adjustments.
 - **Screen**: Provides options related to display adjustments.
 - **Setting**: Provides options for advanced display adjustments.
 - **Mail Report**: Provides options for setting up email accounts to receive status or error reports sent from the display.
 - **Network**: Provides options for manually setting the display's IP address or obtaining an IP address from a DHCP server.

Note: Make sure the **Setting > Control Setting** menu is set to **LAN**, and the **Setting > Power Save** menu is set to **Low** or **Off** if you would like to turn on the display from a web page.







The OSD (On-Screen Display) menu

OSD menu overview

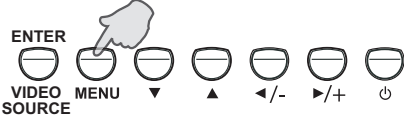
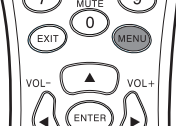
Menu name	Options/functions	See page
Picture	<ul style="list-style-type: none"> • Picture Mode • Backlight • Contrast • Brightness • Chroma • Phase • Sharpness • Color Temp. • Noise Reduction • Film Mode • Reset 	25
Sound	<ul style="list-style-type: none"> • Sound Mode • Treble • Bass • Balance • Surround • Speaker • Audio Source • Reset 	26
Screen	<ul style="list-style-type: none"> • PAP Setting • Display Wall • Aspect • Adjust Screen • Freeze 	27
Setting	<ul style="list-style-type: none"> • Language • Schedule • Power Save • Control Setting • Network Settings • Set Monitor ID • HDMI Control • Advanced • Information • All Reset 	30

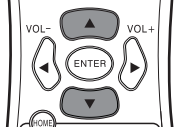
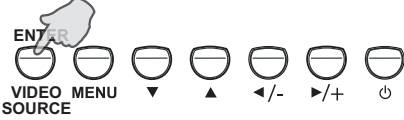
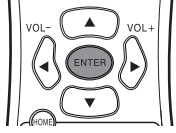
Note: Some options are only available when a certain input signal source is selected.

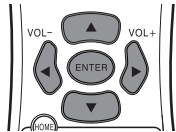
Operations in the OSD menu

Using the control panel buttons	Using the remote control
<p>1. Press MENU to open the OSD menu.</p>  <p>ENTER VIDEO SOURCE</p> <p>MENU ▼ ▲ ◀/◻ ▶/+ ⏻</p>	<p>1. Press MENU to open the OSD menu.</p>  <p>MUTE 0</p> <p>EXIT MENU</p> <p>VOL- ▲ VOL+</p> <p>◀ ENTER ▶</p>
<p>2. In the OSD menu, press ▲ or ▼ to select an item.</p>  <p>ENTER VIDEO SOURCE</p> <p>MENU ▼ ▲ ◀/◻ ▶/+ ⏻</p>	<p>2. Press ▲ or ▼ to select an item.</p>  <p>VOL- ▲ VOL+</p> <p>◀ ENTER ▶</p> <p>POWER ▼</p>
<p>3. Press ENTER/VIDEO SOURCE to confirm selections.</p>  <p>ENTER VIDEO SOURCE</p> <p>MENU ▼ ▲ ◀/◻ ▶/+ ⏻</p>	<p>3. Press ENTER to confirm selections.</p>  <p>VOL- ▲ VOL+</p> <p>◀ ENTER ▶</p> <p>POWER ▼</p>
<p>4. Press ▲ or ▼ to select a feature and press ◀ or ▶ to adjust settings. Press ENTER/VIDEO SOURCE to save changes.</p>  <p>ENTER VIDEO SOURCE</p> <p>MENU ▼ ▲ ◀/◻ ▶/+ ⏻</p>	<p>4. Press ▲ and ▼ to select a feature and press ◀ or ▶ to adjust settings. Press ENTER to confirm changes.</p>  <p>VOL- ▲ VOL+</p> <p>◀ ENTER ▶</p> <p>POWER ▼</p>
<p>5. Press MENU to close the OSD menu.</p>  <p>ENTER VIDEO SOURCE</p> <p>MENU ▼ ▲ ◀/◻ ▶/+ ⏻</p>	<p>5. Press MENU to close the OSD menu.</p>  <p>MUTE 0</p> <p>EXIT MENU</p> <p>VOL- ▲ VOL+</p> <p>◀ ENTER ▶</p>

Picture menu

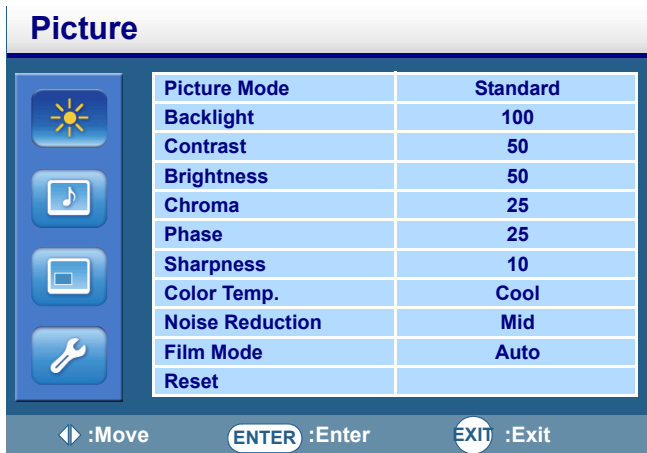

Name	Description
Picture Mode	Sets the display mode.
Backlight	Adjusts the backlight intensity for the screen. Note: This feature is not available if the Ambient Light Sensor or Adaptive Contrast function is set to On .
Contrast	Adjusts the image contrast.
Brightness	Adjusts the image brightness.
Chroma	Adjusts the color intensity of the image.
Phase	Adjusts the color tint of the image.
Sharpness	Adjusts the image sharpness.
Color Temp.	Adjusts the color temperature.
Noise Reduction	Reduces electrical image noise caused by different media players.
Film Mode	Optimizes the screen display automatically by detecting picture content and applying a reverse 3-2 or 2-2 pull-down process. The picture will be clearer and more natural. Note <ul style="list-style-type: none"> • This function is not available when displaying Picture and Picture (PAP). • This function may not be correctly processed depending on the input signal.
Reset	Resets all settings in the Picture menu.

Sound menu

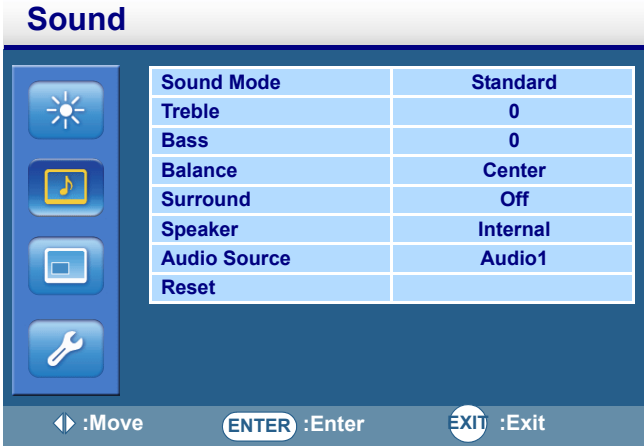

Name	Description
Sound Mode	Adjusts the sound output from the speakers. Dynamic: Enhances treble and bass. Standard: Flat settings. Custom: Recalls the customized settings.
Treble	Adjusts the audio treble.
Bass	Adjusts the audio bass.
Balance	Adjusts the audio balance.
Surround	Turns the surround mode on or off.
Speaker	Sets the audio source. Line-Out: Selects the audio output source from AUDIO OUT (R/L) on the rear connector panel. External: Selects the audio output source from SPEAKERS (R/L) on the rear connector panel. Internal: Select the audio output source from the internal speakers.
Audio Source	Sets the audio input source. 
Reset	Resets all settings in the Sound menu.

Screen menu

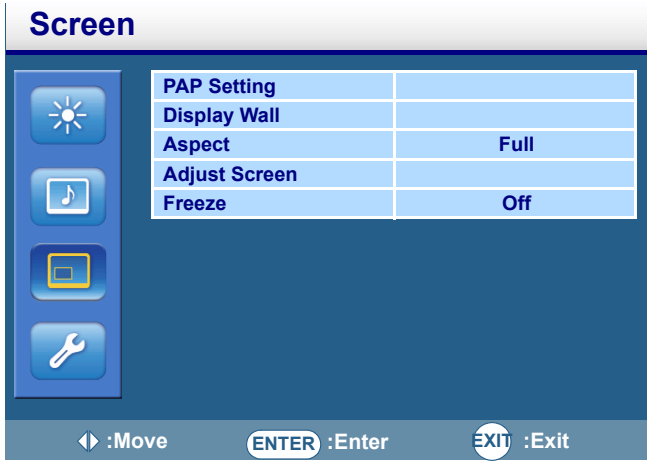

Name	Description
PAP Setting (Picture and Picture)	<ul style="list-style-type: none"> • PAP: Turns on or off the PIP (Picture in Picture) and PBP (Picture by Picture) functions. • Active Picture: For the PIP, selects the main or sub picture to operate. For the PBP, selects the left or right picture to operate. Swaps the main/sub or left/right pictures. • Picture Size: Changes the size of the sub picture. • Picture Position: (PIP only) Changes the position of the sub picture. <p>Note</p> <ul style="list-style-type: none"> • PAP is not available for all signal source combinations. See Supported PBP input signal combination on page 39 for more information on supported combinations. • In PAP mode, only sound from the active picture will be available.
Display Wall	<ul style="list-style-type: none"> • H. Monitors/V. Monitors: Sets the number of displays used in the horizontal/vertical direction. • H. Position/V. Position: Sets the horizontal/vertical position of the display wall matrix. • Frame Comp.: Adjusts images near the display edges for optimal demonstration across the display wall. • LED: Turns the power indicator on the display on or off. • Power On Delay: Choose to enable or disable a sequence in turning on the screen matrix. If enabled, the display will turn on with a maximum of 10-second delay.
Aspect	<p>Sets the picture's aspect ratio.</p> <ul style="list-style-type: none"> • Wide Zoom: Enlarges to fill screen with minimum distortion. • Zoom: Enlarges the picture, keeping the same aspect ratio.

Aspect
(continued)

- **Full**: Enlarges the picture horizontally to fill the screen when the picture source is 4:3 (Standard definition). When the picture source is 16:9 (High definition), it displays in the same 16:9 aspect ratio.
- **4:3**: Displays all picture source in 4:3 aspect ratio.
- **Full 1**: Enlarges the picture to fill the screen in the vertical direction, keeping the same aspect ratio. A black frame may appear around the picture.
- **Full 2**: Enlarges the picture to fill the screen.
- **Real**: Displays the picture in its original number of dots.

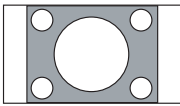
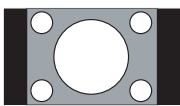
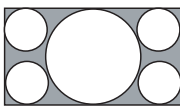
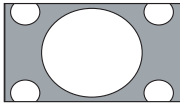
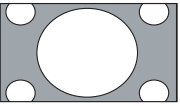
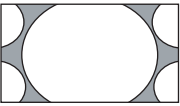
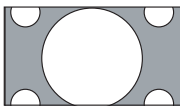
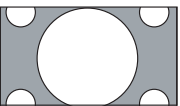
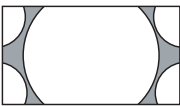
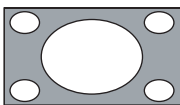
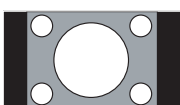
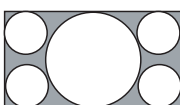
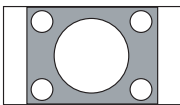
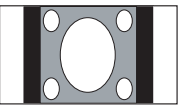
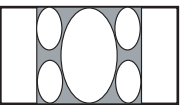
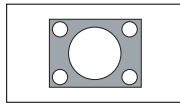
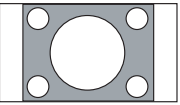
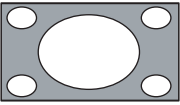
For video signal inputs		
4:3 original source	16:9 Original source	
		
Wide Zoom	Wide Zoom	
		
Zoom	Zoom	
		
Full	Full	
		
4:3	4:3	
		
For PC signal input		
Real	Full 1	Full 2
		

Adjust Screen	<ul style="list-style-type: none">• Auto Adjustment: Sets whether to optimize image display for each VGA input.• Phase: Adjusts the phase of the VGA input image.• Clock Frequency: Adjusts the clock frequency of the VGA input image.• H. Position: Adjusts the horizontal position of the VGA input image.• V. Position: Adjusts the vertical position of the VGA input image.
Freeze	Freezes the displayed image.

Setting menu

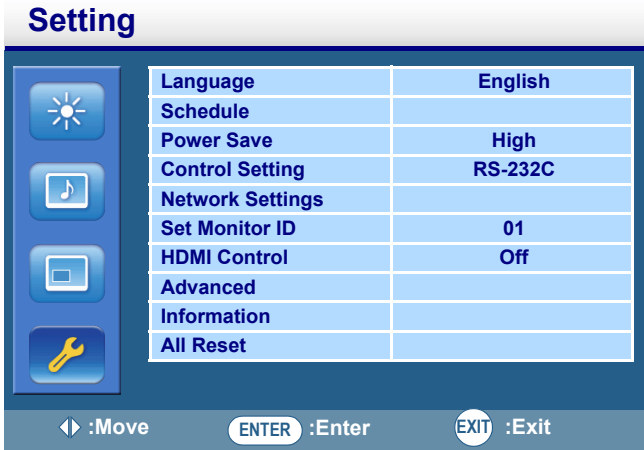

Name	Description
Language	Sets your preferred language for the OSD menu.
Schedule	<ul style="list-style-type: none"> • Date and Time: Sets the current date and time. • Clock Display: Sets whether to show the current time which was set. • Input: Sets an input source to display when the display is automatically turned on next time. • On/Off Timer: Sets when to turn on or off the display. <p>Note</p> <ul style="list-style-type: none"> • Set the current time before you set the On/Off Timer. • When schedule settings overlap, the Everyday setting takes priority over other weekly settings.
Power Save	<p>Sets the display to enter the power saving mode when there is no signal detected.</p> <ul style="list-style-type: none"> • Low: All source can enter the power saving mode and wake up the display. • High: All source can enter the power saving mode, but only a VGA signal can wake up the display or you have to press the power button to wake up the display when other source is connected. • Off: If no source is detected, the backlight will continue on. <p>Note</p> <ul style="list-style-type: none"> • RS-232C can bring any mode out of the power saving status. • On Power Save setting High, the LAN function is not available if the monitor enters Power Save, or DC off mode.

Control Setting	<ul style="list-style-type: none">• RS-232C/LAN: Sets a terminal to control the display.• IR Passthrough: Select it when multiple displays are connected via RS-232C cables.<ul style="list-style-type: none">- Primary: Designate the display as the primary unit for remote control operation. Only this display will be operated by the remote control.- Secondary: Designate the display as the secondary unit. The display can not be operated by the remote control, and will only receive the control signal from the primary display via the RS-232 connection. <p>Note: To go back to the default setting (RS-232C) for Control Setting, press INFO on the remote control for 5 seconds.</p>
Network Settings	See Network connection on page 22 for details.
Set Monitor ID	Assigns an ID number for the current display when multiple displays are connected. Note: For use when under the RS-232C control mode.
HDMI Control	Uses the HDMI CEC (Consumer Electronics Control) industry standard protocol to share functionality between connected devices and the display. To transfer system commands, you need to use an HDMI cable to connect the display to a device equipped with HDMI CEC. Select On in this menu and you can operate the main functionalities on your display and the connected device with one remote control.

<p>Advanced</p>	<ul style="list-style-type: none"> • Auto Search: Automatically detects available input sources. • Auto Adjustment: Automatically optimizes image display for the VGA input. • Overscan: Turns the overscan function on or off. • RGB Signal: Sets the type of signal for a piece of video equipment or PC connected to the HDMI of the display • Anti-Burn-In: This function helps to prevent image retention (burn marks) on the screen. When turned on, you can select a mode to perform and a time interval to activate the function. <ul style="list-style-type: none"> - Mode A (ps: frame): Executes fast. - Mode B (ps: line): Slower but more precise than mode A. - Mode C (ps: dot): Slowest but the most precise mode. • OSD Rotation: Adjusts the OSD rotation. <p>Note: See product specifications for models recommended for portrait orientation. Landscape only models operated in portrait mode may result in premature failure and will not be covered under the warranty.</p> <ul style="list-style-type: none"> • OSD Info Box: When turned On, switching signal inputs, or changing timing, the display will show the current input source and resolution onscreen. Select Off to show the information box onscreen only when you press INFO on the remote control. • Adaptive Contrast: Turns the Adaptive Contrast function on or off. This feature enhances image contrast for dark scenes. <p>Note: This feature is not available if the Ambient Light Sensor function is set to On.</p> <ul style="list-style-type: none"> • Ambient Light Sensor: When turned On, the image brightness will adjust automatically as the ambient lighting conditions change. • IR Out: To operate multiple units with one IR remote control, select On. Point the remote control to the first display which IR OUT port connects to the second display's IR IN port, and the second display's IR OUT port connects to the third display's IR IN port, and so on. See Connecting multiple displays on page 19 for connection diagram.
<p>Information</p>	<p>Displays the following information of your display.</p> <ul style="list-style-type: none"> • Date • Model Name • Serial Number • Operating Time • Software Version • LAN Version • IP Address
<p>All Reset</p>	<p>Returns all settings to factory default values.</p>

Product information

Specifications

Model		PN-46D	PN-55H
Item		Specifications	
LCD panel	Backlight	D-LED	
	Panel size	46"	55"
	Pixel pitch (mm)	0.53025	0.630
	Native resolution (pixels)	1920 x 1080	
	Brightness (cd/m ²) (typical)	450	800
	Contrast (typical)	4000:1	1400:1
	Response time (ms) (typical)	6.5	10
	Color depth	1.07 billion	
Input	Computer	VGA (D-Sub 15-pin)	
	Video	DVI (DVI-D), Composite Video (BNC jack), S-Video, YPbPr (RCA jacks), HDMI x 2, DisplayPort	
	Audio	L/R (RCA jacks), Line-in (3.5 mm jack)	
	IR	IR In (Jack Audio Green/Blue D3.6 ST)	
	Control	RS-232C (D-Sub 9-pin), RJ45 (Jack RJ45 W/LED)	
Output	Computer	VGA (D-Sub 15-pin)	
	Video	DVI (DVI-D), Composite Video (BNC jack)	
	Speaker	External speaker jack (12W+12W, 8 Ohms)	
	Audio	L/R (RCA jacks)	
	IR	IR Out (Audio Jack Green/Blue D3.6 ST)	
	Control	RS-232C (D-Sub 9-pin)	
Audio	Audio W (Amp)	12W x 2	
	Internal speaker	12W x 2	
Power	Supply	100 - 240V AC, 50/60 Hz	
	Consumption max.	155W	345W
	Consumption standby	< 0.5 W	
Environment	Operating temperature	0 - 40°C, 32 - 104°F	
	Operating humidity	10 - 90% (without condensation)	
	Storage temperature	-20 - 60°C, 4 - 140°F	
	Storage humidity	10 - 90% (without condensation)	
	Display orientation	Landscape/Portrait	

Mechanical	Weight (kg), approximate value	25	32
	Dimensions (W x H x D) (mm)	1023.68 x 578.27 x 111.8	1215.2 x 686 x 115.25

Note: Specifications and functions are subject to change without notice.

Dimensions

PN-46D

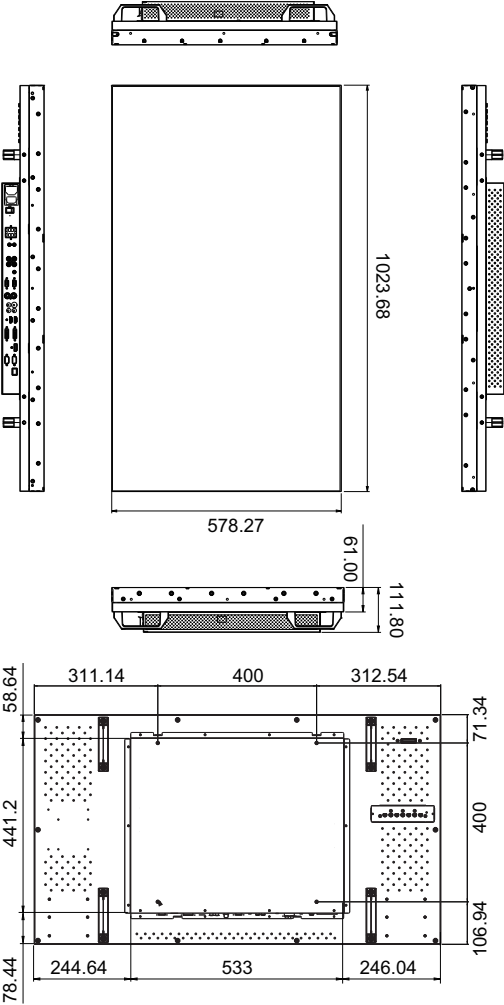

Unit: mm

PN-55H

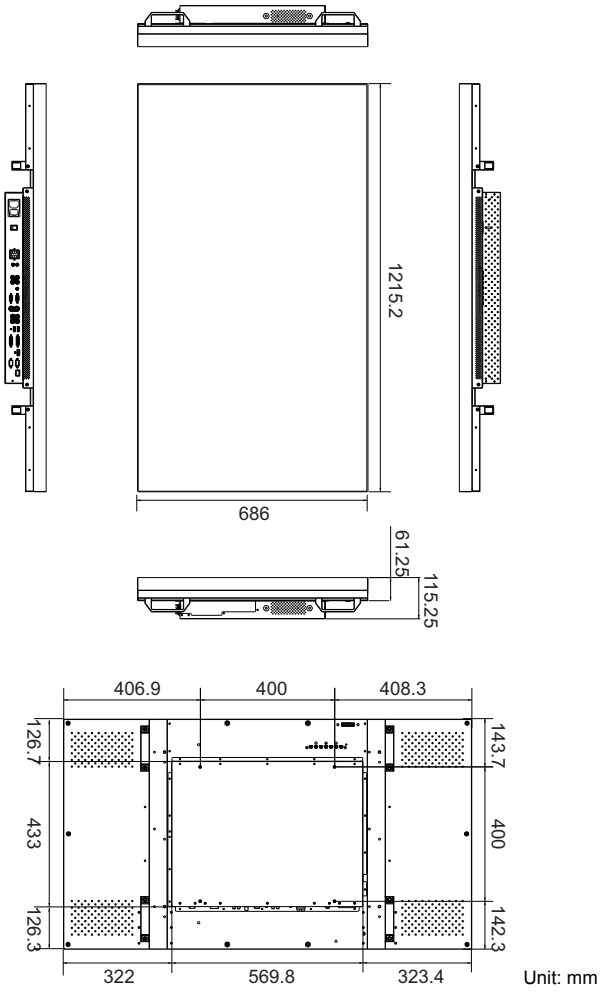

Supported input signal resolution

Resolution	Input source						
	AV	S-Video	YPbPr	VGA	HDMI	DVI	Display Port
640 x 480 @ 60Hz				○	○	○	○
640 x 480 @ 72Hz				○	○	○	○
640 x 480 @ 75Hz				○	○	○	○
720 x 400 @ 70Hz				○	○	○	○
800 x 600 @ 60Hz				○	○	○	○
800 x 600 @ 75Hz				○	○	○	○
1024 x 768 @ 60Hz				○	○	○	○
1024 x 768 @ 75Hz				○	○	○	○
1280 x 768 @ 60Hz				○	○	○	○
1280 x 800 @ 60Hz RB				○	○	○	○
1280 x 800 @ 60Hz				○	○	○	○
1280 x 960 @ 60Hz				○	○	○	○
1280 x 1024 @ 60Hz				○	○	○	○
1360 x 768 @ 60Hz				○	○	○	○
1366 x 768 @ 60Hz				○	○	○	○
1400 x 1050 @ 60Hz				○	○	○	○
1600 x 1200 @ 60Hz				○	○	○	○
1680 x 1050 @ 60Hz RB				○	○	○	○
1600 x 1050 @ 60Hz				○	○	○	○
1920 x 1080 @ 60Hz				○	○	○	○
NTSC-M	○	○					
NTSC-J	○	○					
PAL-BDGIH	○	○					
576i (50Hz)			○		○		
480i (60Hz)			○		○		
480p (60Hz)			○		○		
576p (50Hz)			○		○		
720p (50Hz)			○		○		
720p (60Hz)			○		○		

1080i (50Hz)			○		○		
1080i (60Hz)			○		○		
1080p (50Hz)			○		○		
1080p (60Hz)			○		○		

- Note**
- ○: supported
 - Blank: not supported

Supported PBP input signal combination

		Main/Left picture signal source						
		AV	S-Video	YPbPr	VGA	DVI	HDMI	Display Port
Sub/ Right picture signal source	AV	×	×	×	○	○	○	○
	S-Video	×	×	×	○	○	○	○
	YPbPr	×	×	×	×	○	○	○
	VGA	○	○	×	×	○	○	○
	DVI	○	○	○	○	×	×	○
	HDMI	○	○	○	○	×	×	○
	Display Port	○	○	○	○	○	○	×

Troubleshooting

Problem	Solution
No picture	<p>Check the following:</p> <ul style="list-style-type: none"> • Is the display turned on? Check the power indicator of the display. • Is the signal source device turned on? Turn on the device and try again. • Are there any loose cable connections? Make sure that all cables are connected firmly. • Have you chosen an unsupported output resolution on the computer? Refer to Supported input signal resolution on page 37 to select a supported resolution and try again. • Have you chosen an unsupported output resolution on the DVD or Blu-ray disc player? Refer to Supported input signal resolution on page 37 to select a supported resolution and try again.
No sound	<p>Check the following:</p> <ul style="list-style-type: none"> • Have you turned on the mute function on the display or the input source device? Turn off the mute function or increase the audio volume level and try again. • Are there any loose cable connections? Make sure that all cables are connected firmly.
The computer input image looks strange	<ul style="list-style-type: none"> • Have you chosen an unsupported output resolution on the computer? Refer to Supported input signal resolution on page 37 to select a supported resolution and try again. • Use the Auto Adjustment function (See Adjust Screen on page 29) to let the display automatically optimize the display of computer image. • If the result of the Auto Adjustment function is not satisfactory, use the Clock Frequency, Phase, H. Position and V. Position functions to manually adjust the image.
The control panel buttons do not work	Have you locked the control panel buttons? Unlock the buttons and try again.

The remote control does not work	<ul style="list-style-type: none">• Have you locked the remote control function? Unlock the function and try again.• Check for incorrect battery orientation.• Check for dead batteries.• Check your distance and angle from the display.• Check whether remote control is properly being pointed at the display's remote control sensor window.• Check for any obstacle between the remote control and the remote control sensor window.• Check that the remote control sensor window is not under strong fluorescent lighting, or in direct sunlight.• Check for any devices (computer or personal digital assistant, PDA) nearby that transmit infrared signals which may cause interference to signal transmission between the remote control and the display. Turn off the infrared function of these devices.
----------------------------------	--