

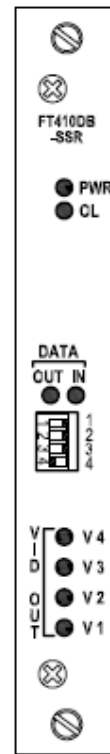

All Digital Fiber Optic Manufacturing Specialists

# Installation and Operation Manual

## FT410DB Series

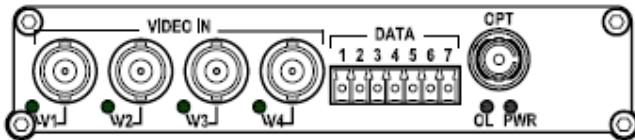

### 10-bit Digital Series

4-ch Video with 1 Bi-directional Data  
Fiber Optic Converter

## Models covered in this manual

### Standalone Units

#### Single-Mode Transmitters

FT410DB-SSTSA

FT410DB-SSTLSA

#### Single-Mode Receivers

FT410DB-SSRSA

FT410DB-SSRLSA

#### Multi-Mode Transmitter

FT410DB-SMTSA

#### Multi-Mode Receiver

FT410DB-SMRSA

### Card Modules

#### Single-Mode Transmitters

FT410DB-SST

FT410DB-SSTL

#### Single-Mode Receivers

FT410DB-SSR

FT410DB-SSRL

#### Multi-Mode Transmitter

FT410DB-SMT

#### Multi-Mode Receiver

FT410DB-SMR

### **Remark:**

If the optical connector is FC type, the suffix in the model number will be “-**FXX**”. Eg.

FT410DB-**FST**

## Table of Contents

|     |   |    |
|-----|---|----|
| (1) | SAFETY INSTRUCTIONS.....                          | 3  |
| (2) | PRODUCT OVERVIEW .....                            | 4  |
|     | 2.1 Introduction.....                             | 4  |
|     | 2.2 Models selection table .....                  | 5  |
| (3) | INSTALLATION .....                                | 6  |
|     | 3.1 General.....                                  | 6  |
|     | 3.2 Standalone unit installation.....             | 6  |
|     | 3.3 Card module installation .....                | 6  |
| (4) | CABLE CONNECTIONS & SETUP PROCEDURES.....         | 7  |
|     | 4.1 System cable connections .....                | 7  |
|     | 4.2 Data port assignment and pin connections..... | 9  |
|     | 4.3 Dip switch setting procedures .....           | 10 |
|     | 4.4 Ground connection .....                       | 12 |
| (5) | OPERATIONAL GUIDES .....                          | 13 |
|     | 5.1 FT410DB Series Transmitter .....              | 13 |
|     | 5.2 FT410DB Series Receiver .....                 | 13 |
| (6) | SPECIFICATIONS.....                               | 14 |
| (7) | DRAWINGS.....                                     | 15 |
| (8) | WARRANTY INFORMATION .....                        | 15 |
| (9) | CONTACT INFORMATION .....                         | 15 |

## (1) Safety Instructions

**Please be familiar with all information in this manual prior to installation and operation.**

**Note 1:** The products described contain a Class 1 laser or LED fiber optic emitter. The following safety precautions apply.

**Warning:** Do not disconnect the fiber optic connector while the unit is powered up. Exposure to Class I invisible optical radiation is possible when the internal fiber optic connector is disconnected while the unit is powered up.

**Caution:** Any access to the controls, adjustments, or performing operations, which are other than those specified may result in hazardous radiation exposure. Permanent eye damage or other bodily injuries may be resulted from such exposure even for only seconds.

**Note 2:** This assembly contains parts sensitive to damage by electrostatic discharge (ESD). ESD precautionary procedures should be applied in the course of touching, removing or inserting parts or assemblies.

## (2) Product Overview

### 2.1 Introduction

The FT410DB Series products comprise of either single-mode or multi-mode fiber optic transmitters and receivers for the optical transmission of FOUR forward (Tx → Rx) video and ONE bi-directional (Tx ↔ Rx) data signal on one fiber. The products work at wavelengths of 1310nm and 1550nm with either a 9/125um or 62.5/125um fiber for single-mode or multi-mode transmission respectively.

A non-compressed 10-bit digital video transmission scheme is implemented which supports video in NTSC, PAL and SECAM formats. Transparent data transmission is also accomplished in RS232, RS422 and RS485 formats regardless of the type of communication protocol implemented within the system. Time Division Multiplex (TDM) technology is employed for digital transmission of forward video and data; whereas optical Wavelength Division Multiplex (WDM) technology is employed for simultaneous reverse data transmission as well as bi-directional data transmission.

For single-mode transmission, we also offer specifically designed products for long-haul transmissions up to 60km. These models include the letter “L” in the suffix, e.g. FT410DB-SSTL for Tx, FT410DB-SSRL for Rx, etc.

The FT410DB Series units are available as standalone units, which can be mounted horizontally or vertically wall-mounted on any fixture. The standalone unit comes with an external power supply FT-PA/12V, which can be powered by local 110/220V power.

The FT410DB Series units are also available as plug-in card modules installed in a 19” rack-mount chassis. Each plug-in card occupies one slot in the rack-mount chassis. The rack mount chassis has to be ordered separately, and comes with its own power supply for powering the installed card modules.

**2.2 Models selection table**

| Type             | Mode        | Models <sup>1</sup> | Descriptions   | Installation requirements                               | Remarks  |
|------------------|-------------|---------------------|--|---|--|
| Standalone Units | Single-Mode | FT410DB-SSTSA       | Single-mode 4-Ch. Video Transmitter & 1 Data Transceiver Standalone Unit           | Horizontally or vertically wall-mounted Standalone unit | FT-PA/12V external power supply is included for the Standalone unit <sup>2</sup> |
|                  |             | FT410DB-SSTLSA      | Single-mode Long-haul 4-Ch. Video Transmitter & 1 Data Transceiver Standalone Unit |   |  |
|                  |             | FT410DB-SSRSA       | Single-mode 4-Ch. Video Receiver & 1 Data Transceiver Standalone Unit              |   |  |
|                  |             | FT410DB-SSRLSA      | Single-mode Long-haul 4-Ch. Video Receiver & 1 Data Transceiver Standalone Unit    |   |  |
|                  | Multi-Mode  | FT410DB-SMTSA       | Multi-mode 4-Ch. Video Transmitter & 1 Data Transceiver Standalone Unit            |   |  |
|                  |             | FT410DB-SMRSA       | Multi-mode 4-Ch. Video Receiver & 1 Data Transceiver Standalone Unit               |   |  |
| Card Modules     | Single-Mode | FT410DB-SST         | Single-mode 4-Ch. Video Transmitter & 1 Data Transceiver Card Module               | Housed in FT-C18 chassis <sup>3</sup>                   | FT-C18 chassis has to be ordered separately                                      |
|                  |             | FT410DB-SSTL        | Single-mode Long-haul 4-Ch. Video Transmitter & 1 Data Transceiver Card Module     |   |  |
|                  |             | FT410DB-SSR         | Single-mode 4-Ch. Video Receiver & 1 Data Transceiver Card Module                  |   |  |
|                  |             | FT410DB-SSRL        | Single-mode Long-haul 4-Ch. Video Receiver & 1 Data Transceiver Card Module        |   |  |
|                  | Multi-Mode  | FT410DB-SMT         | Multi-mode 4-Ch. Video Transmitter & 1 Data Transceiver Card Module                |   |  |
|                  |             | FT410DB-SMR         | Multi-mode 4-Ch. Video Receiver & 1 Data Transceiver Card Module                   |   |  |

<sup>1</sup> If the optical connector is FC type, the suffix in the model number will be “-FXX”. Eg. FT410DB-FST

<sup>2</sup> FT-PA/12V works under 100 -240VAC, 50/60Hz power supply

<sup>3</sup> Refer to FT-C18 product manual for specifications

### (3) Installation

#### 3.1 General

All OT Systems products are thoroughly inspected, tested and securely packaged before delivery to ensure a stable, intact and trouble-free service. Please check the equipment upon receipt for any visible damage which may have been caused during shipping.

The FT410DB Series standalone units (Fig. 3.1) can be either horizontally or vertically wall-mounted, or mounted on any fixture. The Standalone unit works with an external power supply FT-PA/12V powered by local 110/220V power.

The FT410DB Series card modules are housed inside the FT-C18 rack-mount chassis (Fig. 3.2) with an included power supply unit. The whole chassis is powered by local 110/220V power. FT-C18 is a standard 19" (483mm) rack-mount chassis which occupies 4 rack units (177.8mm) in height. Each FT410DB card module occupies one slot and a total of 18 cards can be housed inside the chassis.



Fig. 3.1 Standalone unit



Fig. 3.2 FT-C18 chassis

#### 3.2 Standalone unit installation

- a) Mount the standalone unit onto a fixture, (either on the wall or on a flat surface) with four screws through the holes on the mounting frame to secure it in position.
- b) The provided power supply should also be mounted on the same fixture or in the proximity for connection of the supply cables to the unit, provided that an AC power supply socket is nearby for powering the adaptor.
- c) Connect all the signal inputs and outputs at the back of the unit with appropriate cables: fiber optic cable for optical link, BNC cables for video inputs/outputs (Tx/Rx), and UTP cable for data input/output (Tx/Rx).
- d) Once the unit is powered up, check that the red POWER LED on the unit is lit. If not, check the power supply cable connections between the unit and the power supply socket.
- e) With all the signals available at the input and output ports, check the status of LEDs located on the unit. With correct status of each LED, installation is now completed [for LEDs status, see **Operational Guides** on this manual's section (5)].

### 3.3 Card module installation

- a) Insert the card module into the FT-C18 chassis along the top and bottom card guides of an empty slot and push the card into the multi-pin socket at the rear firmly. Secure with the provided thumb screws.
- b) Repeat the above procedure for all the rest card modules. Unused slots must be covered with blank panels provided.
- c) Connect all the signal inputs and outputs at the back of the unit with appropriate cables: fiber optic cable for optical link, BNC cables for video inputs/outputs (Tx/Rx), and UTP cable for data input/output (Tx/Rx).
- d) Once the chassis is powered up, check that the red POWER LED on the front and back panels of the card modules are lit. If not, check the power supply cable connections between the chassis and the power supply socket. For failures of individual card's POWER LEDs, check the corresponding card modules, whether they have been inserted properly.
- e) With all the signals available at the input and output ports, check the status of LEDs located on the unit. With correct status of each LED, installation is now completed [for LEDs status, see **Operational Guides** on this manual's section (5)].

## (4) Cable Connections & Setup Procedures

### 4.1 System cable connections

| Signal Type | Cable Type                      | Connector            |
|-------------|---------------------------------|----------------------|
| Optical     | Single-mode or Multi-mode fiber | ST (or FC) Connector |
| Video       | Coaxial Video Cable             | BNC Connector        |
| Data        | Twisted-pair Cable              | Screw Terminal Block |

#### Typical System Cable Connections Diagrams:

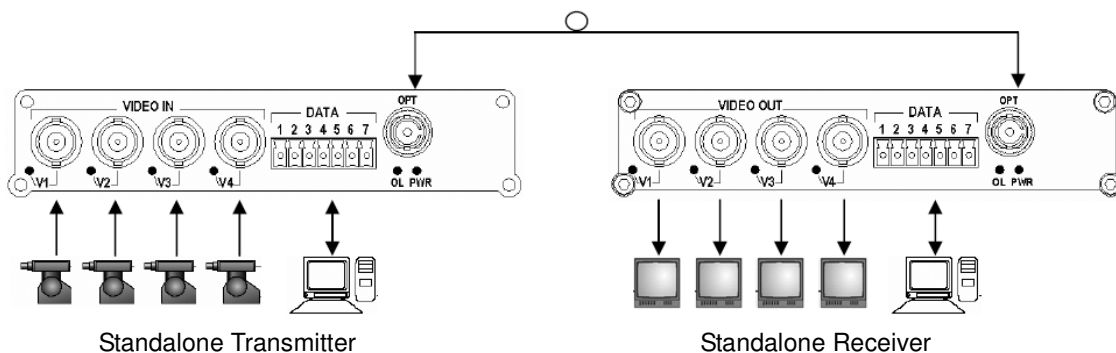
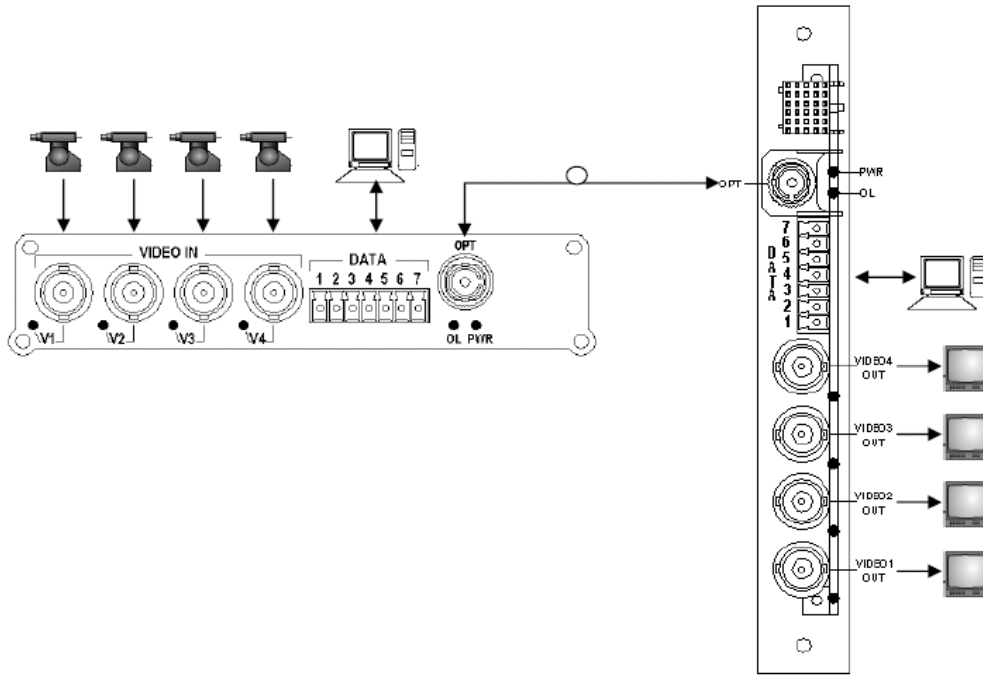

Fig 4.1 Standalone unit to Standalone unit connection diagram





Standalone Transmitter

Card Module Receiver

Fig 4.2 Standalone unit to Card Module connection diagram

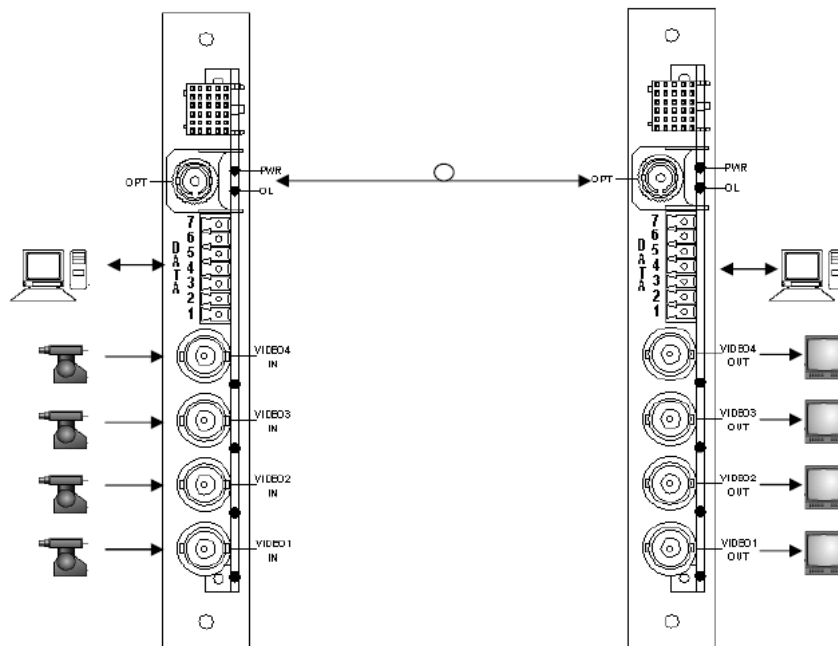

Card Module Transmitter

Card Module Receiver

Fig 4.3 Card Module to Card Module connection diagram

## 4.2 Data port assignment and pin connections

For data input and output connections, please note the following pin assignment:

| <b>Pin Assignment</b><br>(Screw Terminal Block) | <b>1</b>          | <b>2</b>          | <b>3</b>      | <b>4</b>      | <b>5</b>  | <b>6</b>   | <b>7</b>        |
|---|-------------------|-------------------|---------------|---------------|-----------|------------|-----------------|
| <b>Data format</b>                              |                   |                   |               |               |           |            |                 |
| <b>RS422/485 (4-Wire)</b>                       | <b>IN(+)</b>      | <b>IN(-)</b>      | <b>OUT(+)</b> | <b>OUT(-)</b> | N/A       | N/A        | N/A             |
| <b>RS485 (2-Wire)</b>                           | <b>IN/OUT (+)</b> | <b>IN/OUT (-)</b> | N/A           | N/A           | N/A       | N/A        | N/A             |
| <b>RS232</b>                                    | N/A               | N/A               | N/A           | N/A           | <b>IN</b> | <b>OUT</b> | <b>Sig. COM</b> |

### 4-Wire RS422/485 Full Duplex Data communication connection diagram:

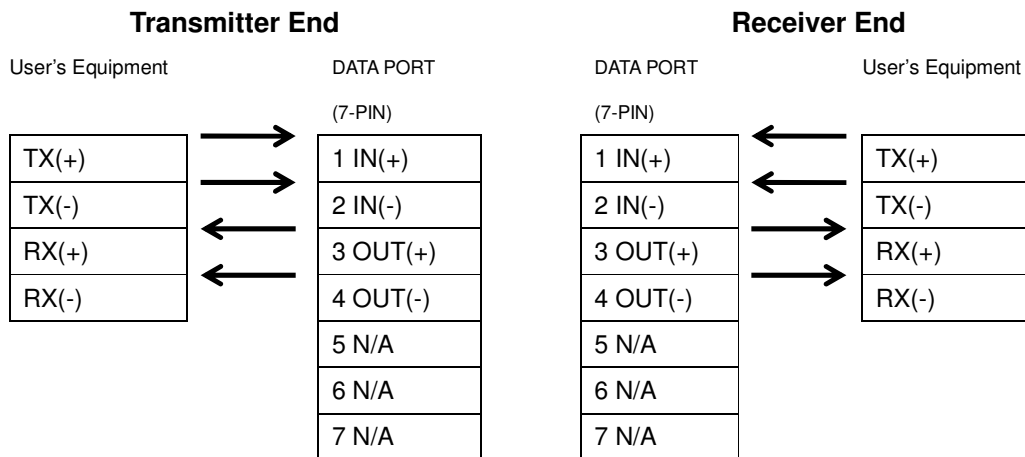

Fig. 4.4.1 Connector Pin Assignments for 4-wire RS422/485 data format at Data port

### 2-Wire RS485 Half Duplex Data communication connection diagram:

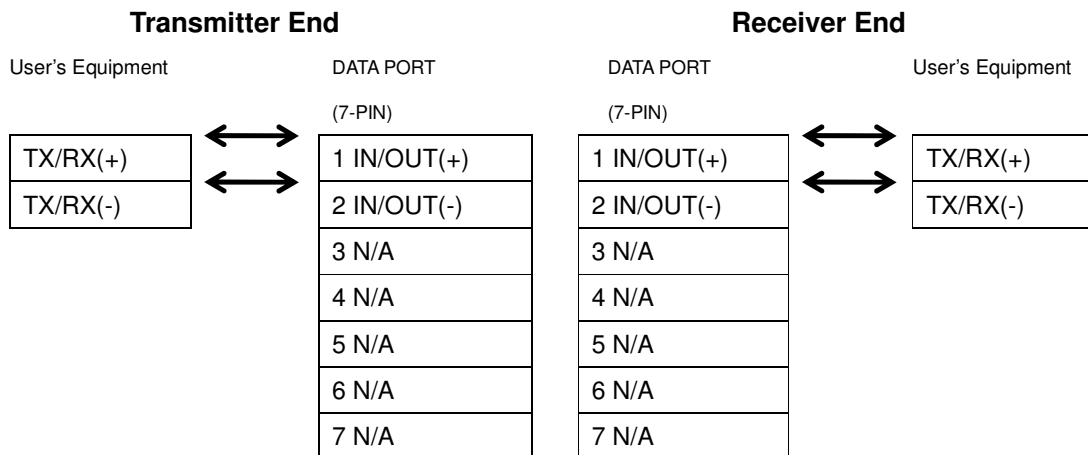

Fig. 4.4.2 Connector Pin Assignments for 2-wire RS485 data format at Data port.

**RS232 Data communication connection diagram:**

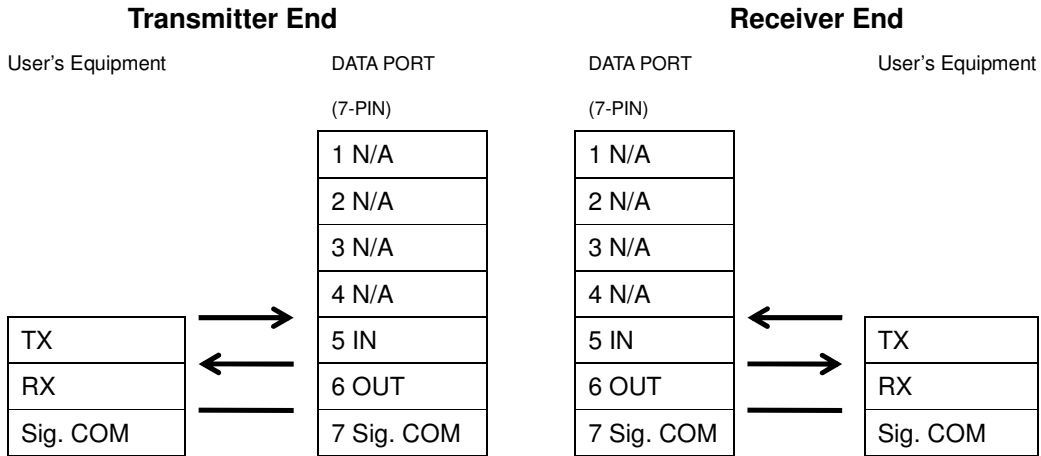
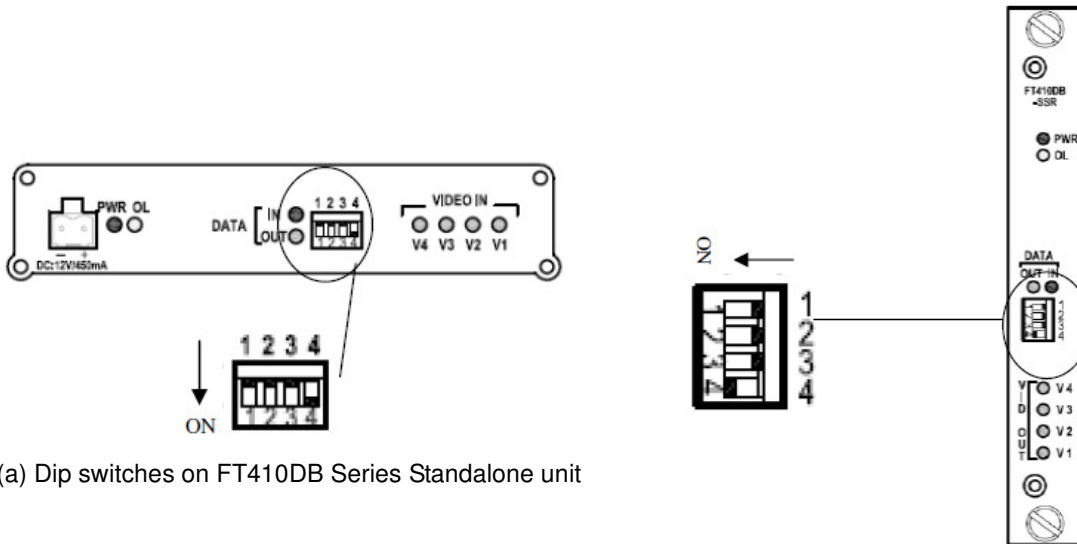

Fig. 4.4.3 Connector Pin Assignments for RS232 data format at Data port

**4.3 Dip switch setting procedures**

The only setup procedure is to select the appropriate line terminations and data transmission formats. Selections must be made by setting the dip switches (Fig. 4.5) through the access on the front panel.



(b) Dip switches on FT410DB Series Card Module

Fig. 4.5 Location of Dip Switches

**Dip switch settings for various types of data transmissions**

| Function / Switch No.      | Sw. 3      | Sw. 4     |
|----------------------------|------------|-----------|
| RS485 (2-Wire)             | OFF        | OFF       |
| <b>RS422/485 (4-Wire)*</b> | <b>OFF</b> | <b>ON</b> |
| RS232                      | ON         | OFF       |

*\* Factory setting [RS422/485 (4-Wire)]*

**Dip switch settings for line terminations**

Line Output Termination

| Function / Switch No.            | Sw. 1      |
|----------------------------------|------------|
| Line Output Terminated           | ON         |
| <b>Line Output Unterminated*</b> | <b>OFF</b> |

Line Input Termination

| Function / Switch No.           | Sw. 2      |
|---------------------------------|------------|
| Line Input Terminated           | ON         |
| <b>Line Input Unterminated*</b> | <b>OFF</b> |

*\* Factory setting (Line Output and Line Input "Unterminated")*

**Industrial practice for line terminations**

For RS422 4-wire communication, it is suggested to keep the input and output lines terminated in the ONE Tx to ONE Rx configuration.

For RS485 2/4-wire communication, the RS485 device can be disabled to stay in a Hi-Z state. It is very important that the data lines have to be terminated with a resistor being connected across the pair wires so as to eliminate the residual standing signal waves on the lines in the Hi-Z line condition. So, it is recommended that the lines should be terminated with the appropriate resistance. When more than one RS485 device are connected in a daisy-chain configuration, only the farthest device on the loop, i.e. the device located at the end of the line, should be terminated; whereas the middle ones are set to "Unterminated" status. See the figure 4.6 below for reference.

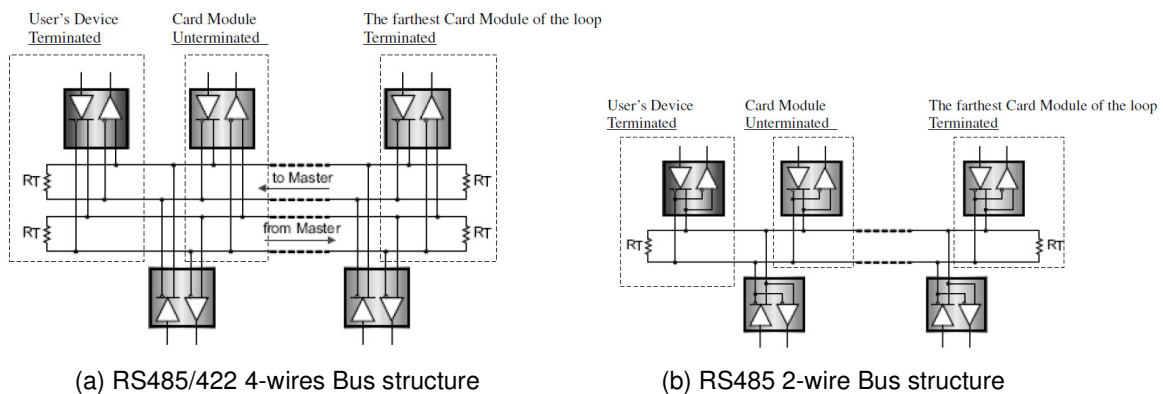

Fig. 4.6 Termination of different Bus structures

#### 4.4 Ground connection

For enhanced safety to reduce the risks of electrical shock and physical damage, caused by lightning and other power surges, as well as a connection to the surge suppression devices in the product, a screw terminal is provided on the Standalone cabinets (Fig. 4.7). It is highly recommended that the Standalone unit have good ground connections to the buildings ground in accordance with the local codes.

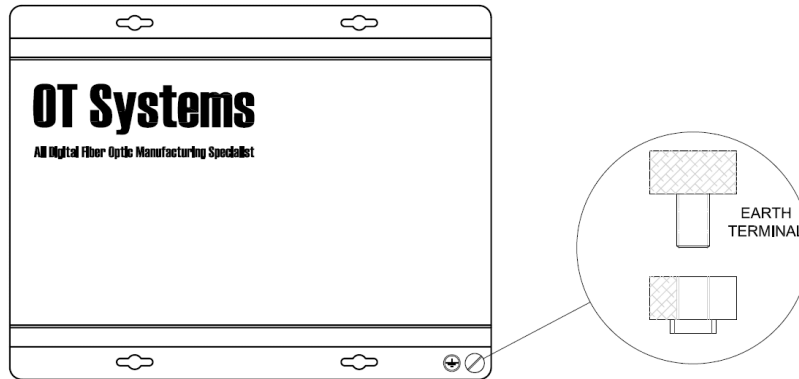

Fig. 4.7 Standalone unit earth terminal location

## (5) Operational Guides

### 5.1 FT410DB Series Transmitter

#### LED Indicators

| Indicator  | Color  | Description   |
|--|--------|---|
| PWR  | Red    | Lit when power is supplied to the Transmitter.                  |
| OL   | Yellow | Lit when optical signal from receiver to transmitter is active. |
| VIDEO IN /<br>VIN  | V1     | Green   |
|  | V2     | Green   |
|  | V3     | Green   |
|  | V4     | Green   |
| Lit when video signals are fed into the VIDEO IN connectors. |        |   |
| DATA   | IN     | Red   |
|  | OUT    | Green   |
| Blinks when input data is available at Tx.                   |        |   |
| Blinks when output data is available at Tx.                  |        |   |

#### Signal Ports

|            |  |
|------------|--|
| OPT -      | ST (or FC) Optical Connector for fiber cable connection. |
| VIDEO IN - | BNC Video Connectors for video signal inputs.            |
| DATA -     | 7-pin Screw Terminal Block for data signal.              |

### 5.2 FT410DB Series Receiver

#### LED Indicators

| Indicator  | Color  | Description   |
|--|--------|---|
| PWR  | Red    | Lit when power is supplied to the Receiver.                     |
| OL   | Yellow | Lit when optical signal from transmitter to receiver is active. |
| VIDEO<br>OUT /<br>VOUT                                       | V1     | Green   |
|  | V2     | Green   |
|  | V3     | Green   |
|  | V4     | Green   |
| Lit when video signals are received at VIDEO OUT connectors. |        |   |
| DATA   | IN     | Red   |
|  | OUT    | Green   |
| Blinks when input data is available at Rx.                   |        |   |
| Blinks when output data is available at Rx.                  |        |   |

#### Signal Ports

|             |  |
|-------------|--|
| OPT -       | ST (or FC) Optical Connector for fiber cable connection. |
| VIDEO OUT - | BNC Video Connectors for video signal outputs.           |
| DATA -      | 7-pin Screw Terminal Block for data signal.              |

## (6) Specifications

| PARAMETERS                  | MODELS*        | FT410DB-SST(R)SA<br>FT410DB-SST(R)<br>(Single-Mode)                                  | FT410DB-SST(R)LSA<br>FT410DB-SST(R)L<br>(Single-Mode) | FT410DB-SMT(R)SA<br>FT410DB-SMT(R)<br>(Multi-Mode) |
|-----------------------------|----------------|--|---|--|
|                             | <b>OPTICAL</b> |  |   |  |
| No. of Fiber / Connector    |                | 1 / ST (or FC)   | 1 / ST (or FC)  | 1 / ST (or FC)                                     |
| Wavelength                  |                | 1310/1550 nm   | 1550/1310 nm  | 1310/1550 nm                                       |
| Optical Power Budget        |                | 17 dB  | 24 dB   | 23 dB  |
| Max Distance                |                | 40 km  | 60 km   | 2 km   |
| <b>ELECTRICAL VIDEO</b>     |                |  |   |  |
| Channel / Connector         |                | 4 / BNC  |   |  |
| System                      |                | PAL, NTSC, SECAM   |   |  |
| Bandwidth                   |                | ≥ 6.0 MHz  |   |  |
| Input/Output Impedance      |                | 75 Ohm   |   |  |
| Input/Output Level          |                | 1.0 Vp-p typical   |   |  |
| Differential Gain           |                | < 1% typical   |   |  |
| Differential Phase          |                | < 1° typical   |   |  |
| SNR                         |                | >65dB  |   |  |
| <b>DATA</b>                 |                |  |   |  |
| Channel / Connector         |                | 1 / 7-pin Screw Terminal   |   |  |
| Direction                   |                | Bi-directional (Duplex)  |   |  |
| Electrical Format           |                | RS232, RS422, RS485 (2-wire, 4-wire) Tri-state                                       |   |  |
| Transmission Rate           |                | 0~256Kbps  |   |  |
| <b>POWER</b>                |                |  |   |  |
| Power consumption           |                | 12VDC @ 5.4W   |   |  |
| Power Supply                |                | Standalone Unit: FT/PA12V DC Adaptor<br>Card module: Powered by FT-C18 chassis       |   |  |
| Connector (Standalone unit) |                | 2-pin Screw Terminal   |   |  |
| <b>PHYSICAL</b>             |                |  |   |  |
| Weight                      |                | Standalone unit: 0.58 kg      Card module: 0.25 kg                                   |   |  |
| Dimensions (W x H x D)      |                | Standalone unit: 156 x 30.5 x 223 mm (MAX)<br>Card module: 148 x 20.4 x 213 mm (MAX) |   |  |
| <b>ENVIRONMENTAL</b>        |                |  |   |  |
| Operating Temperature       |                | -40°C ~ +75°C  |   |  |
| Storage Temperature         |                | -40°C ~ +85°C  |   |  |
| Relative Humidity           |                | 0 ~ 95% non-condensing   |   |  |
| <b>MTBF</b>                 |                | >100'000 Hours   |   |  |

\*If the optical connector is FC type, the suffix in the model number will be "-FXX". Eg. FT410DB-FST

## (7) Drawings

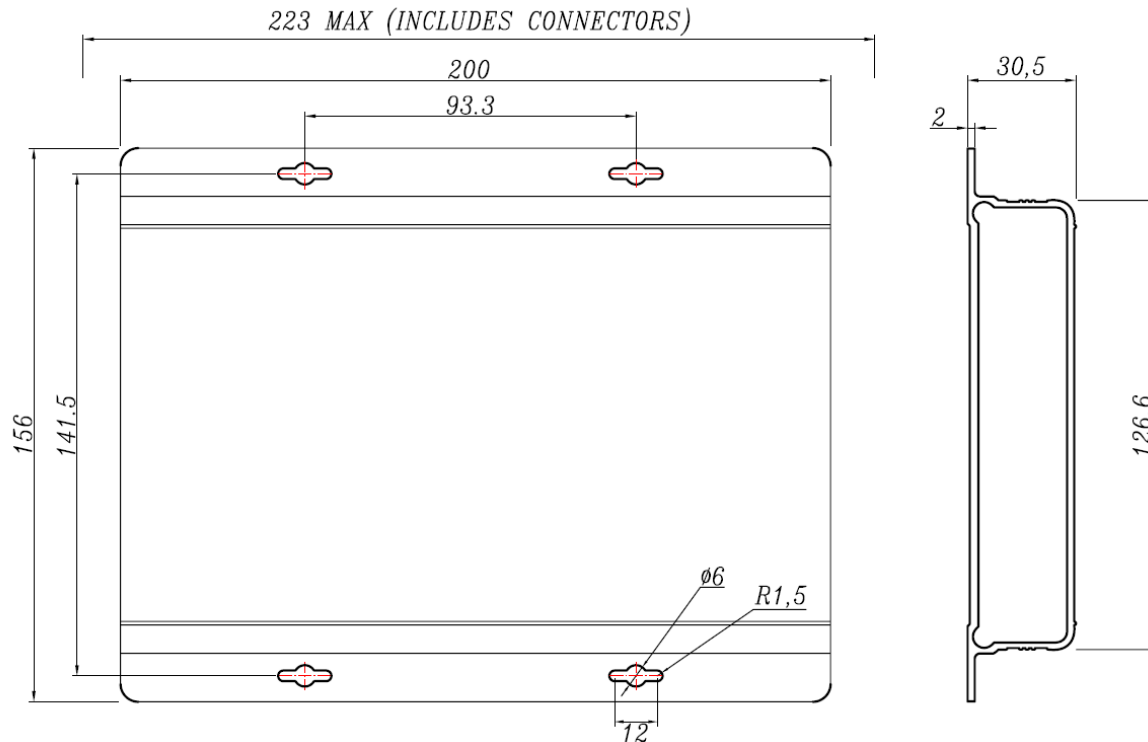

Fig. 7.1 Dimensional drawings of Standalone unit (mm)

## (8) Warranty Information

All OT Systems products are subject to a limited life-time warranty offered by the company in normal circumstances. Please refer to the OT Systems Products Warranty Statement for details. Access to the statement is available in our company website at [www.ot-systems.com](http://www.ot-systems.com).

## (9) Contact Information

### OT Systems Ltd. (Hong Kong)

Unit 1023, 10/F Landmark North  
 39 Lung Sum Avenue  
 Sheung Shui, N.T., Hong Kong  
 Tel. +852 2672 5153  
 Fax. +852 2679 0756  
[sales@ot-systems.com](mailto:sales@ot-systems.com)

### OT Systems Ltd. (USA)

River Heights Business Park  
 5375 US Highway 34  
 Oswego, IL 60543, USA  
 Tel. +1 630 554 9178  
 Fax. +1 630 554 9179  
[sales.usa@ot-systems.com](mailto:sales.usa@ot-systems.com)