



EN

# User Manual

**1/2.8" Network Dome, Fix,  
Day&Night, 1920x1080,  
Infrared, 12VDC, PoE, IP66**

**IED-62F0036M0A**

**IED-62V2812M0B**

## Table of content

<b>Parts supplied</b> .....	<b>5</b>
<b>Part names</b> .....	<b>6</b>
<b>Installation instructions</b> .....	<b>7</b>
Pan & Tilt adjustments .....	8
Power supply connections .....	9
<b>General Description</b> .....	<b>10</b>
<b>Specification</b> .....	<b>11</b>
<b>Quick Network Setup</b> .....	<b>13</b>
<b>Further information</b> .....	<b>13</b>
<b>Full Menu Setup</b> .....	<b>14</b>
Web viewer description .....	14
Setup Menu Table .....	15
<b>LIVE VIEW</b> .....	<b>16</b>
Player control & Display .....	16
Video stream & Protocol .....	16
<b>SETUP</b> .....	<b>17</b>
Information .....	17
Video & Image .....	17
Event .....	29
System .....	42
<b>USER MANUAL</b> .....	<b>52</b>
<b>Troubleshooting</b> .....	<b>53</b>

## Safety instructions

### General safety instructions

- Before switching on and operating the system, first read this safety advice and the operating instructions.
- Keep the operating instructions in a safe place for later use.
- Installation, commissioning and maintenance of the system may only be carried out by authorised individuals and in accordance with the installation instructions - ensuring that all applicable standards and guidelines are followed.
- Protect the devices from water penetration and humidity, since these can cause lasting damage.
- Should moisture nevertheless enter the system, under no circumstance switch on the devices under these conditions, instead send them for examination to an authorised specialist workshop.
- The system must never be used outside of the technical specifications, since this can destroy it.
- The device must be protected from excesses of heat, dust, humidity and vibration.
- When separating the system from the voltage supply, only ever use the plug to pull out the cable. Never pull directly on the cable itself.
- Lay the connecting cables carefully and check that they are not mechanically stressed, kinked or damaged and that no humidity can penetrate into them.
- In the event of a malfunction, please inform your supplier.
- Maintenance and repairs may only be carried out by authorised specialist personnel.
- The system must be isolated from the power supply before opening the housing.
- The device may only be opened by qualified service personnel. Unauthorised access invalidates any warranty claim.
- Connection cables should always be exchanged through Videor E. Hartig GmbH.
- Use only original spare parts and accessories from Videor E. Hartig GmbH.
- The housing should only be cleaned using a mild domestic cleaning agent. Never use solvents or petrol as these can permanently damage the surface.
- During installation, it is essential to ensure that the seals provided are correctly installed and that they are not displaced during installation. Damaged seals must not be installed and will invalidate any warranty.
- The installer is responsible for the maintenance of the enclosure as per the technical data, e.g. by sealing the cable outlets with silicone.
- Wire end ferrules should be used when shortening the flexible connection cables.
- The devices may only be operated in the temperature range indicated in the data sheet and within the defined air humidity range.

### Product - Specific Safety Instructions

- The camera may never be pointed directly at the Sun with the aperture open (this will destroy the sensor).
- It is unavoidable that during manufacture and to a certain extent during later use, humidity will be present in the ambient air within the device's housing. In the event of large temperature fluctuations, this humidity may condense inside the housing.
- To avoid this condensation inside the very tightly sealed housing, the manufacturer has inserted silica gel sachets in the housing of the various camera types.
- It is however a physical given, that these silica gel bags will reach saturation after a certain amount of time. They should therefore be replaced with new silica gel sachets.
- During installation, it is essential to ensure that the seals provided are correctly installed and that they are not displaced during installation. Damaged seals must not be installed and will invalidate any warranty.
- A multipolar, easily accessible isolation device should be installed in the proximity of the IR Spotlight, in order to disconnect the device from the power supply for service work.
- The earth connection must be made according to the low impedance requirement of DIN VDE 0100.
- Subsequent painting of the equipment surface can impair the function.
- Any warranty claim is invalidated by subsequent painting.
- A safety margin of > 1m from the spotlight must be maintained when viewing directly into the IR Spotlight in a darkened environment.
- Do not look directly at invisible LED radiation using optical instruments (e.g. a reading glass, magnifying glass or microscope), since this can endanger the eyes, LED Class 1M.
- Operation of the IR spotlight with a defective cover or during repair is prohibited.

### Class A device note

This is a Class A device. This device can cause malfunctions in the living area; in such an event, the operator may need to take appropriate measures to compensate for these.

### WEEE (Waste Electrical & Electronic Equipment)

Correct Disposal of This Product (Applicable in the European Union and other European countries with separate collection systems).



This marking shown on the product or its literature, indicates that it should not be disposed with other household wastes at the end of its working life. To prevent possible harm to the environment or human health from uncontrolled waste disposal, please separate this from other types of wastes and recycle it responsibly to promote the sustainable reuse of material resources. Household users should contact either the retailer where they purchased this product, or their local government office, for details of where and how they can take this item for environmentally safe recycling. Business users should contact their supplier and check the terms and conditions of the purchase contract. This product should not be mixed with other commercial wastes for disposal.

## Graphical symbols

Please pay attention to the safety instructions, and carefully read through this instruction guide before initial operation.



Important points of warning are marked with a caution symbol.



Important points of advice are marked with a notice symbol.

## Parts supplied

- Dome Camera
- Operating Instruction
- CD
- Mounting Template
- Plastic Anchor: 6.5 x 26.6mm (4x)
- Mounting Screw: 4 x 25mm (4x)
- L-Wrench (1x)

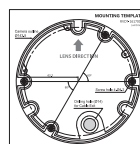
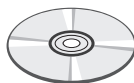
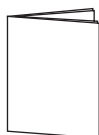
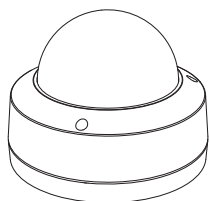

## Part names

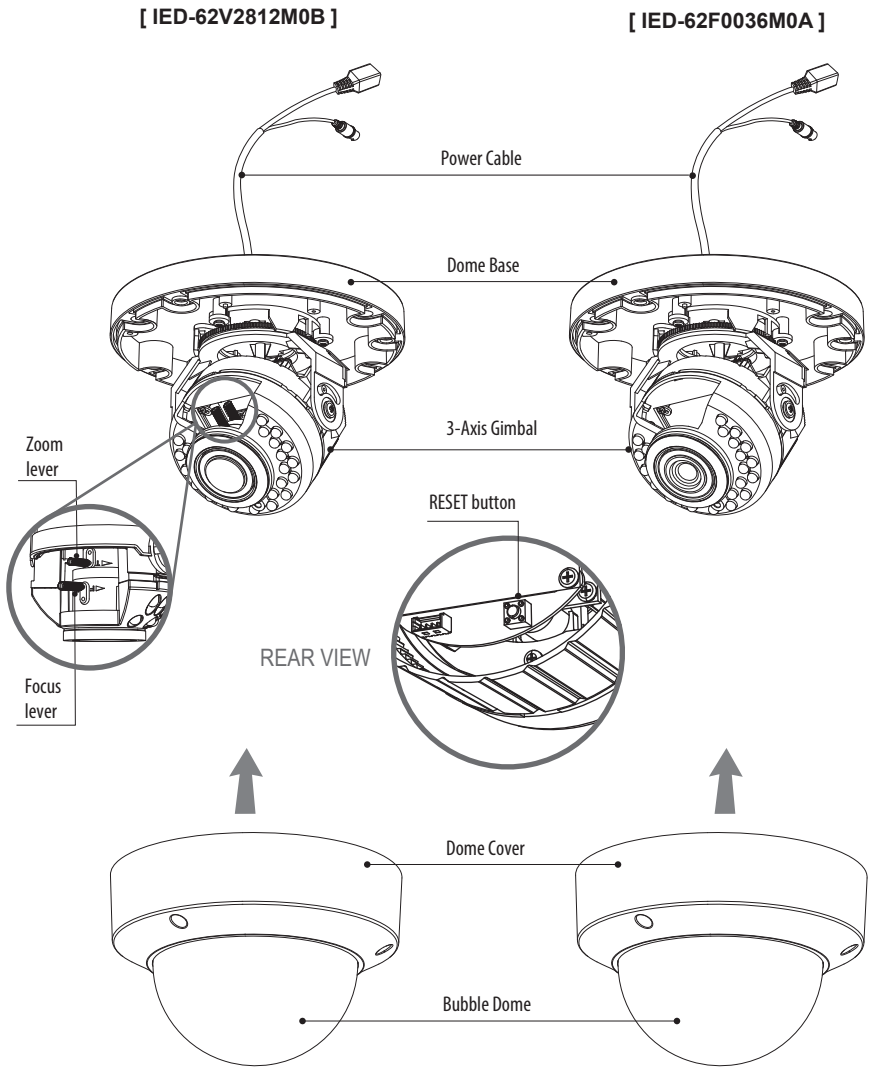

## Installation instructions



**CAUTION:** The camera's base should be attached to a structural object, such as concrete, hard wood, wall stud or ceiling rafter that supports the weight of the camera. If necessary use appropriate mounting material (e.g. anchors) instead of the material enclosed with the camera.

1. Drill three holes for mounting on the ceiling or wall.
2. Route the power & ethernet cable to the connecting place.
3. Place the dome base at the pre-drilled installation position and fix it by using mounting screws.
4. Adjust the camera's viewing angle (Pan, Tilt, Rotation)
5. Assemble the dome cover to the dome base unit.

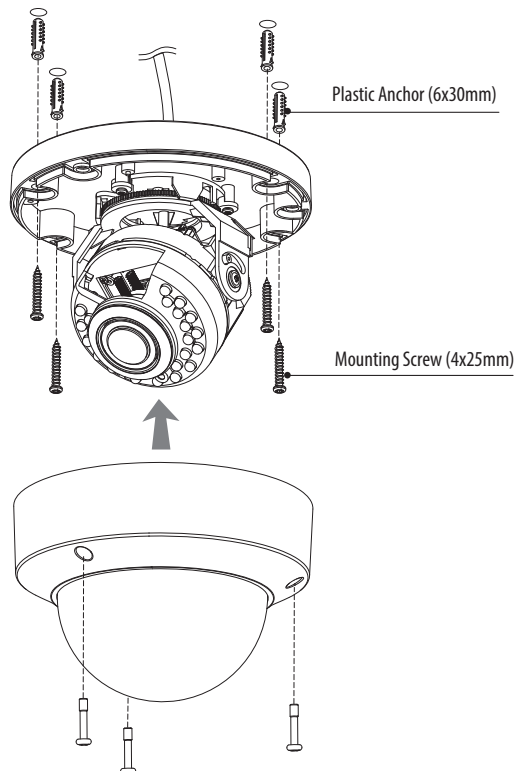

## Pan & Tilt adjustments

1. Pan limit: Adjusts the first pan angle by turning the gimbal 360°.
2. Tilt limit: Tilt is limited to 25°min ~ 90°max. with reference to the ceiling when the inclination of camera module is 0°, that is, the image is aligned horizontally.
3. Rotation limit (Horizontal image alignment): Adjust the rotation angle by turning the upper gimbal 360°.

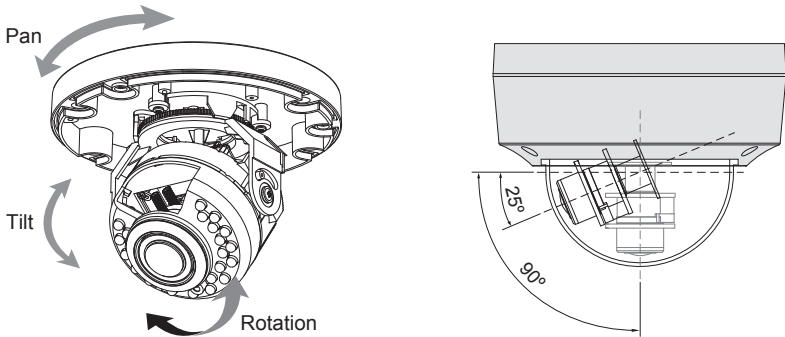

### Zoom & focus adjustments (IED-62V2812M0B)

- Turn the Focus lever to "N"(Near) or " $\infty$ "(Far) until the sharpest focus is made.
- To widen the viewing angle, turn the Zoom to "W"(Wide) and to obtain a closer view, turn it to "T"(Tele)



#### CAUTION :

- Be careful with the cable twisting during pan or tilt adjustments.
- Extreme care should be taken NOT to scratch the bubble dome surface while the camera installing or adjusting.
- Care should be taken the cable is NOT to be damaged, kinked or exposed in the hazardous area.
- Do not expose the camera directly to a strong light source such as the sun or spot light.



## Power supply connections

Make sure the power is removed before the installation. Camera can work with either 12VDC or PoE (IEEE Std. 802.3af). Primary and secondary grounds are completely isolated to avoid the possible ground loop problems.

1. Plug the network cable into RJ-45 Ethernet Port. If PoE is the unique power, there will be no need to connect Power terminal.
2. When DC12V Local power is necessary, connect the low voltage (DC12V) first, then plug the DC adapter to DC outlets to avoid an improper reset from power jitter and a damage from the surge voltage when no load.

**i** When PoE and local power are connected at the same time, local power has priority.

## General Description

- Full-HD 2Mega Pixel, NETWORK CAMERA, 1920x1080(30p/25p)
- ONVIF Conformance
- Zero configuration
- Cross Web Browsing (IE, Edge, Safari, Firefox, Chrome)
- Adaptive web resizing depending on layout & resolution of display device by RESPONSIVE WEB
- Increased usability for all PC, tablet and mobile
- Simultaneously H.264 & MJPEG (Triple streaming)
- ONVIF Event Mapping
- Lens
  - > IED-62V2812M0B : f=2.8~12mm F1.4, Mega pixel Vari-focal lens
  - > IED-62F0036M0A : f=3.6mm F2.3, Mega pixel Fixed lens
- Dual Filter Switcher
- D-WDR (Digital Wide Dynamic Range)
- Improved noise figure with the enhanced 3DNR
- Simple-LDC(Lens Distortion Compensation)
- VCA(Video Contents Analysis) function
- Motion Detection, Privacy Mask, Tamper, Defog, BLC/HLC, D-Zoom(~16x), Mirror/Flip, LDC(Lens Distortion Correction), Sens-up(Slow Shutter), Smart IR, Hue, Contrast, Brightness, Saturation, Sharpness, Auto-Flickerless, VerticalView(90°/270°)
- Circuit protection against faulty connection in power polarity
- PoE(IEEE Std. 802.3af) & DC12V
- Built-in 30pcs IR-LED
- 3-Axis Gimbal, Surface mount
- One side Anti-scratch hard coated clear bubble dome
- Optimized Cooling System
- IP66/IK10 Protection

## Specifications

ITEM	IED-62V2812M0B	IED-62F0036M0A
<b>Imaging Sensor</b>	1/2.8" Sony 2.3Mega pixel RGB Bayer Array CMOS Sensor	
<b>Effective Pixels</b>	1920(H) x 1080(V) approx. 2.07Mega pixels (Full-HD mode)	
<b>Sensitivity</b>	Color Mode: 0.15 lux (LED off), B/W Mode: 0.03 lux (LED off)	
<b>Scanning mode</b>	Progressive Scan	
<b>S/N Ratio</b>	54dB	
<b>Day &amp; Night mode</b>	ICR by Auto, Day, Night, External, Color DN	
<b>WDR</b>	Digital WDR (ATR-EX)	
<b>DNR</b>	2D-NR, 3D-NR	
<b>Auto Exposure</b>	Automatic (Priority: Frame rate/Low noise), Manual	
<b>Shutter Speed Control</b>	Automatic: Min. 1/10,000 sec ~ Max. 30/25 sec Manual: Min. 1/10,000 sec ~ Max. 30/25 sec	
<b>Gain Control</b>	Automatic: ~ Max. 46.2dB, Manual: ~ Max. 46.2dB	
<b>Auto White Balance mode</b>	ATW-Indoor/Outdoor, Automatic, Shade, Clear sky, Fluorescent light, Light bulb, Flame, Manual	
<b>Lens</b>	f= 2.8~12mm F1.4, Mega pixel Auto Iris Vari-focal lens	f= 3.6mm F2.3, Mega pixel Fixed lens
<b>LEDs</b>	Built-in 30pcs x 850nm IR-LED	
<b>Functions</b>	Privacy Mask, Motion Detection, Tamper, Defog, D-Zoom(~x16), HLC/ BLC, LDC (Lens Distortion Compensation), Mirror/Flip, Sens-up(Slow shutter), Hue, Brightness, Contrast, Saturation, Sharpness, Auto-Flickerless, Smart IR, VCA(Video Contents Analysis), VerticalView (90°/270°)	
<b>Installation Temp.</b>	-20°C ~ +50°C (Humidity : 20%RH ~ 80%RH)	
<b>Operating Temp.</b>	-20°C ~ +50°C (Humidity : 20%RH ~ 80%RH)	
<b>Dimension</b>	144mm(Ø)x108mm(H)_ Ø100-bubble	
<b>Housing</b>	IP66/IK10, Aluminum Cast, Surface mount, Optimized Cooling system, 3-Axis gimbal, One side Anti-scratch hard coated clear bubble dome	
<b>Power Source</b>	PoE(IEEE Std. 802.3af ), DC12V=600mA, 7.5W Circuit protection against faulty connection in power polarity.	
NETWORK SPECIFICATION		
<b>Video Compression</b>	H.264(High, Main, Base line profile) MJPEG	
<b>Video Resolution</b>	1920x1080, 1600x900, 1280x720, 960x540, 640x360, 320x180	
<b>Video Frame Rate</b>	Up to 30/25fps@1920x1080p	
<b>Video Streaming</b>	Simultaneously H.264 and MJPEG (Triple Streaming) Independent Frame Rate and Bandwidth Control, CVBR/CBR Mode	
<b>FTP Uploading</b>	MJPEG Still Image	
<b>Login Authority</b>	Administrator, Operator, Guest	

## Specifications

<b>Security</b>	Multi User Authority, IP Filtering, HTTPS, Video Stream, Export/Import
<b>Network Time Sync.</b>	Synchronize Computer/NTP Server, Manual
<b>Software Reset</b>	Restart, Reset, Factory Default
<b>Auto Recovery</b>	Backup, Restore
<b>Remote Upgrade</b>	Using Web Browser
<b>Protocol</b>	TCP/IP, UDP, IPv4/v6, HTTP, HTTPS, FTP, UPnP, RTP, RTSP, RTCP, DHCP, ARP, Zeroconf, Bonjour
<b>Client Software</b>	Built-In Web, ONVIF Compatible 3rd Party VMS
<b>SDK Support</b>	API, ONVIF Profile S Compliant
<b>Audio &amp; Alarm</b>	Not Available

(\*) Design and specifications are subject to change for product improvements without prior notice.

## Quick Network Setup

1. After the camera is connected to the network, start '**eneo Scan Device**' tool (enclosed CD).
2. Use the '**Scan eneo**' button to find the camera in your network.
3. By default the camera is set to DHCP. If there is no DHCP server present in the network the camera will fall back to a default IP address after a while. In this scenario please only add one camera at a time to the network to avoid conflicts due to identical IP addresses.  
The network camera's default IP address is: **192.168.1.10**.
4. Right clicking the device name in the eneo Scan Device tool will bring up the context menu. Use the '**Open Device Web Site**' option to access the camera.
5. The web viewer login page will open up in your default web browser.  
In case of Microsoft Internet Explorer install Active-X named VIDEOR E. Hartig GmbH according to the instruction at the bottom of the browser.
6. Use the default user name and password to log in.

Default user name: admin

Default password: admin

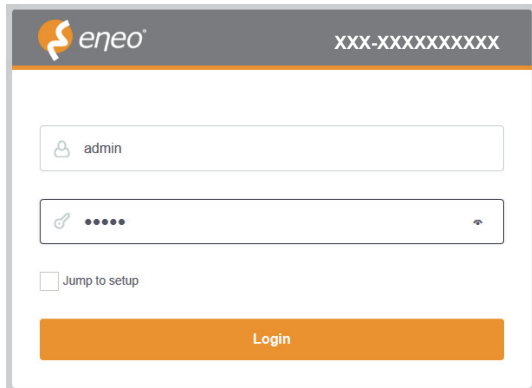

## Further information

Make sure to always upgrade to the latest firmware version available from the eneo web site at [www.eneo-security.com](http://www.eneo-security.com) to receive the latest functionality for your product.

The manual, and other software tools are available on the eneo website at [www.eneo-security.com](http://www.eneo-security.com) or on the included CD.

Information on compatible video management software solutions can be found in the category **Videomanagement** at [www.eneo-security.com](http://www.eneo-security.com).

## Full Menu Setup

### Web viewer description

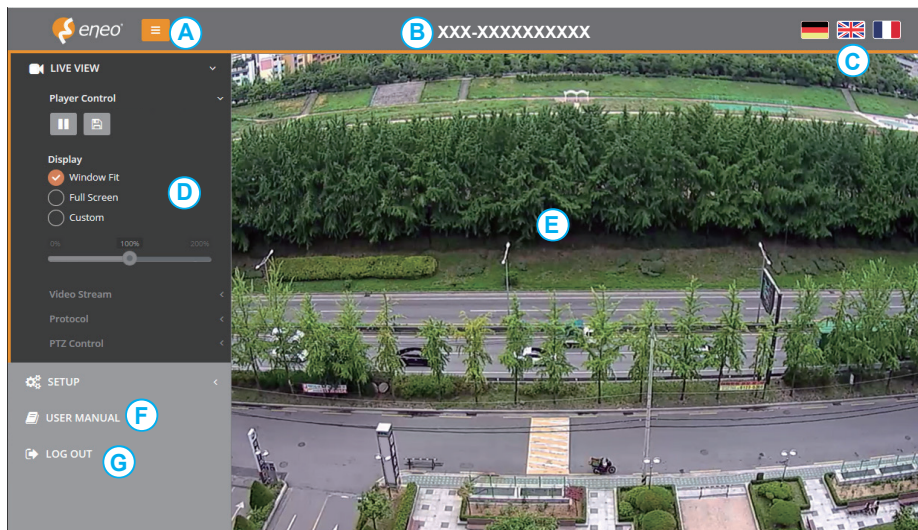

- (A) Menu button : Click the button to show or hide the setup menu bar.
- (B) Model name : Show a camera model name connected.
- (C) Select Language : Set the web viewer language English, Deutsch or French.
- (D) Main setup menu bar : Set the camera or network functions.
- (E) Camera monitoring window: Display the currently connected camera view or function.
- (F) User Manual : Help the menu function.
- (G) Log out and exit the web viewer

# Full Menu Setup

## Setup Menu Table

Category	Menu	Configuration		
LIVE VIEW	Player Control	Pause, Snapshot		
	Display	Window Fit, Full Screen, Custom		
	Video Stream	Stream1, Stream2, Stream3		
	Protocol	HTTP, TCP, UDP		
	PTZ Contol	Zoom, Focus, Push AF		
SETUP	Information	General, System Information, Open source Information		
	Video & Image	Source	Stream1/2/3, Snapshot	
		Image	Basic	Brightness, Contrast, Saturation, Hue, Sharpness, Enable flip image, Enable mirror image
			OSD	Enable text OSD, Enable date&time OSD, Enable zoom&focus OSD, Mode
			AE	Mode, Shutter, Max.Shutter, Gain, Max. gain, Slow shutter, Auto iris, Auto flicker-less
			AWB	Mode, Cb Gain, Cr Gain
			Day&Night	Mode, Switching time, Threshold (D->N), Threshold (N->D), Smart IR
			WDR	WDR(Mode, Level), Defog (Mode)
			BLC	BLC (Mode, Level), HLC (Mode)
			DNR	2DNR(Mode, Level), 3DNR(Mode, Level)
			LDC	Mode, Level, Boundary Line
		VerticalView	Mode, Rotation	
		Privacy Mask	Color, Name	
		Digital Zoom	Level	
		Event	Triggers	Motion, VCA, Tamper, System, Manual, Network, Timer, Day/Night
	Actions		E-Mail, FTP, Video Boost, Notification Server	
	Rules		Event Processing, ONVIF Mapping	
	System	Security	User, HTTPS, IP Filter, ONVIF, Video Stream, Export/Import	
		Date & Time	Current Time, New Time, Time Zone, Date & Time Display	
		Network	TCP/IP, DDNS, RTP, UPnP, Zeroconf, Bonjour	
		Language	English, German, French, Korean, Polish, Finnish	
		Maintenance	Maintain(Restart, Reset, Default), Upgrade, Setup Export, Setup Import	
		Logs & Report	Logs(Database Capacity, Search Condition, Log List), Report	
USER MANUAL				
LOG OUT				

## Full Menu Setup

### 1. LIVE VIEW

Enter the live view menu on the Web Viewer.

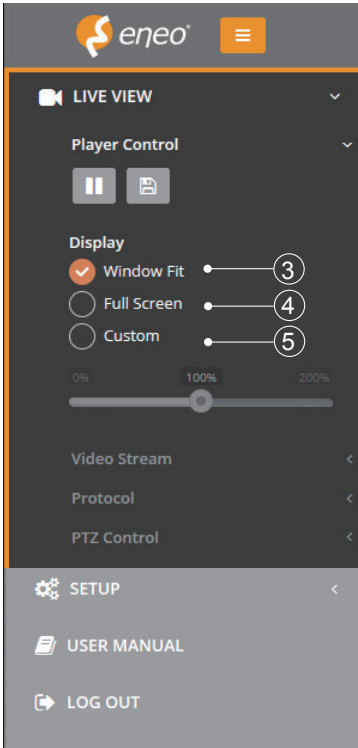

#### ■ Player Control & Display



- ① Pause : Pauses the live view.
- ② Snapshot : Captures the image in .jpg format with the current stream resolution.
- ③ Window Fit : Resizes the live view display to fit along with the display window size.
- ④ Full Screen: Resizes the live view display to fit to the monitor resolution. ESC key returns to the previous view.
- ⑤ Custom : Selects the live view display scale, 0%~200%, by the control bar. 100% is original size.

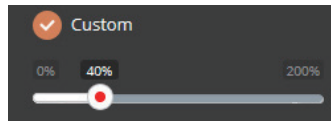

#### ■ Video Stream

Selects the video source stream to display the live view only.

#### ■ Protocol

Selects the network protocol out of HTTP, TCP or UDP.

#### ■ PTZ Control : Not Available



## Full Menu Setup

### 2. SETUP

Enter the setup menu on the Web Viewer.

#### 2-1. Information

Shows the overall information about the system such as Model name, MAC address, IP address, Zeroconf, IP address, Firmware version, Server time, Running time, CPU usage, Inbound/Outbound Bandwidth and Open source list.

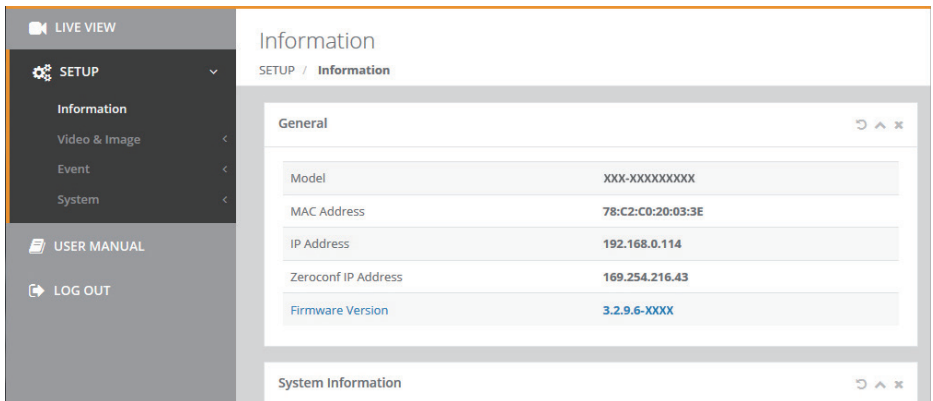

#### 2-2. Video & Image

##### 2-2-1. Source

- **SIGNAL** : Set NTSC/PAL mode depending on TV system. Generally set to NTSC in 60Hz area and PAL in 50Hz area for the electrical power system of your country. Changes will restart the camera.

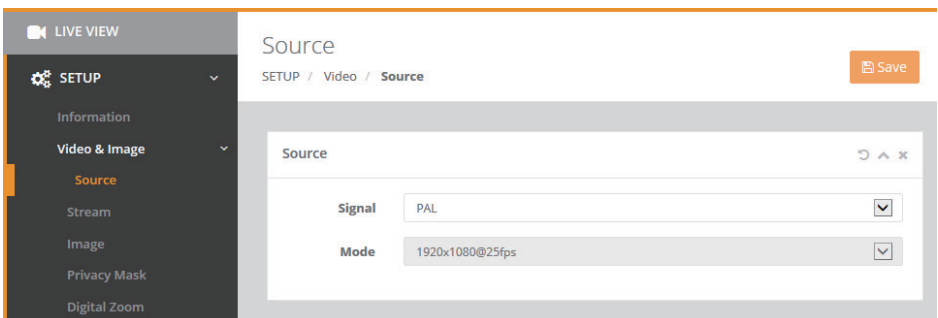

## Full Menu Setup

### 2-2-2. Stream

Stream
Save

SETUP / Video / Stream

Stream1
↶ ↷ ✕

<b>Compression</b>	H.264 High Profile	▼
<b>Resolution</b>	1920x1080	▼
<b>Frame rate</b>	25	▼
<b>GOP size</b>	25	▼
<b>Bitrate control</b>	CBR	▼
<b>Bitrate [Kbps]</b>	4000	▼

#### • **Stream1, 2, 3**

- > **COMPRESSION** : Video compression codecs are available with H.264 profiles for all streams and additional MJPEG for stream3 only.
- > **RESOLUTION** : Each stream can have its individual resolution selected from its list.
- > **FRAME RATE** : Each stream can have its individual frame rate in fps selected from its list.
- > **GOP SIZE**: GOP (Group of Picture) defines the number of Intra-coded pictures (I frame) & Predictive-coded pictures(P frame) in H.264. I frame is a complete image while P frame is the predictive image data which can lower the image data dramatically between frames. GOP SIZE stands for the number of P frames between I frames. Too small GOP SIZE (too frequent I frames) can degrade the picture quality because the codec compresses the data strongly to maintain the bitrate. On the contrary, a little bigger GOP SIZE can improve the picture quality with the better quality for P frames if the network is in good condition. Too big GOP SIZE can make the longer black out or the broken image if the network quality is not good enough.
- > **BITRATE CONTROL** : Selects how to manage the bitrate.
  - **CVBR (Constrained Variable Bit Rate)**:  
Provides the higher image quality with the optimal variable bitrate for the scene which has more moving elements in the image. It is not recommended when network is in heavy duty.
  - **CBR (Constant Bitrate)** :  
Tends to keep the bitrate steady at the assigned bitrate within a very small variation. It is useful when the network is in very heavy use.

## Full Menu Setup

> BITRATE : Indicates the transmission speed through the network and defines the overall picture quality along with the image resolution, frame rate, GOP size and the compression codec for H.264. A high value provides the higher image quality but the total sum of bitrates for the streams has to be considered in calculating the network duty.

### • Snapshot

Capture the video from the camera and create JPEG image files to acquire the image information such as number recognition software.

> Type <http://ip address/cgi-bin/snapshot.jpg> in the address bar and press ENTER.

> Check the setting for capture image resolution:

WEB Viewer→ Log in→ Main Menu→ Setting→ Video&Image→ Video Stream→ Stream3→ Compression: MJPEG (Resolution: 1280x720), Snapshot→ Source : Stream3

※ To maximize the resolution of the captured image, set the Snapshot→ Source to 'Stream1'.

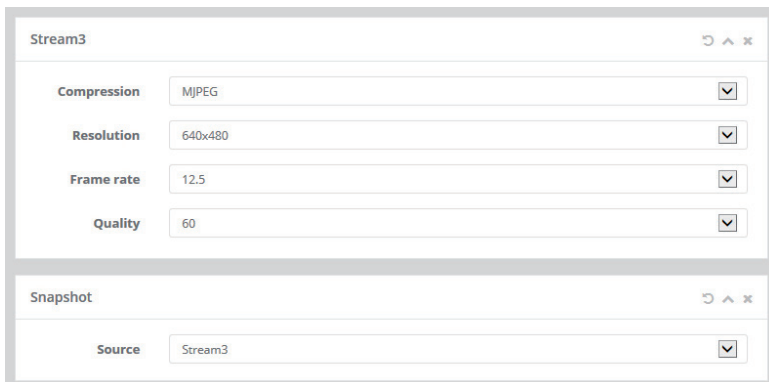

The screenshot shows the 'Stream3' configuration window. It has a title bar with 'Stream3' and window control icons. Below the title bar, there are four rows of settings, each with a label and a dropdown menu:

- Compression:** MJPEG
- Resolution:** 640x480
- Frame rate:** 12.5
- Quality:** 60

Below these settings is a 'Snapshot' section with a title bar and window control icons. It contains one row of settings:

- Source:** Stream3

※ If the error message '401 Unauthorized' pops-up:

WEB Viewer→ Log in→ Main Menu→ Setting→ System→ Security→ Video Stream to disable the check boxes.

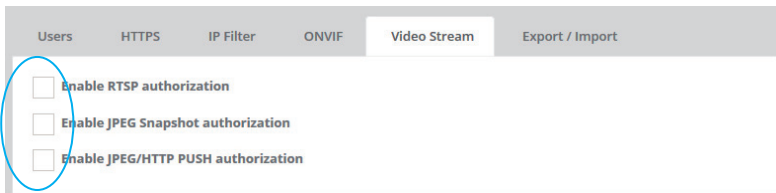

The screenshot shows the 'Security' settings for 'Video Stream'. The 'Video Stream' tab is selected in the top navigation bar. Below the navigation bar, there are three checkboxes, all of which are currently unchecked and circled in red:

- Enable RTSP authorization
- Enable JPEG Snapshot authorization
- Enable JPEG/HTTP PUSH authorization

# Full Menu Setup

## 2-2-3. Image

Success  
This request has been performed without error

Save

Save

Basic OSD AE AWB Day/Night WDR BLC DNR LDC VerticalView

Day

Brightness 8 [Default]

Contrast 8 [Default]

Saturation 9 [Default]

Night

Brightness 8 [Default]

Contrast 8 [Default]

Saturation 9 [Default]

Hue 4 [Default]

Sharpness 5 [Default]

Enable flip image

Enable mirror image

## Full Menu Setup

### ● Basic

- > BRIGHTNESS: Adjusts the overall brightness of the scene. Increasing the value increases the brightness.
- > CONTRAST: Adjusts the contrast of the scene. Increasing the value increases the contrast.
- > SATURATION: Adjusts the color richness of the scene. Increasing the value increases the color richness.
- > HUE: Adjusts the color hue (NTSC only). Decreasing the value produces a greenish hue and increasing the value produces a pinkish hue.
- > SHARPNESS: Adjusts the sharpness of the scene. Increasing the value increases the sharpness.
- > ENABLE FLIP IMAGE : Flips the image on horizontal axis (up and down).
- > EABLE MIRROR IMAGE : Mirrors the image on vertical axis (left and right).

### ● OSD

- > ENABLE TEXT OSD : Enables display of the Text typed in the TEXT field (displays bottom-right).
- > ENABLE DATE&TIME OSD : Enables display of the Date & Time (displays top-left).
- > ENABLE ZOOM&FOCUS OSD : Enables display of the Zoom Ratio & Focusing Mode. (displays top-right). (Applies to Built-in Motor driven V/F lens and AF models only)
- > MODE : Allows you to select when the ZOOM&FOCUS OSD is displayed.
  - ON PUSH: Displays on the OSD for a few seconds whilst lens is adjusting.
  - ALWAYS: Displays on the OSD at all times.

Basic
OSD
AE
AWB
Day/Night
WDR
BLC
DNR
LDC
VerticalView

Enable text OSD

Text

CAM1

Enable date&time OSD

Enable zoom&focus OSD

Mode

On push

▼

**Note**

- The maximum length of OSD text is 16 characters.
- The available OSD characters are alphabet and numeric and + - = : ; , ' ? / ! ` ~ ! @ # \$ \* ( ) [ ] < > { }

## Full Menu Setup

### • AE

- > **MODE** : Selects how to control the exposure, AUTOMATIC or MANUAL.
- > **SHUTTER** : (Available only in MANUAL mode) Sets the shutter to a fixed value.
- > **MAX. SHUTTER** : Sets the maximum exposure time to limit long exposure at night or in low-light scenes.
- > **GAIN** : (Available only in MANUAL mode) Sets the overall video gain.
- > **MAX. GAIN** : Sets the maximum gain that can be automatically reached at night or in low-light scenes.
- > **SLOW SHUTTER** : Extends the shutter time over the maximum shutter at multiple times of value in SLOW SHUTTER. Increasing the values increases brightness but also increases blurriness.
- > **AUTO IRIS** : Engages the mechanical iris of lens to control the amount of incoming light to the sensor.
  - **OFF** : Iris opens and the shutter is engaged to control the video level.
  - **OUTDOOR** : Optimized for the bright scene with the limited shutter speed range.
  - **INDOOR** : Suitable for Indoor use with the fixed shutter speed.
- > **AUTO FLICKERLESS** : Automatically detects and fixes the flickering image under fluorescent lighting caused by the mismatch between NTSC/PAL and 50Hz/60Hz electric power frequency.

Basic	OSD	AE	AWB	Day/Night	WDR	BLC	DNR	LDC	VerticalView	
		<b>Mode</b>	Automatic							▼
		<b>Shutter [sec]</b>	1/1000 [Default]							▼
		<b>Max. Shutter [sec]</b>	1/25 [Default]							▼
		<b>Gain [dB]</b>	10.0 [Default]							▼
		<b>Max. Gain [dB]</b>	36.0 [Default]							▼
		<b>Slow Shutter</b>	Off							▼
		<b>Auto Iris</b>	Off							▼
		<b>Auto Flicker-less</b>	Off							▼

### • AWB

- > **MODE** : Provides White Balance presets. ATW-INDOOR or ATW-OUTDOOR is recommended for most applications.
- > **Cb GAIN / Cr GAIN** : (Available only in MANUAL AWB mode)  
Adjusts the white balance by Cb/Cr color components to the specific lighting which has a fixed color temperature. Not recommended for regular scenes.

## Full Menu Setup

Basic	OSD	AE	AWB	Day/Night	WDR	BLC	DNR	LDC	VerticalView	
				Mode	ATW - Indoor					▼
				Cb Gain	20					▼
				Cr Gain	20					▼

### • Day & Night

- > MODE : Selects how to control the day/night feature.
  - DAY : Disables the switching day/night filter and fixes it to DAY only.
  - NIGHT : Disables the switching day/night filter and fixes it to NIGHT only.
  - AUTOMATIC : Allows the day/night filter to switch via the amount of the incoming light through the lens only. Cameras without the built-in IR LED must select AUTOMATIC.
  - EXTERNAL : Allows the day/night filter to switch via the built-in light sensor only, like a photo sensor. Cameras with the built-in IR LED must select EXTERNAL.
  - COLOR DN [AUTOMATIC] : Produces the color video at night without switching day/night filter. Values in BRIGHTNESS, CONTRAST&SATURATION at SETUP>VIDEO&IMAGE>IMAGE>BASIC>DAY or NIGHT are applied to the scenes for day and night accordingly.
- > SWITCHING TIME : Delays switching the day/night filter to prevent from an undesirable transition.
- > THRESHOLD [D->N] : (Available in AUTOMATIC mode)  
Sets the threshold level for day->night switching. Decrease the value to switch at low luminance.

Basic	OSD	AE	AWB	Day/Night	WDR	BLC	DNR	LDC	VerticalView	
				Mode	External					▼
				Switching Time [sec]	5 [Default]					▼
				Threshold [Day->Night]	46 [Default]					▼
				Threshold [Night->Day]	67 [Default]					▼
				Smart IR	Off					▼
<b>Note</b>										
<ul style="list-style-type: none"> <li>• The "Threshold [Night-&gt;Day]" value must be greater than the value of "Threshold [Day-&gt;Night]" enough to prohibit hunting</li> </ul>										

## Full Menu Setup

> THRESHOLD [N->D] : (Available in AUTOMATIC mode)

Sets the threshold level for night->day switching. Increase the value to switch at high luminance.

[ CAUTION ]

- The gap between THRESHOLD [D->N] and THRESHOLD [N->D] should be greater than 18. Otherwise, an undesirable transition may occur.
  - Too high a value in THRESHOLD [N->D] can cause cameras at installed in low-light areas to stay in night mode permanently i.e. even during daytime.
- > SMART IR : (Available in NIGHT and EXTERNAL modes)  
Helps reduce the highlight saturation at the center of the image caused by strong IR LED illumination. Corners may appear darker instead.

### • WDR

> WDR (Wide Dynamic Range) :

- MODE : ON enhances the dynamic range by the extended adaptive tone reproduction.
- LEVEL : Determines the strength of the dynamic range. Higher values increase brightness.

> DEFOG : Enhances the image contrast automatically against fog.

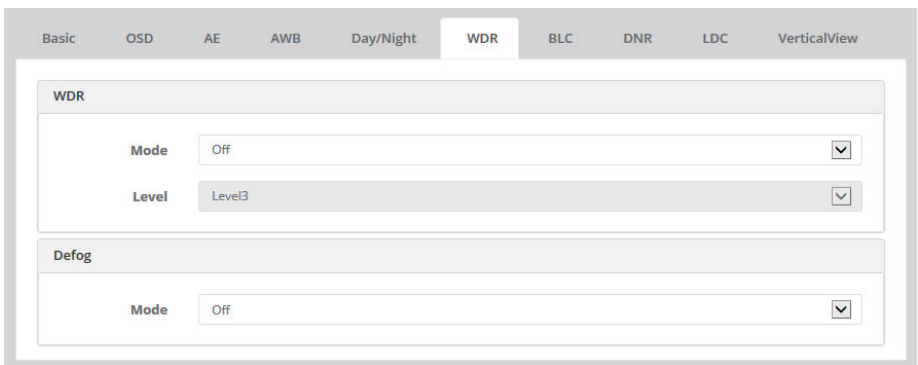

### • BLC

> BLC (Back Light Compensation) :

- MODE : ON enhances the visibility of the back-lit object.
- LEVEL : Determines the strength of the bright-up. High value gets brighter.

> HLC (High Light Compensation) :

ON cuts out the highlight area with black mask and excludes it from compensation.



## Full Menu Setup

Basic   OSD   AE   AWB   Day/Night   WDR   **BLC**   DNR   LDC   VerticalView

**BLC**

Mode:  ▼

Level:  ▼

---

**HLC**

Mode:  ▼

- **DNR** (Dynamic Digital Noise Reduction)

- > 2DNR :

- **MODE**: ON reduces the noise by suppressing the spatial noise components.
- **LEVEL**: Determines the strength of the noise reduction. Higher values reduce more noise but can also lead to loss of detail.

- > 3DNR :

- **MODE**: ON reduces the noise by cancelling the spatial & temporal components in 3 dimensional a way.
- **LEVEL**: Determines the strength of the noise reduction. Higher values reduce more noise but can also lead to a ghosting effect.

Basic   OSD   AE   AWB   Day/Night   WDR   BLC   **DNR**   LDC   VerticalView

**2DNR**

Mode:  ▼

Level:  ▼

---

**3DNR**

Mode:  ▼

Level:  ▼

## Full Menu Setup

- **LDC** (Lens Distortion Compensation)

> **MODE** : ON compensates for the barrel distortion caused by wide angles.

> **LEVEL** : Determines the amount of the compensation. Higher values expand the shrunken areas in the corners.

> **BOUNDARY LINE** : (Available in LDC MODE = OFF)

ON displays left and right boundary lines to show how much distortion occurs.

Basic	OSD	AE	AWB	Day/Night	WDR	BLC	DNR	LDC	VerticalView
								<b>Mode</b>	Off <input type="button" value="v"/>
								<b>Level</b>	42 <input type="button" value="v"/>
								<b>Boundary Line</b>	Off <input type="button" value="v"/>

## Full Menu Setup

### • VerticalView

- > MODE : ON displays the video in vertical view format, 16:9->9:16 for narrow streets, corridors or hallways.
- > ROTATION : Determines the orientation to rotate.

Viewer





Mode : On  
Rotation : 90 degree

Basic
OSD
AE
AWB
Day/Night
WDR
BLC
DNR
LDC
VerticalView

**Mode**

**Rotation**

[View VerticalView video](#)

**Note**

- The VerticalView function is valid on "H.264" video compression.

### 2-2-4. Privacy Mask

Mark ENABLE checkbox to activate the privacy masks.

- > COLOR : Select the color to mask at each privacy area.
- > NAME : Input the individual name for each privacy mask.

## Full Menu Setup

Privacy Mask
⌵ ⌶ ⌷

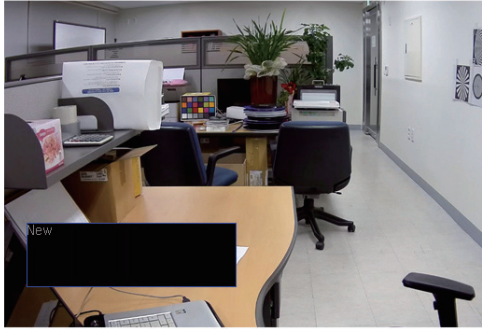

Enable

Color:  ⌵

Name:

ID	Name	Delete
1	New	<input type="button" value="Delete"/>

**Note**

• The position of mask can be changed only if digital zoom and corridor function are inactive

### To set the privacy mask (up to 8 privacy areas) :

- 1) Mark ENABLE checkbox.
- 2) In the video window, place the mouse cursor anywhere and click the right mouse button. A mini pop up appears.  
Select CREATE MASK AREA / DELETE MASK AREA.
- 3) In the video window, place the mouse cursor where you would like to create a mask.  
Click the left-mouse button to create (or delete) a mask. The mask window can be moved or resized with the mouse.
- 4) Enter the name in the list and then click SAVE.

### 2-2-5. Digital Zoom

- > Mark ENABLE checkbox to activate the digital zoom.
- > LEVEL selects the fixed digital zoom ratio. X1.0 is not digital zoomed.

## Full Menu Setup

### 2-3. Event

#### 2-3-1. Triggers

EVENT TRIGGERS menu defines and sets the parameters for the various event sources.

#### [ Important NOTE ]

Once the event is generated, the camera can record the video into the storage, output the alarm signal, email the event, send the video clip to FTP, boost the video frame rate, move to PTZ preset or send the event to the notification server. These post processes require the settings at SETUP>EVENT>ACTIONS first and then SETUP>EVENT>RULES.

#### ● **Motion :**

- > Mark ENABLE checkbox to create & activate up to 4 motion areas.
- > NAME : Input the individual name for each motion detection area.
- > SENSITIVITY: Sets the motion detection sensitivity for all areas. Higher values increase sensitivity
- > DWELL : Sets the time for the motion event once detected.

LIVE VIEW

SETUP

Information

Video & Image

Event

Triggers

Actions

Rules

System

USER MANUAL

LOG OUT

### Triggers

SETUP / Event / Triggers Save

Motion    VCA    Tamper    System    Manual    Network    Timer    Day/Night



Enable

Name:

Sensitivity:

Dwell [sec]:

ID	Name	Type	Dwell	Delete
1	default	Include	3	Delete

## Full Menu Setup

To set the motion detection area (up to 4 include-types and 4 exclude-types) :

- 1) Mark ENABLE checkbox.
- 2) In the video window, place the mouse cursor where you would like to make a detection window and click&drag the right button. The following window is then generated.
  - INCLUDE-Type : defines areas where motion should be detected.
  - EXCLUDE-Type : defines areas within a window that should be ignored.
- 3) Enter a name and then click SAVE.

### [ NOTE ]

Motion detection and VCA cannot be used simultaneously. If either one is enabled, the other one is disabled automatically.

### ● **VCA** (Video Contents Analysis)

- > Mark ENABLE checkbox to create & activate up to 3 VCAs(Line Cross & Field Intrusion).
- > NAME : Input the individual name for each VCA.
- > DIRECTION : (Line Cross only) Sets the direction of detection for the line cross.
  - TWO WAY : Detects the line cross in either way.
  - CW : Detects the line cross when crossed the line in the direction of arrow.
  - CCW : Detects the line cross when crossed the line in the direction of arrow.
- > COUNT : (Line Cross only) Displays the number of the object detections by the line cross detector.
- > RESET : Resets the count number.
- > DWELL : Sets the time for the event once detected.

To set the VCA detection area (up to total 3 VCAs including Line Cross & Field Intrusion) :

- 1) Mark ENABLE checkbox.
- 2) Click the mouse right button on the video viewer and a popup menu appears.
  - CREATE VCA DETECTOR : Select to create the VCA type, up to 3 VCAs.
  - LINE CROSS : Detects an object crossing the virtual line for the line cross detection.
  - FIELD INTRUSION : Detects objects entering or leaving the defined virtual window.
  - CREATE MASKING AREA : Select to create the masking area which will exclude the detection.
  - DELETE VCA DETECTOR : Deletes the existing VCA window. VCAs can be deleted at the list too.
  - DELETE MASKING AREA : Deletes the existing VCA mask window.
- 3) Enter a name and then click SAVE.

### [ NOTE ]

Motion detection and VCA cannot be used simultaneously. If either one is enabled, the other one is disabled automatically.

# Full Menu Setup

## Triggers

SETUP / Event / Triggers

Save

ID	Name	Detector	Direction	Count	Dwell	Delete
1	New1	Line cross	CW	28	3	Delete

### > OBJECT SETTING:

Click the green rotating icon on the top-right of the video window and OBJECT SETTING menu will appear. To hide it, click the icon again.

Mark SHOW OBJECT SIZE checkbox and a black rectangle at the top-left corner of the video window will appear. The black rectangle is the reference size which shows the minimum (white box) & maximum (black box) detecting size of the object. To adjust the minimum (or maximum) object size to be detected, adjust the left (right) ends of the slide bars, WIDTH & HEIGHT, by moving them with clicking and holding the left mouse button. Objects can be detected only for the object size set between minimum and maximum, that is, an object which is smaller than minimum or greater than maximum can't be detected. Too small value in MINIMUM or too big value in MAXIMUM for the object size might increase the erroneous detections.

## Full Menu Setup

- SENSITIVITY : Sets the detection sensitivity for the objects.
- WIDTH : Sets the minimum/maximum sizes in width of the objects to be detected.
- HEIGHT : Sets the minimum/maximum size in height of the objects to be detected.
- SHOW OBJECT SIZE : Shows the reference size of detection object.

### • **Tamper**

The camera can detect severe changes in the image caused by actions such as repositioning the camera or painting over of the lens and generates an alarm to alert.

- > Mark ENABLE checkbox to activate the tamper alarm.
- > DWELL TIME : Sets the time for the tamper alarm once detected.

### • **System**

Used to trigger the event when the camera gets rebooted.

- > Mark ENABLE checkbox to activate the system event.
- > DWELL TIME : Sets the time for the alarm once the system event is detected.

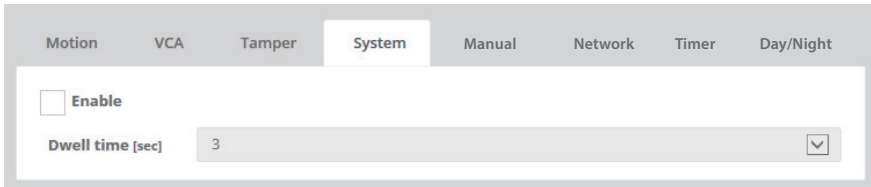

The screenshot shows the 'System' configuration menu. At the top, there are tabs for Motion, VCA, Tamper, System (selected), Manual, Network, Timer, and Day/Night. Below the tabs, there is an 'Enable' checkbox which is currently unchecked. Below the checkbox is a 'Dwell time [sec]' field with a dropdown menu showing the value '3'.

### • **Manual :**

Enables to user to set the event trigger optionally.

- > Mark ENABLE checkbox to enable the manual trigger icons on the live view menu.
- > DWELL TIME : Sets the time for the event once triggered by the manual trigger on the live view menu.

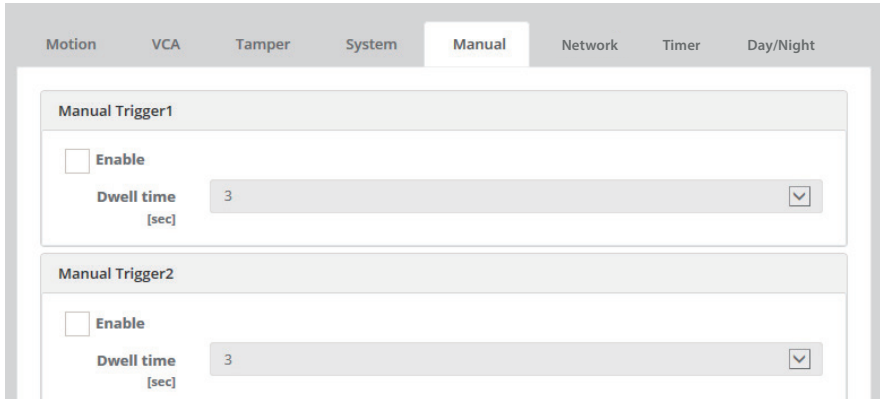

The screenshot shows the 'Manual' configuration menu. At the top, there are tabs for Motion, VCA, Tamper, System, Manual (selected), Network, Timer, and Day/Night. Below the tabs, there are two sections for manual triggers. The first section is 'Manual Trigger1' and the second is 'Manual Trigger2'. Each section has an 'Enable' checkbox which is currently unchecked. Below each checkbox is a 'Dwell time [sec]' field with a dropdown menu showing the value '3'.



## Full Menu Setup

### • Network :

Used to trigger the event when the network connection fails.

> Mark ENABLE checkbox to activate the network event.

> DWELL TIME : Sets the time for the event once triggered by the network connection event.

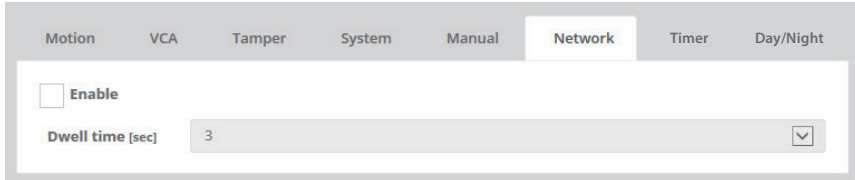

Motion VCA Tamper System Manual **Network** Timer Day/Night

Enable

Dwell time [sec] 3

### • Timer

Mark ENABLE checkbox to trigger the event as defined Timer Interval.

(Hour/Minute/Second)

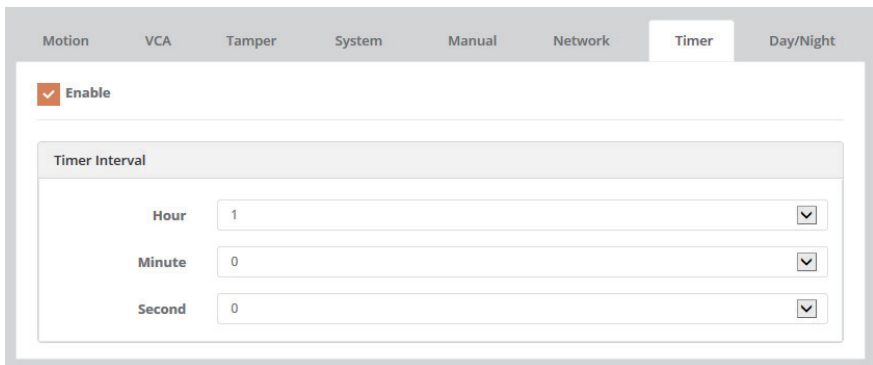

Motion VCA Tamper System Manual Network **Timer** Day/Night

Enable

Timer Interval

Hour 1

Minute 0

Second 0

### • Day / Night

Mark ENABLE checkbox to trigger the event when Day/Night is switched.

> MODE : Select the mode, Day->Night or Night->Day.

> DWELL TIME : Sets the interval duration for the alarm event.

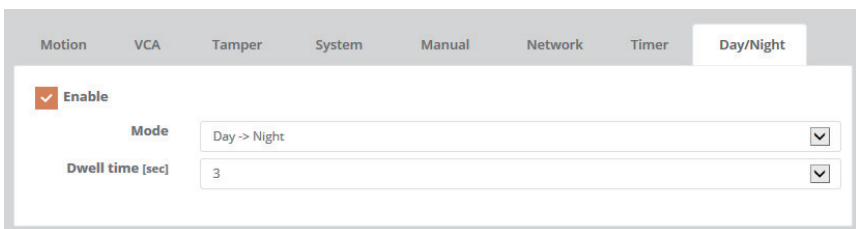

Motion VCA Tamper System Manual Network Timer **Day/Night**

Enable

Mode Day -> Night

Dwell time [sec] 3

## Full Menu Setup

### 2-3-2. Actions

EVENT ACTIONS menu defines and sets the parameters for how to treat the various event sources.

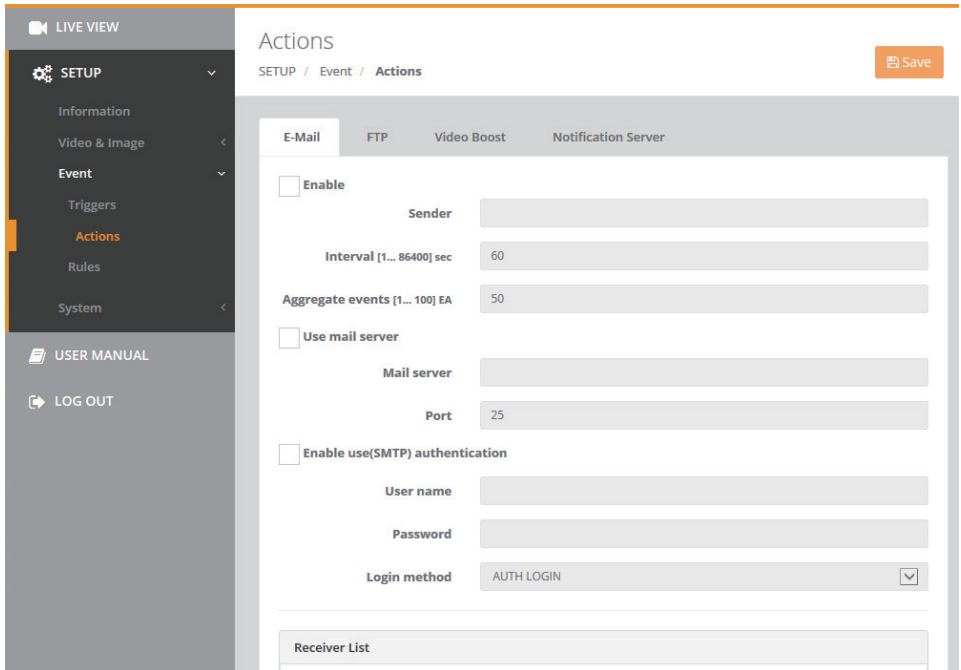

#### • **E-mail**

The camera can send email messages generated by the events via SMTP (Simple Mail Transfer Protocol).

> Mark ENABLE checkbox to enable emailing.

- SENDER : Enter the email address as the sender. Any virtual email address like sample@sample.com can be used if the recipient can recognize it from the camera.
- INTERVAL : Sets the interval for emailing after the events occur.
- AGGREGATE EVENTS : Sets the number of events which will be sent in an email.

> Mark USE MAIL SERVER checkbox to set the mailing server.

- MAIL SERVER : Enter the host name or IP addresses for the mail servers. If a host name is used, a valid DNS server must be specified in the Network-Basic settings.
- PORT : Enter the port number of the mail server.

> Mark ENABLE USE(SMTP) AUTHENTICATION checkbox if the mail server requires authentication.

## Full Menu Setup

- **USER NAME** : Enter the user name as provided by the network administrator.
- **PASSWORD** : Enter the password as provided by the network administrator.
- **LOGIN METHOD** : Select one for SMTP authentication method allowed.

**[ NOTE ]**

If a PLAIN or LOGIN mechanism is negotiated, the camera sends the user name and password to the SMTP server. The LOGIN mechanism is supported by Microsoft, as well as some other clients. Most other clients support the PLAIN authentication mechanism. Since the vast majority of Email clients support only PLAIN or LOGIN, mail server administrators will probably want to consider using STARTTLS to provide an encryption "tunnel" between the client and server to protect the user name and password.

- > **RECEIVER LIST** : Enter the recipient's email addresses as the receivers.
- > **E-MAIL(SMTP) TEST** : Enter the recipient's email address in RECEIVER and click the TEST button to test if the mail servers are functioning and the email address is valid.

● **FTP**

FTP notification will save files on the specified FTP server.

E-Mail
FTP
Video Boost
Notification Server

Enable

**Server**

**Port**

**Remote directory**

**User name**

**Password**

Passive mode

Anonymous login

**JPEG Setting**

**Pre-event**  [sec]     [fps]

**Post-event**  [sec]     [fps]

**Prefix file name**

**Additional suffix**     None     Date&Time     Sequence number

## Full Menu Setup

- > Mark ENABLE checkbox to set the FTP server.
  - SERVER : Enter the IP address or host name of the specific FTP server.
  - PASSIVE MODE : Under normal circumstances the network camera simply requests the target FTP server to open the data connection. Checking this box issues a PASV command to the FTP server and establishes a passive FTP connection; whereby the network camera actively initiates both the FTP control and data connections to the target server. This is normally desirable if there is a firewall between the network camera and the target FTP server.
  - PORT : Enter the port number used by the FTP server. The port number can be adjusted in the range 1-65535. The default setting is 21.
  - REMOTE DIRECTORY: Specify the path to the directory where the uploaded images will be stored. If this directory doesn't already exist on the FTP server, an error message shows up when uploading.
  - USER NAME: Enter the user name provided by the network administrator.
  - ANONYMOUS LOGIN: Mark ANONYMOUS LOGIN checkbox if anyone is permitted to access the FTP server.
  - PASSWORD: Enter the password provided by the network administrator.
  
- > JPEG SETTING : Configures JPEG for the FTP server.
  - PRE-EVENT : Sets the time & the frame rate for JPEG images to be sent to FTP before the event.
  - POST-EVENT : Sets the time & the frame rate for JPEG images to be sent to FTP after the event.
  - PREFIX FILE NAME : Input the prefix for JPEG image file names to be sent to FTP.
  - ADDITIONAL SUFFIX : Selects the suffix for JPEG image file names to be added after the file name. Selecting NONE will overwrite the previous file and thus DATE & TIME is most preferable.

## Full Menu Setup

### • Video Boost

Sets the frame rate and bitrate for H.264 stream and the quality for JPEG stream at EVENT STATE when the event occurs.

**[ NOTE ]** Video boost is disabled during SD recording.

E-Mail	FTP	Video Boost	Notification Server
<b>Video Boost 1</b>			
<input type="checkbox"/> Enable			
	<b>Normal State</b>	<b>Event State</b>	
Frame rate	25	25	▼
Bitrate	4000	4000	▼
<b>Video Boost 2</b>			
<input type="checkbox"/> Enable			
	<b>Normal State</b>	<b>Event State</b>	
Frame rate	25	25	▼
Bitrate	2000	2000	▼
<b>Video Boost 3</b>			
<input type="checkbox"/> Enable			
	<b>Normal State</b>	<b>Event State</b>	
Quality	60	60	▼

## Full Menu Setup

### • Notification Server

- > Mark ENABLE checkbox to notify the event to the notification server when it occurs.
  - TYPE : Selects the network protocol to connect the notification server.
  - SERVER URL : Input the server URL of the notification sever. To enable the audio when the event occurs, copy the URL at SETUP>AUDIO and paste it on the server URL like `http://x.x.x.x/setup/audio/audio.php`
  - USERNAME : Enter the username (default : admin)
  - PASSWORD : Enter the password (default : admin)
- > NOTIFICATION TEST: Input the test message and click TEST button.

#### [ NOTE ]

There could be several event actions like FTP, e-mail etc. For detailed URL per event actions, refer to API documents. In case Notification server is set as event rule, the same URL from Notification Test should be entered in RULE>ADD>NOTIFICATION SERVER.

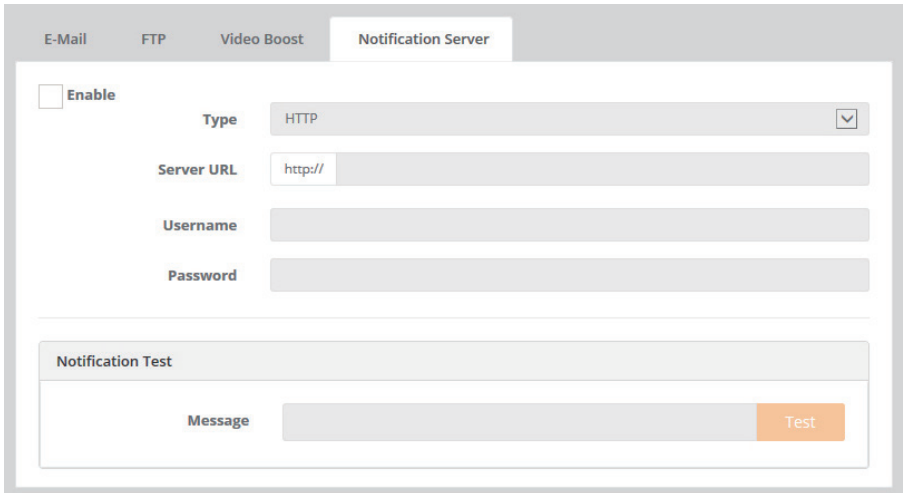

The screenshot shows a web interface for configuring a Notification Server. At the top, there are four tabs: E-Mail, FTP, Video Boost, and Notification Server (which is selected). Below the tabs, there is a section for enabling the notification server. It starts with an 'Enable' checkbox. To the right, there are four input fields: 'Type' (a dropdown menu showing 'HTTP'), 'Server URL' (a text field with 'http://' entered), 'Username' (an empty text field), and 'Password' (an empty text field). Below this section is a 'Notification Test' section, which contains a 'Message' text field and a 'Test' button.

## Full Menu Setup

### 2-3-3. Rules

EVENT RULES menu defines and sets the parameters for what to do for the various event sources.

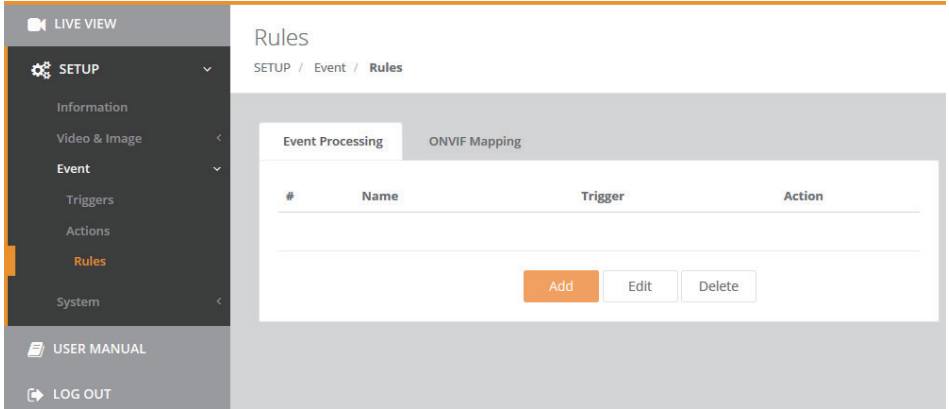

#### • **Event Processing**

Event process lists have to be generated and can be edited for what to do when the event occurs. List shows the rule name, trigger source and type of action for each event process. To edit or delete the rule in the list, click the listed line and then click EDIT or DELETE button.

#### **ADDING & EDITING RULES**

> NAME : Input the rule name which is descriptive to the rule.

#### **EVENT TRIGGER**

> TYPE : Select the type of the event source.

> AND : Mark ENABLE checkbox to trigger the event when two TYPES of event occur within the defined dwell time of the individual events.

#### **EVENT ACTION**

> E-MAIL :

- Input the email addresses to be emailed.
- Mark the checkbox for the email addresses to be emailed as set in SETUP>EVENT> ACTIONS>E-MAIL when the selected event occurs
- SUBJECT of email is a required field and ADDITIONAL INFO is optional to input.

> NOTIFICATION SERVER: Mark the checkbox to use the notification server as set in SETUP>EVENT> ACTIONS> NOTIFICATION SERVER when the selected event occurs.

- MESSAGE : Input the message to be sent to the notification server.

## Full Menu Setup

- > FTP : Mark the checkbox to use FTP as set in SETUP>EVENT>ACTIONS>FTP when the selected event occurs.
- > VIDEO BOOST : Select the video stream to be boosted up.  
[ NOTE ] Video boost is disabled if RECORD is enabled.

### Add Rule

Name

---

**Event Trigger**

Type   **AND**

---

**Event Action**

**E-Mail**

<input type="checkbox"/> Address1	<input type="text"/>	<input type="checkbox"/> Address2	<input type="text"/>
<input type="checkbox"/> Address3	<input type="text"/>	<input type="checkbox"/> Address4	<input type="text"/>
<input type="checkbox"/> Address5	<input type="text"/>	<input type="checkbox"/> Address6	<input type="text"/>
<input type="checkbox"/> Address7	<input type="text"/>	<input type="checkbox"/> Address8	<input type="text"/>

Subject

Additional info

---

**Notification Server**

Message

---

**FTP**

---

**Video Boost**    Video1    Video2    Video3



## Full Menu Setup

### • *ONVIF Mapping*

Onvif mapping is provided to map the various events generated by this camera, but not defined by Onvif, to assign them to Onvif events for the Onvif compatible VMSEs or NVRs. Two mappings for Motion and Alarm In are provided to be mapped and can be used by editing them.

For example, any of the selected items in tns1:VideoSource/MotionAlarm will notify the Onvif compatible VMSEs or NVRs as Motion Alarm. In the same way, any of the selected items in tns1: Device/Trigger/Digital Input will notify the Onvif compatible VMSEs or NVRs as Alarm IN.

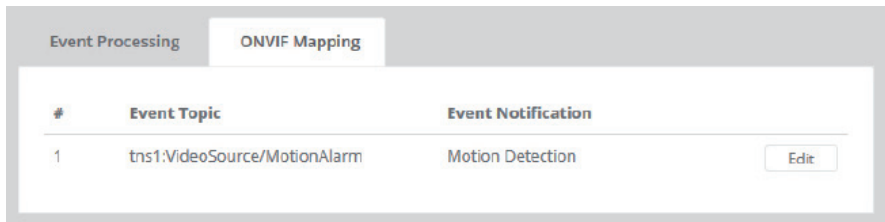

#	Event Topic	Event Notification	
1	tns1:VideoSource/MotionAlarm	Motion Detection	<input type="button" value="Edit"/>

# Full Menu Setup

## 2-4. System

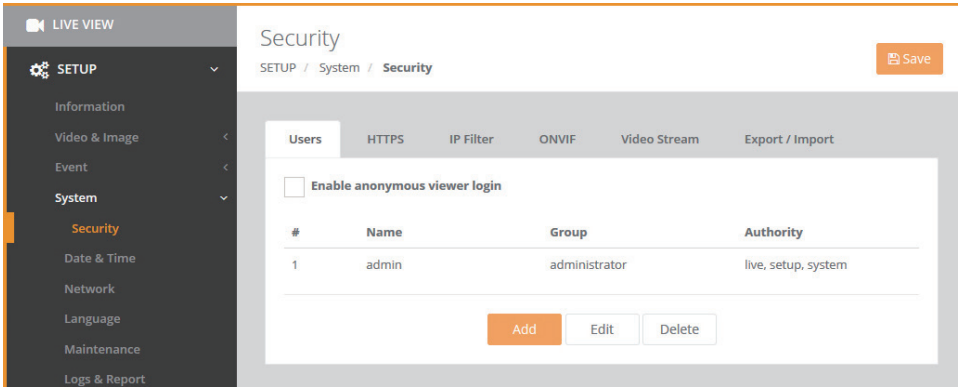

The screenshot shows the 'Security' configuration page. On the left is a dark sidebar with 'LIVE VIEW' at the top and 'SETUP' below it. Under 'SETUP', there are several menu items: Information, Video & Image, Event, System (expanded), Security (highlighted in orange), Date & Time, Network, Language, Maintenance, and Logs & Report. The main content area is titled 'Security' and has a breadcrumb 'SETUP / System / Security'. A 'Save' button is in the top right. Below the title are tabs for 'Users', 'HTTPS', 'IP Filter', 'ONVIF', 'Video Stream', and 'Export / Import'. The 'Users' tab is active, showing a checkbox for 'Enable anonymous viewer login' and a table of users.

#	Name	Group	Authority
1	admin	administrator	live, setup, system

At the bottom of the table are three buttons: 'Add', 'Edit', and 'Delete'.

### 2-4-1. Security

#### • Users

Manages the user accounts by names, groups and authorities.

- > Mark ENABLE ANONYMOUS VIEWR LOGIN if anyone is permitted to login anonymously. Accessing SETUP menu with the anonymous login will exit and require ID/Password login.
- > USERS : Can be added, edited or deleted.

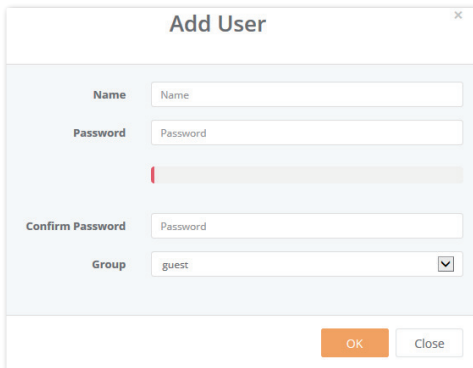

The 'Add User' dialog box contains the following fields:

- Name: Text input field with placeholder 'Name'.
- Password: Text input field with placeholder 'Password'.
- Confirm Password: Text input field with placeholder 'Password'.
- Group: Dropdown menu with 'guest' selected.

Buttons: 'OK' (orange) and 'Close' (white).

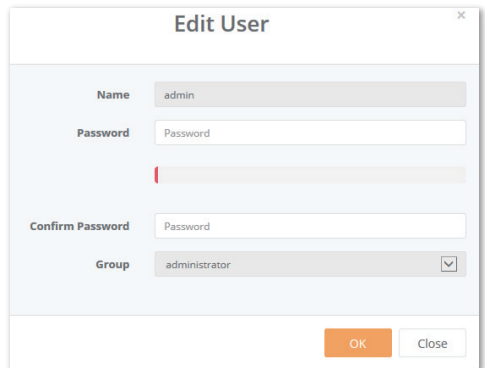

The 'Edit User' dialog box contains the following fields:

- Name: Text input field with 'admin' pre-filled.
- Password: Text input field with placeholder 'Password'.
- Confirm Password: Text input field with placeholder 'Password'.
- Group: Dropdown menu with 'administrator' selected.

Buttons: 'OK' (orange) and 'Close' (white).

## Full Menu Setup

### • HTTPS

Selects the CONNECTION MODE.

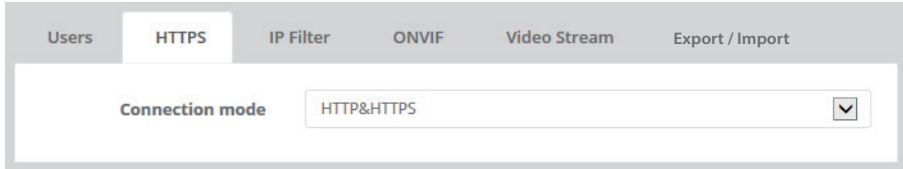

Users | **HTTPS** | IP Filter | ONVIF | Video Stream | Export / Import

Connection mode: HTTP&HTTPS

- > HTTP : Transfers data without encryption. Supports a URL that only starts with "HTTP: "
- > HTTPS : Transfer data with encryption by Hypertext Transfer Protocol over SSL protocol. Supports a URL that only starts with "HTTPS: "
- > HTTP&HTTPS : Supports both HTTP and HTTPS protocols.

#### [ NOTE ]

To ensure security on the internet, all web browsers provide several security levels that can be adjusted for sites that use SSL (Secure Socket Layer) technology to transfer data. SSL encrypts communications, making it difficult for unauthorized users to intercept and view user names and passwords. SSL requires signed certificates to determine if the web browser accessing the camera has the required authentication. This camera can generate a self-signed certificate using Open SSL.

### • IP Filter

- > Mark ENABLE IP ADRESS FILTERING to filter the IP addresses.
- > Mark ON/OFF for the IP address range to use IP filtering.
- > Select ALLOW or DENY to permit or filter out the IP address range.
- > Input the IP address ranges with START IP and END IP.

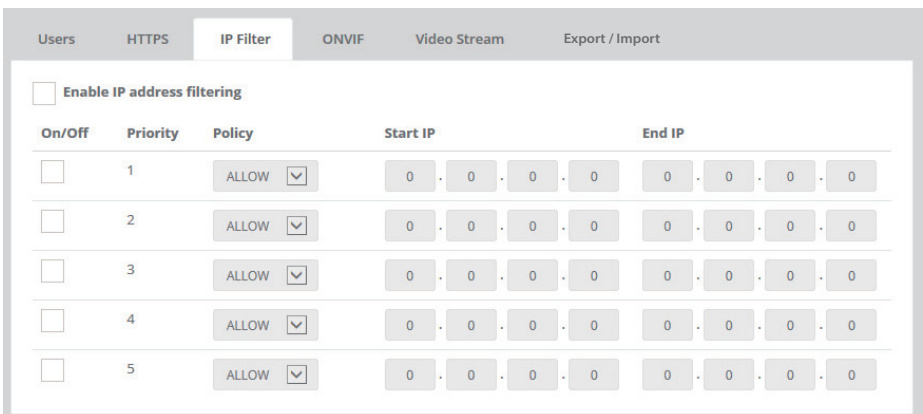

Users | HTTPS | **IP Filter** | ONVIF | Video Stream | Export / Import

Enable IP address filtering

On/Off	Priority	Policy	Start IP	End IP
<input type="checkbox"/>	1	ALLOW	0 . 0 . 0 . 0	0 . 0 . 0 . 0
<input type="checkbox"/>	2	ALLOW	0 . 0 . 0 . 0	0 . 0 . 0 . 0
<input type="checkbox"/>	3	ALLOW	0 . 0 . 0 . 0	0 . 0 . 0 . 0
<input type="checkbox"/>	4	ALLOW	0 . 0 . 0 . 0	0 . 0 . 0 . 0
<input type="checkbox"/>	5	ALLOW	0 . 0 . 0 . 0	0 . 0 . 0 . 0

## Full Menu Setup

[ **NOTE** ] To add a subnet of network addresses, these must be added in CIDR (Classless Inter-Domain Routing) notation. For example: entering 192.168.1.0/24 will add all the addresses in the range 192.168.1.1 to 192.168.1.254. Contact your network administrator for more detail. If the network camera is accessed via a proxy server, the IP address for the proxy server must be added as an allowed address.

### • **ONVIF**

> Mark **ENABLE WS SECURITY** to provide the ONVIF compliance.

### • **Video Stream**

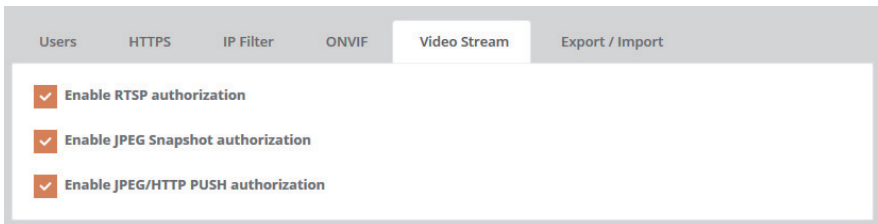

Users    HTTPS    IP Filter    ONVIF    **Video Stream**    Export / Import

- Enable RTSP authorization
- Enable JPEG Snapshot authorization
- Enable JPEG/HTTP PUSH authorization

> **ENABLE RTSP AUTHORIZATION** : If marked, the authorization is required when the stream 1/2/3 is accessed using RTSP.

> **ENABLE JPEG SNAPSHOT AUTHORIZATION** : If marked, the authorization is required when the Jpeg snapshot image is requested.

> **ENABLE JPEG/HTTP PUSH AUTHORIZATION** : If marked, the authorization is required when the Jpeg/HTTP PUSH image is requested.

### • **Export / Import**

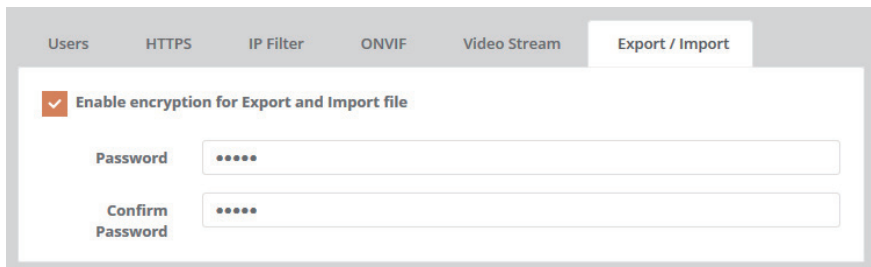

Users    HTTPS    IP Filter    ONVIF    Video Stream    **Export / Import**

- Enable encryption for Export and Import file

Password:

Confirm Password:

> Mark **ENABLE ENCRPTION FOR EXPORT AND IMPORT FILE** :

System configuration file, which is exported at **SETUP>SYSTEM>MAINTENANCE>SETUP EXPORT**, is encrypted with the password herein.

[ **NOTE** ] **THIS PASSWORD MUST BE USED** when System configuration file is imported by other cameras if the file was exported with the password.

> If the checkbox is not marked, system configuration file is exported without encryption.

## Full Menu Setup

### 2-4-2. Date & Time

#### • **Current Time**

Shows the current date and time. Clicking SAVE tap updates and saves the date and time with the selected time in NEW TIME.

#### • **New Time**

Select one of the following server times.

- > SYNCHRONIZE WITH COMPUTER TIME : Obtains the time from the computer.
- > SET MANUALLY : Sets the date and time manually.
- > SYNCHRONIZE WITH NTP SERVER : Obtains the time from the assigned NTP server at every hour in INTERVAL. The NTP server's IP address or host name has to be specified in the time server.

#### • **Time Zone**

Select the time zone to be referenced to the NTP server where the camera is installed. Mark AUTOMATICALLY ADJUST FOR DAYLIGHT SAVING CHANGES check box to update the time automatically with daylight savings.

#### • **Date & Time Display**

Select the date & time formats to be displayed.

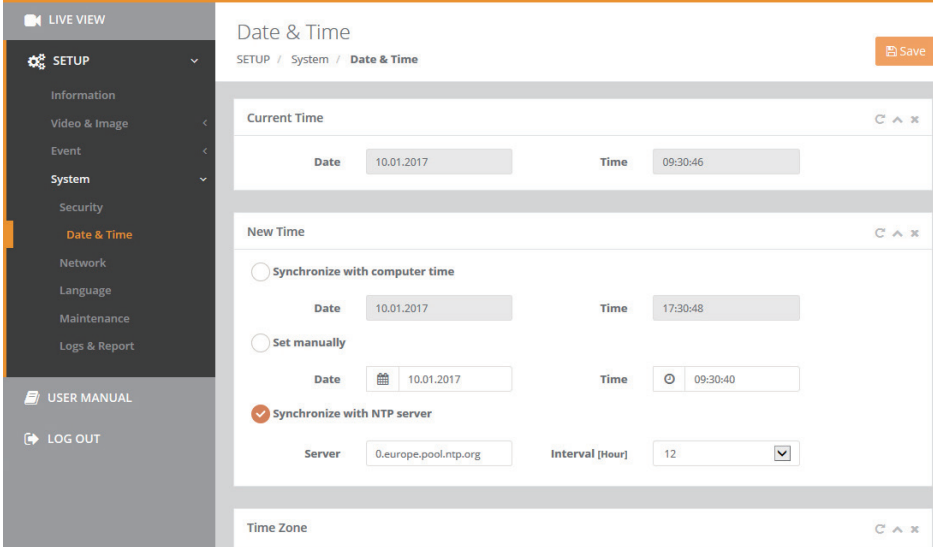

The screenshot shows the 'Date & Time' configuration screen. On the left is a sidebar menu with 'Date & Time' highlighted. The main area has a breadcrumb 'SETUP / System / Date & Time' and a 'Save' button. It features three sections: 'Current Time' with input fields for Date (10.01.2017) and Time (09:30:46); 'New Time' with three radio button options: 'Synchronize with computer time', 'Set manually', and 'Synchronize with NTP server' (which is selected). The 'Synchronize with NTP server' option includes fields for 'Server' (0.europe.pool.ntp.org) and 'Interval [Hour]' (12). At the bottom is a 'Time Zone' section.

## Full Menu Setup

### 2-4-3. Network

#### • TCP/IP

##### > IPv4 ADDRESS :

- OBTAIN IP ADDRESS VIA DHCP : Gets the IP address assigned by the DHCP (Dynamic Host Configuration Protocol) server.
- STATUS : 'Allocated' shows that the IP address is obtained from the DHCP.
- IP ADDRESS, SUBNET MASK, GATEWAY : Displays the current IP address which is obtained from the DHCP.
- USE THE FOLLOWING ADDRESS : Requires the input of a static IP address manually.

##### > IPv6 ADDRESS : Mark ENABLE check box to use IPv6 address and click SAVE button, then new IPv6 address will be obtained.

##### > DNS :

- OBTAIN DNS ADDRESS VIA DHCP SERVER : Obtains the DNS address automatically assigned by DHCP server.
- USE THE FOLLOWING DNS ADDRESS : Requires manual input as per below.
  - DOMAIN NAME : Enter the domain for the host name
  - PRIMARY DNS SERVER : Enter the IP address of the primary DNS server.
  - SECONDARY DNS SERVER : Enter the IP address of the secondary DNS server.

##### > HOSTNAME : This camera can be accessed using a host name instead of an IP address. The host name is usually the same as the assigned DNS name.

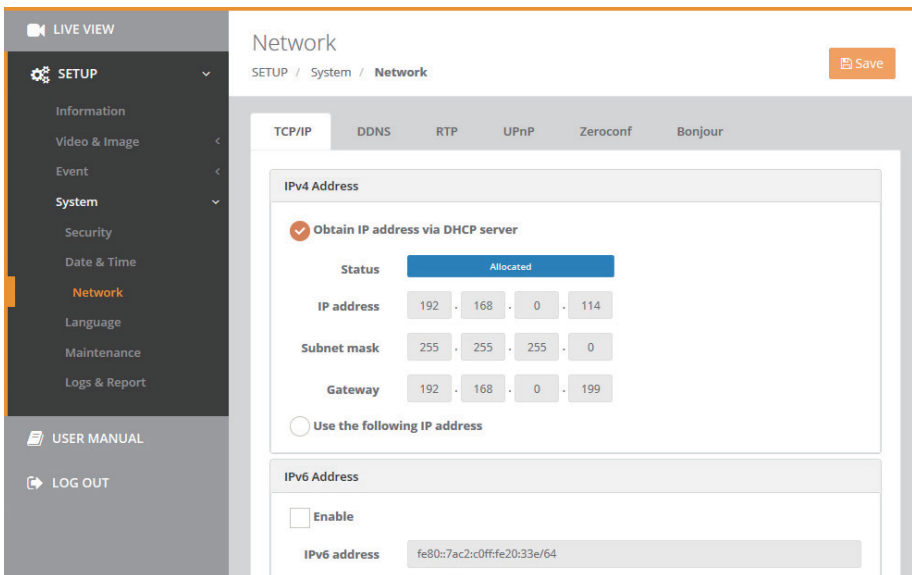

The screenshot shows the 'Network' configuration page. On the left is a sidebar with 'LIVE VIEW', 'SETUP', and 'USER MANUAL' sections. The 'SETUP' section is expanded to show 'System' and 'Network'. The 'Network' section is selected, and the 'TCP/IP' tab is active. The 'IPv4 Address' section is expanded, showing the 'Obtain IP address via DHCP server' option selected. The status is 'Allocated'. The IP address is 192.168.0.114, the subnet mask is 255.255.255.0, and the gateway is 192.168.0.199. The 'Use the following IP address' option is unselected. The 'IPv6 Address' section is also expanded, showing the 'Enable' checkbox unselected and the IPv6 address fe80::7ac2:c0ff:fe20:33e/64.

## Full Menu Setup

**IPv6 Address**

Enable

IPv6 address

---

**DNS**

Obtain DNS address via DHCP server

Use the following DNS address

Domain name

Primary DNS  .  .  .

Secondary DNS  .  .  .

---

**Hostname**

Hostname

---

**Port**

HTTP port

HTTPS port

RTSP port

> PORT :

- HTTP PORT : Use a port number in the range 1024-65535. Default is 80.
- HTTPS PORT : Use a port number in the range 1024-65535. Default is 443.
- RTSP PORT : Use a port number in the range 1024-65535. Default is 554.

## Full Menu Setup

- **DDNS** (Dynamic Domain Naming Service)

> Mark ENABLE checkbox to use DDNS.

> DDNS server : Select the DDNS server to use.

> Input REGISTERED HOST name, USER NAME, PASSWORD and INTERVAL.

**[ NOTE ]**

If the camera has not been registered to the DDNS host previously, the registration is required. If the camera is already registered but its IP address changes, the DDNS must be updated with this new IP address. It will update at a regular interval.

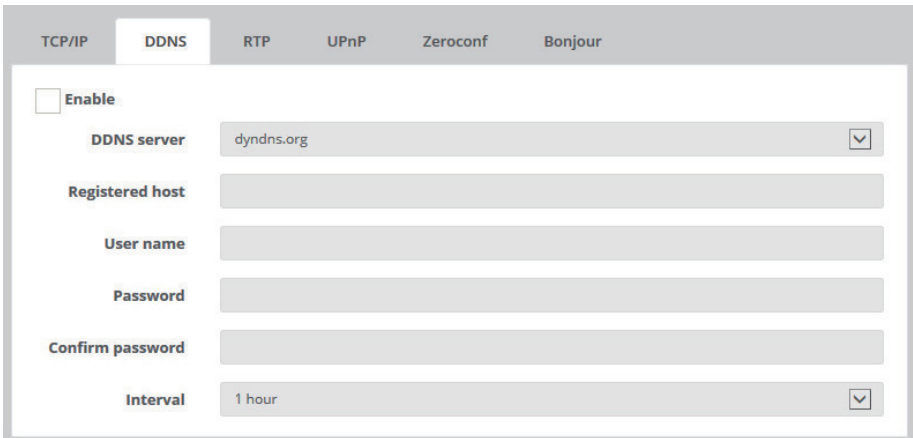

The screenshot shows a web interface for configuring DDNS. At the top, there are tabs for TCP/IP, DDNS, RTP, UPnP, Zeroconf, and Bonjour. The DDNS tab is selected. Below the tabs, there is a checkbox labeled "Enable" which is currently unchecked. Below the checkbox, there are several input fields: "DDNS server" with a dropdown menu showing "dyndns.org", "Registered host", "User name", "Password", "Confirm password", and "Interval" with a dropdown menu showing "1 hour".



## Full Menu Setup

### • RTP

- > **START PORT & END PORT** : RTP port range defines the range of the ports from which ports of the video/audio are automatically selected. This feature is useful if the camera is connected to a NAT router with manually configured port mapping. Limit the range of the ports permitted for RTP unicast/multicast by entering **START PORT** and **END PORT**.
- > **MULTICAST - STREAM1, 2, 3** : Only IP addresses within certain ranges can be used for multicasting. The camera has been pre-configured with addresses from these ranges and does not normally need to be reconfigured. If an address needs to be changed, please contact the network administrator.
  - Mark **ENABLE** checkbox to use the multicast for each stream.
  - **DESTINATION IP**: Type IP address in the range. Multicast addresses are allocated according to these IANA policies.
  - **PORT** : Use the port number in the range 1024-65532. Default is 4000.
  - **TTL** : When IP packets or data fails to be delivered to the destination within TTL (Time To Live), this setting tells the network router when to discard the packet. The value is usually measured in 'hops', i.e. the number of network routers that can be passed before the packet arrives at its destination or is dropped.

TCP/IP	DDNS	RTP	UPnP	Zeroconf	Bonjour
<b>Start port</b>		<input type="text" value="30000"/>	[30000... 39800; Only even values are available]		
<b>End port</b>		<input type="text" value="30199"/>			
<b>Multicast - Stream 1</b>					
<input type="checkbox"/> <b>Enable</b>					
<b>Destination IP</b>		<input type="text" value="231"/> - <input type="text" value="1"/> - <input type="text" value="128"/> - <input type="text" value="20"/>	[ 224.0.0.0... 239.255.255.255 ]		
<b>Port</b>		<input type="text" value="40000"/>	[1024... 65530; Only even values are available]		
<b>TTL</b>		<input type="text" value="1"/>	[1... 255]		
<b>Multicast - Stream 2</b>					
<input type="checkbox"/> <b>Enable</b>					
<b>Destination IP</b>		<input type="text" value="231"/> - <input type="text" value="1"/> - <input type="text" value="128"/> - <input type="text" value="21"/>	[ 224.0.0.0... 239.255.255.255 ]		
<b>Port</b>		<input type="text" value="40000"/>	[1024... 65530; Only even values are available]		
<b>TTL</b>		<input type="text" value="1"/>	[1... 255]		
<b>Multicast - Stream 3</b>					

## Full Menu Setup

### • **UPnP**

UPnP is enabled by default so that the network camera can be automatically detected by operating systems and clients that support this protocol.

> FRIENDLY NAME : Enter the name up to 32 alphanumeric characters like Model Name-MAC address.

#### [ NOTE ]

UPnP must also be enabled on your Windows computer. To do this, open the Control Panel from the Start Menu and select Add/Rename programs. Select Add / Remove Windows Components and open the Networking Services section. Click Details and then select UPnP as the service to add.

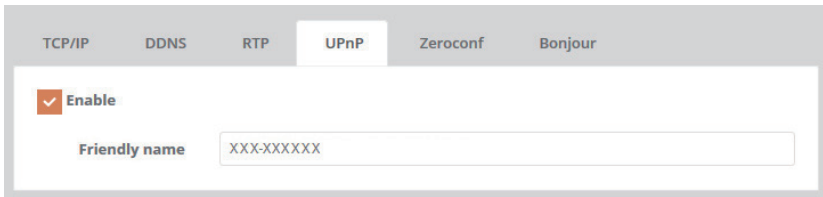

TCP/IP DDNS RTP **UPnP** Zeroconf Bonjour

Enable

Friendly name

### • **Zeroconf**

ZeroConf (Zero configuration) networking enables the network to establish automatically with the automatic assignment of numeric network addresses (zeroconf IP addresses) without requiring manual operator intervention or special configuration servers when the DHCP server is not available in the network.

> Mark ENABLE to use ZeroConf networking.

> ZeroConf ADDRESS : 169.254.xxx.xxx as default.

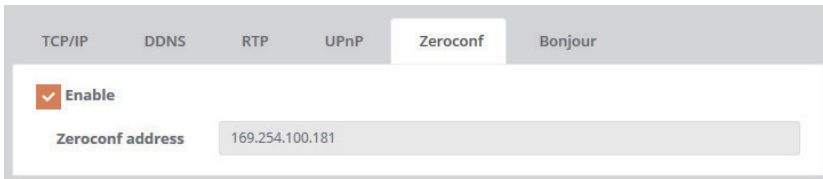

TCP/IP DDNS RTP UPnP **Zeroconf** Bonjour

Enable

Zeroconf address

### • **Bonjour**

Bonjour is Apple's implementation of zero-configuration networking (zeroconf), a group of technologies that includes service discovery, address assignment, and hostname resolution.

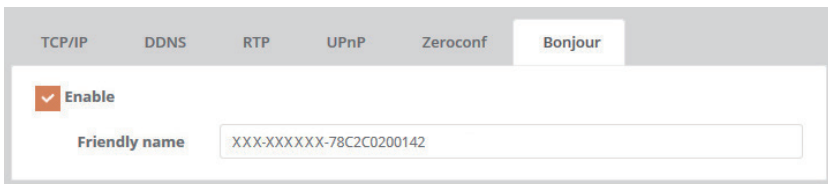

TCP/IP DDNS RTP UPnP Zeroconf **Bonjour**

Enable

Friendly name

## Full Menu Setup

### 2-4-4. Language

Six languages are available to select from English, Deutsch (German), Français (French), Polski (Polish), Suomi (Finnish), and 한국어 (Korean).

### 2-4-5. Maintenance

#### Maintenance

SETUP / System / Maintenance

⌂ ^ ×

#### Maintain

Restart
Restart the unit.

Reset
Resets all parameters to the original factory settings, except the IP address and PTZ configurations.

Default
Resets all parameters to the original factory settings.

⌂ ^ ×

#### Upgrade

Upgrade the unit with the new firmware.

Drop file here or click to upload
Upgrade

⌂ ^ ×

#### Setup Export

Save all parameters and user-defined script to a export file.

Export

⌂ ^ ×

#### Setup Import

Import configurations from exported file.

Drop file here or click to upload
Import

#### ● **Maintain**

- > RESTART : Restarts the camera without changing any settings.
- > RESET : Restarts and loads the factory settings but does not change IP address and PTZ settings.
- > DEFAULT : Loads and saves the factory defaults for all parameters including IP address and PTZ settings.

#### [ CAUTION ]

Do not disconnect the power or network cable during RESET or DEFAULT operations.

## Full Menu Setup

### • Upgrade

Bring the firmware file to the drop box or click the drop box to browse for the firmware file, and then click the UPGRADE button.

[ CAUTION ] Do not disconnect the power or network cable during firmware UPGRADE.

### • Setup Export

Current configurations for the camera can be saved as a file by clicking the EXPORT button.

### • Setup Import

The exported configuration file from a reference camera or a backup configuration can be imported and configured/reloaded onto other cameras.

#### [ NOTE ]

- SETUP EXPORT/SETUP IMPORT can only be used on the same camera models with the same firmware. This feature is not intended for the configuration of multiple units or for firmware upgrades.
- When the encrypted System configuration file with the password is imported, type the password at SETUP>SYSTEM>SECURITY>EXPORT/IMPORT with the SAME password which was used in exporting the system configuration file from the reference camera. Otherwise, 'INVALID FILE' error appears.

## 2-4-6. Logs & Report

### • Logs

The log file records the story into the unit since the system restarts.

- > DATABASE CAPACITY: Shows the useable system memory space for Log file.
- > SEARCH CONDITION: Allows you to search the log as per the type. E.g. System, Access, Event and Media, Start-End date and Start-End time.
- > LOG LIST: Shows the logs as per the search.

### • Report

Provides overall information about the server status.

## 3. USER MANUAL

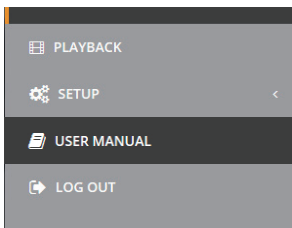

Help the menu function.

Click and pop-up the page about current menu description.

## Troubleshooting

If you suspect a problem is being caused by incorrect configuration or some other minor problem, consult the troubleshooting guide below.

### Upgrading the Firmware

Firmware is software that determines the functionality of the network camera. One of your first actions when troubleshooting a problem should be to check the current firmware. The latest version may contain a correction that fixes your particular problem. The current firmware version in your camera is displayed on the Basic Configuration or About. For the latest firmware of the camera, please contact with your product administrator.

Detailed instructions on how to perform the upgrade process are provided with each new release.

### General Troubleshooting

The following list covers some of the problems that may be encountered and suggests how to remedy them:

Symptom	Guide
The camera cannot be accessed by some clients.	If using a proxy server, try disabling the proxy setting in your browser. Check all cabling and connectors.
The camera works locally, but not externally	Check if there are firewall settings that need to be adjusted. Check if there are router settings that need to be configured.
Poor or intermittent network connection.	If using a network switch, check that the port on that device uses the same setting for the network connection type (speed/duplex).
The camera cannot be accessed via a host name.	Check that the host name and DNS server settings are correct.
Not possible to log in.	When HTTPS is enabled, ensure that the correct protocol (HTTP or HTTPS) is used. When attempting to log in, you may need to manually type in http or https in the browser's address bar.
No image using Refresh and/or slow updating of images.	If images are very complex, try limiting the number of clients accessing the camera.
Images only shown in black & white.	Check the Video & Image setting.
Blurred images.	Refocus the camera.

## Troubleshooting

Poor image quality.	Increased lighting can often improve image quality. Check that there is sufficient lighting at the monitored location. Check all image and lighting settings.
Rolling dark bands or flickering in image.	Try adjusting the Exposure Control setting under AE and AWB part.
H.264 not displayed in the client.	Check that the correct network interface is selected in the Video & Image/Stream.
Multicast H.264 not displayed in the client.	Check with your network administrator that the multicast addresses used by the camera are valid for your network. Check that the Enable multicast checkbox are enabled in the System/Network/RTP tab. Checks with your network administrator to see if there is a firewall preventing viewing.
Multicast H.264 only accessible by local clients.	Check if your router supports multicasting, or if the router settings between the client and the server need to be configured. The TTL value may need to be increased.
Color saturation is different in H.264 and Motion JPEG.	Modify the settings for your graphics adapter. Please see the adapter's documentation for more information.

### **[ NOTE ]**

If you cannot find the help you require, please see the User's Manual, or contact with your network administrator.



eneo® is a registered trademark of  
VIDEOR E. Hartig GmbH  
Exclusive distribution through specialised  
trade channels only.

VIDEOR E. Hartig GmbH  
Carl-Zeiss-Straße 8  
63322 Rödermark/Germany  
Tel. +49 (0) 6074 / 888-0  
Fax +49 (0) 6074 / 888-100  
[www.videor.com](http://www.videor.com)  
[www.eneo-security.com](http://www.eneo-security.com)

Technical changes reserved

© Copyright by VIDEOR E. Hartig GmbH  
Version 04/2018