

# User Manual

**Netzwerk Video Rekorder, H.264,  
ohne HDD, HDMI, PoE**

**IER-25R040004A**



**IER-25N080004A**

**IER-25N160004A**

# WARNING

TO REDUCE THE RISK OF FIRE OR ELECTRIC SHOCK, DO NOT EXPOSE THIS PRODUCT TO RAIN OR MOISTURE. DO NOT INSERT ANY METALLIC OBJECT THROUGH THE VENTILATION GRILLS OR OTHER OPENINGS ON THE EQUIPMENT.

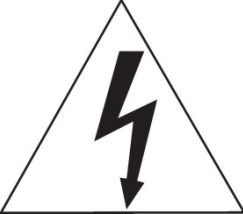
# CAUTION

	<b>CAUTION</b> RISK OF ELECTRIC SHOCK DO NOT OPEN	
<p>WARNING: TO REDUCE THE RISK OF ELECTRIC SHOCK, DO NOT REMOVE COVER (OR BACK). NO USER-SERVICABLE PARTS INSIDE. REFER SERVICING TO QUALIFIED SERVICE PERSONNEL</p>		

## EXPLANATION OF GRAPHICAL SYMBOLS



The lightning flash with arrowhead symbol, within an equilateral triangle, is intended to alert the user to the presence of dangerous voltage within the products enclosure that may be of sufficient magnitude to constitute a risk of electric shock to persons.



The exclamation point within an equilateral triangle is intended to alert the user to the presence of important operating and maintenance (servicing) instructions in the literature accompanying the product.



# FCC COMPLIANCE STATEMENT

This device complies with Part 15 of the FCC Rules. Operation is subject to the following two conditions: (1) this device may not cause harmful interference, and (2) this device must accept any interference received, including interference that may cause undesired operation.

**FCC INFORMATION:** This equipment has been tested and found to comply with the limits for a Class A digital device, pursuant to Part 15 of the FCC Rules. These limits are designed to provide reasonable protection against harmful interference when the equipment is operated in a commercial environment. This equipment generates, uses, and can radiate radiofrequency energy and, if not installed and used in accordance with the instruction manual, may cause harmful interference to radio communications. Operation of this equipment in a residential area is likely to cause harmful interference in which case the user will be required to correct the interference at his own expense.

**CAUTION:** Changes or modifications not expressly approved by the party responsible for compliance could void the user's authority to operate the equipment.

This Class A digital apparatus complies with Canadian ICES-003.  
Cet appareil numérique de la classe A est conforme à la norme NMB-003 du Canada.

# CE COMPLIANCE STATEMENT

## **WARNING**

This is a Class A product. In a domestic environment this product may cause radio interference in which case the user may be required to take adequate measures.

## **CAUTION**

RISK OF EXPLOSION IF BATTERY IS REPLACED BY AN INCORRECT TYPE.  
DISPOSE OF USED BATTERIES ACCORDING TO THE INSTRUCTIONS.

# IMPORTANT SAFETY INSTRUCTIONS

---

1. Read these instructions.
2. Keep these instructions.
3. Heed all warnings.
4. Follow all instructions.
5. Do not use this apparatus near water.
6. Clean only with dry cloth.
7. Do not block any ventilation openings. Install in accordance with the manufacturer's instructions.
8. Do not install near any heat sources such as radiators, heat registers, stoves, or other apparatus (including amplifiers) that produce heat.
9. Do not defeat the safety purpose of the polarized or grounding-type plug. A polarized plug has two blades with one wider than the other. A grounding type plug has two blades and a third grounding prong. The wide blade or the third prong is provided for your safety. If the provided plug does not fit into your outlet, consult an electrician for replacement of the obsolete outlet.
10. Protect the power cord from being walked on or pinched particularly at plugs, convenience receptacles, and the point where they exit from the apparatus.
11. Only use attachments/accessories specified by the manufacturer.
12. Use only with the cart, stand, tripod, bracket, or table specified by the manufacturer, or sold with the apparatus. When a cart is used, use caution when moving the cart/apparatus combination to avoid injury from tip-over.
13. Unplug this apparatus during lightning storms or when unused for long periods of time.
14. Refer all servicing to qualified service personnel. Servicing is required when the apparatus has been damaged in any way, such as power-supply cord or plug is damaged, liquid has been spilled or objects have fallen into the apparatus, the apparatus has been exposed to rain or moisture, does not operate normally, or has been dropped.
15. **CAUTION – THESE SERVICING INSTRUCTIONS ARE FOR USE BY QUALIFIED SERVICE PERSONNEL ONLY. TO REDUCE THE RISK OF ELECTRIC SHOCK DO NOT PERFORM ANY SERVICING OTHER THAN THAT CONTAINED IN THE OPERATING INSTRUCTIONS UNLESS YOU ARE QUALIFIED TO DO SO.**
16. **Use satisfy clause 2.5 of IEC60950-1/UL60950-1 or Certified/Listed Class 2 power source only.**
17. ITE is to be connected only to PoE networks without routing to the outside plant.



# Table of Contents

Table of Contents.....	1
<b>1. Overview</b>	<b>3</b>
1.1 Package Contents .....	4
1.2 NVR Description .....	4
<b>2. Installation</b>	<b>6</b>
2.1 Installing HDD .....	7
2.2 Starting System .....	7
2.3 Quick Setup.....	8
2.3.1 Account.....	8
2.3.2 System.....	8
2.3.3 Network.....	9
2.3.4 Time/Date.....	9
2.3.5 Easy Installation Wizard.....	10
<b>3. Live Screen Configuration</b>	<b>11</b>
3.1 Icons in Live screen.....	12
3.2 Live Launcher menu .....	13
3.2.1 Backup.....	14
3.3 Quick menu .....	15
3.3.1 PTZ Control .....	16
3.3.2 Camera Registration.....	17
3.3.3 Status > System log.....	19
3.3.4 Status > Event.....	20
3.3.5 Status > Record.....	21
3.3.6 Status > Disk.....	22
<b>4. Setup menu</b>	<b>23</b>
4.1 General buttons in Setup menu .....	25
4.2 SYSTEM .....	26
4.2.1 System.....	26
4.2.2 Time/Date.....	28
4.2.3 Account > User.....	31
4.2.4 Configuration (Config) .....	33
4.3 CAMERA.....	35

4.3.1	Basic.....	35
4.3.2	Advanced .....	38
4.4	DEVICE .....	39
4.4.1	Display.....	39
4.4.2	Disk > Setup .....	43
4.4.3	PTZ > PTZ .....	46
4.4.4	Serial Device > Serial Device.....	47
4.4.5	Text > Text.....	48
4.5	RECORD.....	50
4.5.1	Schedule > Schedule.....	50
4.5.2	Stream.....	53
4.6	EVENT .....	57
4.6.1	System/Disk .....	57
4.6.2	Alarm In.....	59
4.6.3	Motion .....	62
4.6.4	Video Loss > Setup.....	64
4.6.5	Notification.....	65
4.7	NETWORK.....	67
4.7.1	Basic.....	67
4.7.2	DVRNS/DDNS .....	69
4.7.3	E-Mail .....	71
4.7.4	FTP.....	72
4.7.5	Warp .....	73
4.7.6	P2P.....	74
4.7.7	Notification Server.....	75
<b>5.</b>	<b>Search/Play</b>	<b>77</b>
5.1	Search .....	77
5.2	Playback.....	82
5.2.1	Record Time-Line.....	82
5.2.2	Playback Quick menu .....	83
<b>6.</b>	<b>Webviewer</b>	<b>84</b>
<b>7.</b>	<b>Appendix</b>	<b>87</b>
7.1	Installing System Keyboard .....	87
7.2	Products Specification.....	92

# 1. Overview

This chapter describes NVR overview, components and their terms and features.

This manual introduces a network video recorder (NVR) which monitors or record, controls images via a network camera.

Multiple users may monitor video at the same time, and many cameras can be controlled simultaneously by a manager. Also, through a PC or a smartphone, video might be monitored by transmitting video and audio using a network.

The device features include the following:

- Convenient UI from user's viewpoint
- IP camera input 4/8/16 channels
- Providing H.264 compression
- Up to 5MP real time recording
- HDD information and status presentation
- HDD overwriting.
- High capacity back-up with USB 3.0
- Simultaneous recoding and playing of 4/8/16 channels
- Various search mode (time, event, thumbnail and Text)
- Various recording mode (manual, event, timed recording, panic recording)
- Remote monitoring through a network viewer, a web viewer, and a mobile viewer

## 1.1 Package Contents

The device package contents consist of the following:

 **Note** Please check all components involved.

**Table 1-1 Package contents**

No	Name	번호	Name
1	NVR	6	SATA cable
2	DC adapter & Power cord	7	SATA power cable
3	Mouse	8	HDD fixing screw
4	Quick guide	9	Program CD

## 1.2 NVR Description

Each part is listed in the below:

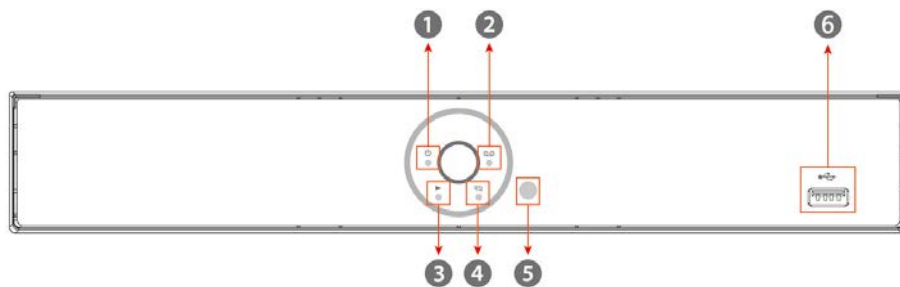

**Figure 1-1 Name and Connection of each front section**

**Table 1-2 Name and Function of each front section**

No.	Name	Function
1	PWR	Pointing out device ON/OFF.
2	REC	Pointing out recording in process.
3	PB	Pointing out playback in process.
4	NET	With a network viewer, pointing out network in connection.
5	IR Remote Control Sensor	Receives all incoming signals from the remote control.
6	USB port	USB port is connected for USB mouse or firmware upgrade, and data back-up.



### 4ch NVR

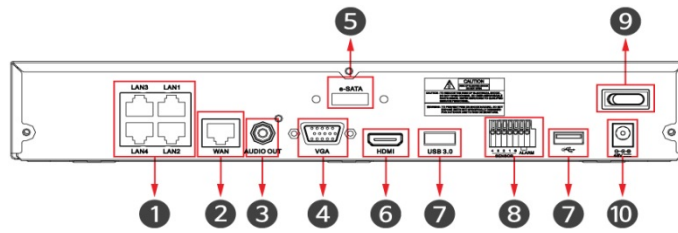

### 8ch NVR

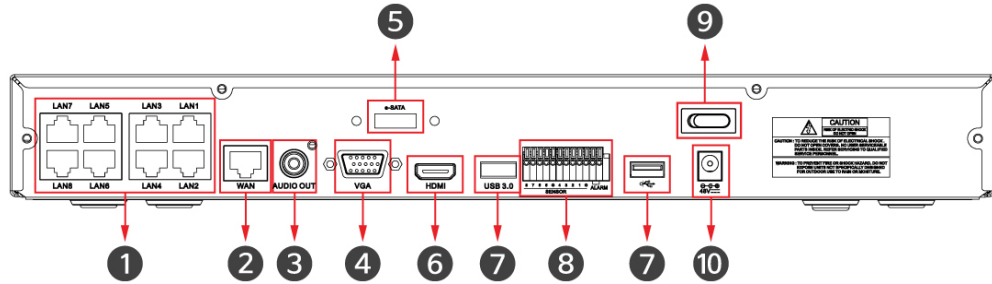

### 16ch NVR

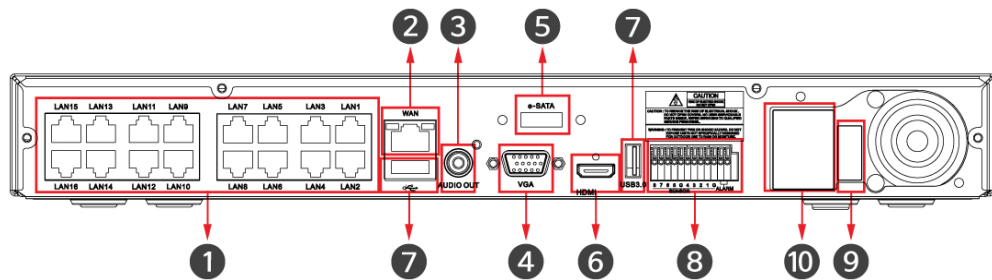

Figure 1-2 Name and Connection of rear section of 4ch, 8ch and 16ch NVR

Table 1-3 Name and Function of rear section of 4ch, 8ch and 16ch NVR

No.	Name	Function
1	IP CAM / PoE	IP camera input port, IEEE802.3af PoE support
2	Network	Network connector
3	Audio Out	Audio output port
4	VGA	VGA output port
5	e-SATA	e-SATA storage connection connector
6	HDMI	HDMI output port
7	USB	USB port is connected for data back-up
8	Alarm In/Out	Alarm connector
9	Power Switch	On/Off the Power
10	Power Input	Connect power supply

## 2. Installation

This chapter describes the way to install NVR.

When installing a device, connect rear of the device with each port on the basis of below connection map.

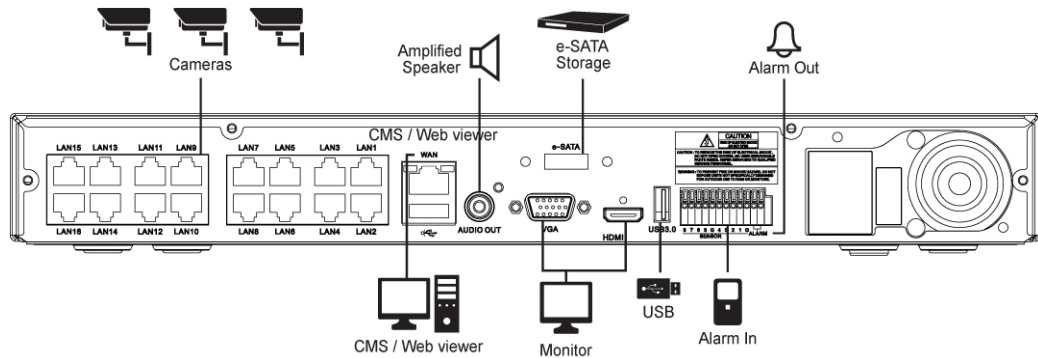

**Figure 2-1 Connection map**

The device starts first like below sequences:

- 1 Installing HDD
- 2 Connecting with an exterior device
- 3 Starting a system
- 4 Setting an quick setup

## 2.1 Installing HDD

How to install HDD in the device:



- Withdraw the mains plug before installing HDD to reduce the risk of injury or electrical shock, or device malfunction.
- Make sure to check the compatibility of HDD with the device.

- 1 Always switch off and unplug the unit.
- 2 Unscrew with a screw driver (+) and open the unit cover.
- 3 Install HDD in the bottom case.
- 4 Connect a data cable and power cable with HDD.
- 5 Close the cover and tighten screws.

## 2.2 Starting System

Power supply begins with system operation as follows:

- 1 Switching on initialize with below icons in order.



**Note** Installing new HDD might take more initialize time.

- 2 With buzzer sounds, the start screen is presented.
- 3 In **Log in** screen, enter the **ID, Password** and press **OK**.

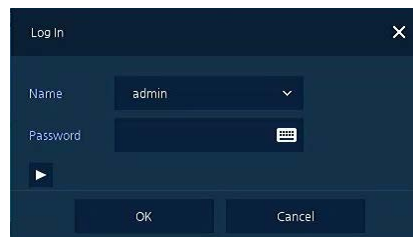

**Note** Default **ID & Password** is admin/admin



Please change password after login due to security.

Click  to see the MAC address.

**Note** If lost password, inform the MAC address to supplier to create temporary password.

## 2.3 Quick Setup

### 2.3.1 Account

- 1 Click the keyboard icon to set **ID** and **Password** users want.

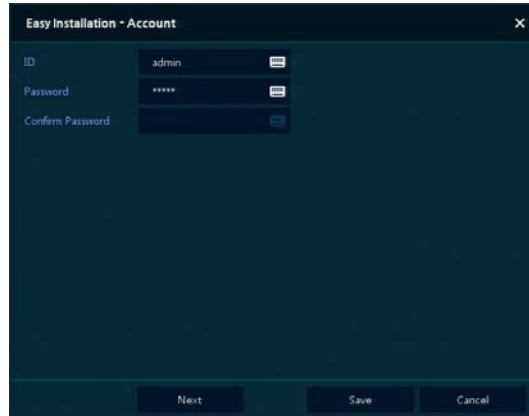

---

**Note**

- Default ID/Password is admin/admin.
  - Change the password for security.
  - Max character length is 16.
- 

### 2.3.2 System

- 1 Set each item in **System** setting screen.

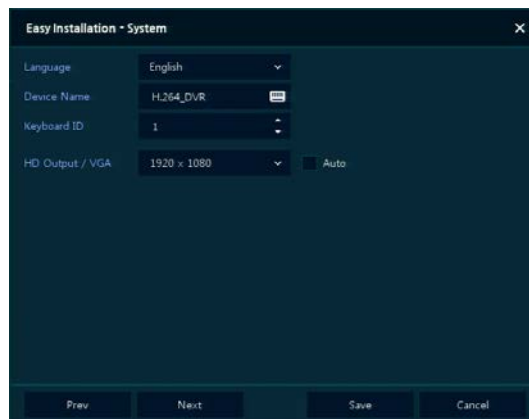

- Language: Select system language.
- Device Name: Enter the device name.
- Keyboard ID: To identify device usages in controlling NVR with RS485 through a keyboard
- Selecting the device ID. In case of simultaneous use of equipment, set ID with difference.

---

**Note**

- As for using many NVRs, set ID with difference.
- 

- HDMI/VGA: Set resolution of a monitor connected to the device.

- 2 Press **Save** button to save set value.

- 3 Press **Next** to end System setting and move the next setting phase.

### 2.3.3 Network

How to set the network of Easy Installation:

- 1 Set each item in **Network** setting screen.

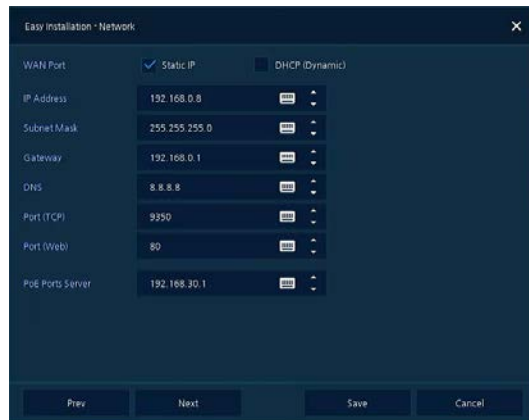

- WAN Port: Select whether to use static IP or dynamic IP.
- IP Address, Subnet Mask, Gateway, DNS, and Port: As for dynamic IP, enter information in each space.

- 2 Press **Save** button to save set value.

- 3 Press **Next** to end Network setting and move the next setting phase.

### 2.3.4 Time/Date

How to set the time/date of Easy Installation:

- 1 Set each item in **Time/Date** setting screen.

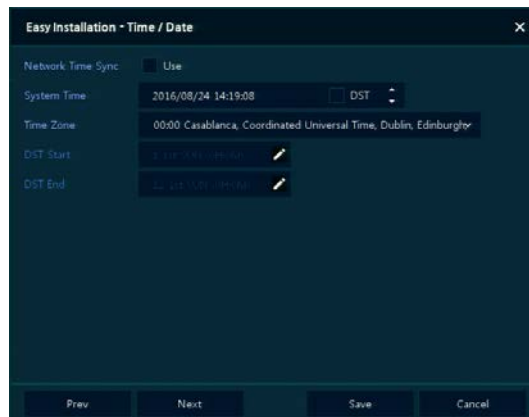

- Network Time Sync: Select network for synchronizing with time server.
- System Time: Not for synchronizing with network time server, set the device time; otherwise (applying for Daylight saving time), select DST.
- Time Zone: Select time zone for the system being installed.
- DST Start/End: For applying Daylight saving time, set the application period.

- 2 Press **Save** button to save set value.

- 3 Press **Next** to end Time/Date setting and move the next setting phase.

## 2.3.5 Easy Installation Wizard

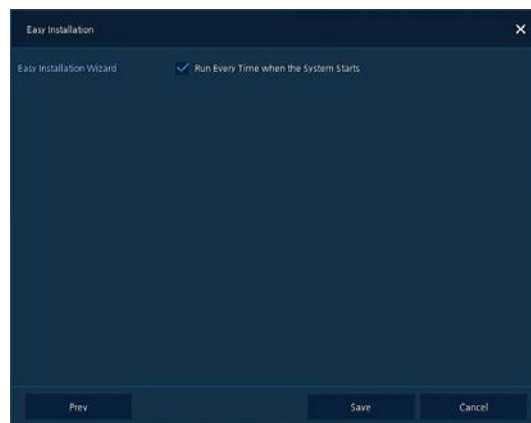

- 1 Select to run Easy Installation every time when the system start.
- 2 Press **Save** button to save set value and end Easy Installation.

### 3. Live Screen Configuration

UI screen is configured like below figure.

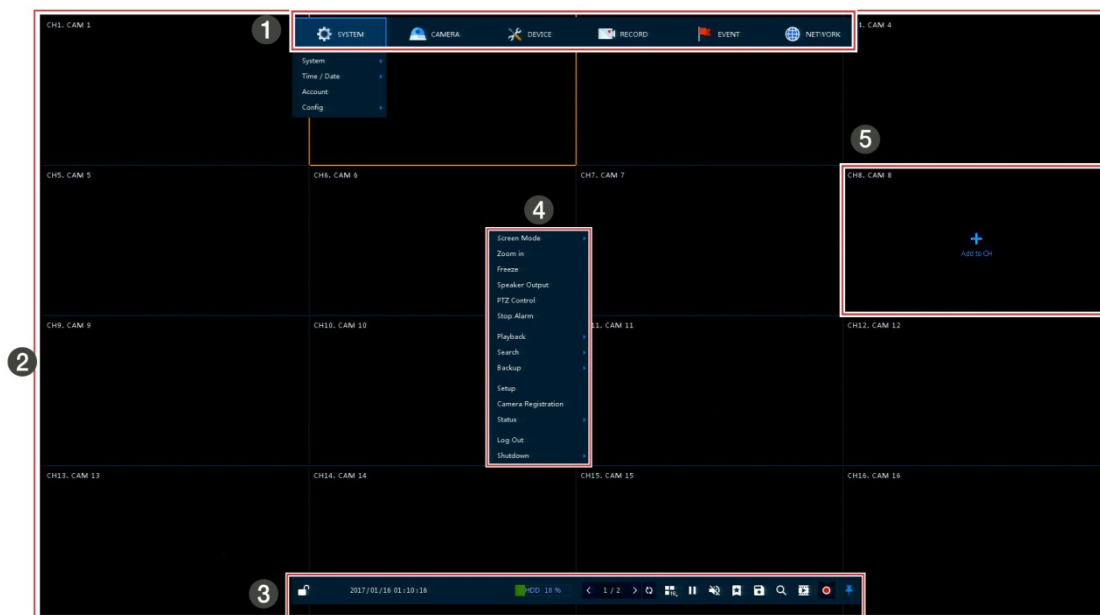

Figure 3-1 UI Screen Configuration

Table 3-1 Items and Description of UI Screen Configuration

No.	Item	Description
1	Setup menu	Setting menu is located in the corner of upper screen. See “4 Setup” to display detailed information about the setting menu.
2	Live screen	Show live video of connected cameras.
3	Launcher menu	Launcher menu is located in the corner of below screen. See “3.2 Live Launcher” to display detailed information about the launcher menu.
4	Quick menu	Clicking the right button of a mouse displays Quick menu. See “3.3 Quick menu” to display detailed information about the quick menu.
5	Add to CH	Move mouse cursor on the center of window to register IP camera manually. See “3.3.2 Camera Registration” to display detailed information about the camera registration.

### 3.1 Icons in Live screen

Each icon in the live screen displays a present setting status or a function. UI screen consists of like below.

**Note** Chosen live screen is marked as a blue frame; mouse-located live screen is marked as yellow one.

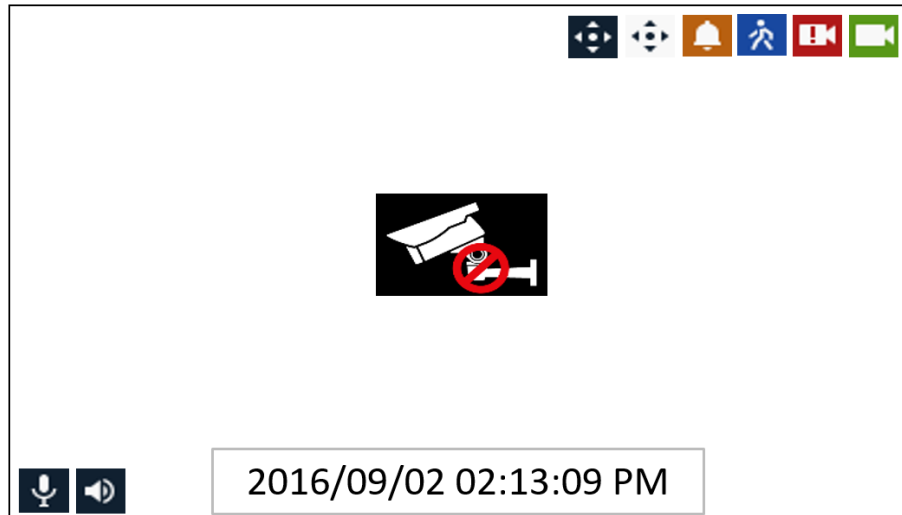

Figure 3-2 Live screen icon

Table 3-2 Live screen icon and its description

No.	Icon	Description
1	CH1 CAM1	Channel numbers and camera titles.
2		A camera with PTZ function.
		PTZ control function in process.
		Recording in alarm event mode.
		Recording in motion event mode.
		Recording in panic recording mode.
		Recording in consecutive recording mode.
3		Video loss icon.
4		Mic on/off.
		Speaker on/off.
6		Displaying present time and date.















## 3.2 Live Launcher menu

This chapter describes Launcher menu in the bottom of the screen.



Figure 3-3 Launcher menu

Table 3-3 Launcher menu Item and Description

No.	Item	Description
1		Log in/out status and logged in ID.
2	Date & Time	Displaying present date and time.
3	HDD	Displaying HDD capacity in use.
4		Moving to previous/next partition screen.
5		Displaying live screen in order set (toggle).
6		Selecting partition mode to mark in live screen (single screen, 4-, 9-, and 16-partition).
7		Stopping or replaying selected live screen images (toggle).
8		Audio on or mute chosen live screen (toggle).
9		Instant recording for 10 seconds.
10		Make a backup video of users want. See "3.2.1 Backup " to display detailed information about back-up.
11		Searching recording data (time, event, thumbnail, smart search, text and VCA). See "5.1 Search" to display detailed information about search.
12		Playback recorded data.
13		Starting immediate recording of selected channel.
14		Locking or releasing launcher menu (toggle).

### 3.2.1 Backup

The device provides a back-up function of live screen.

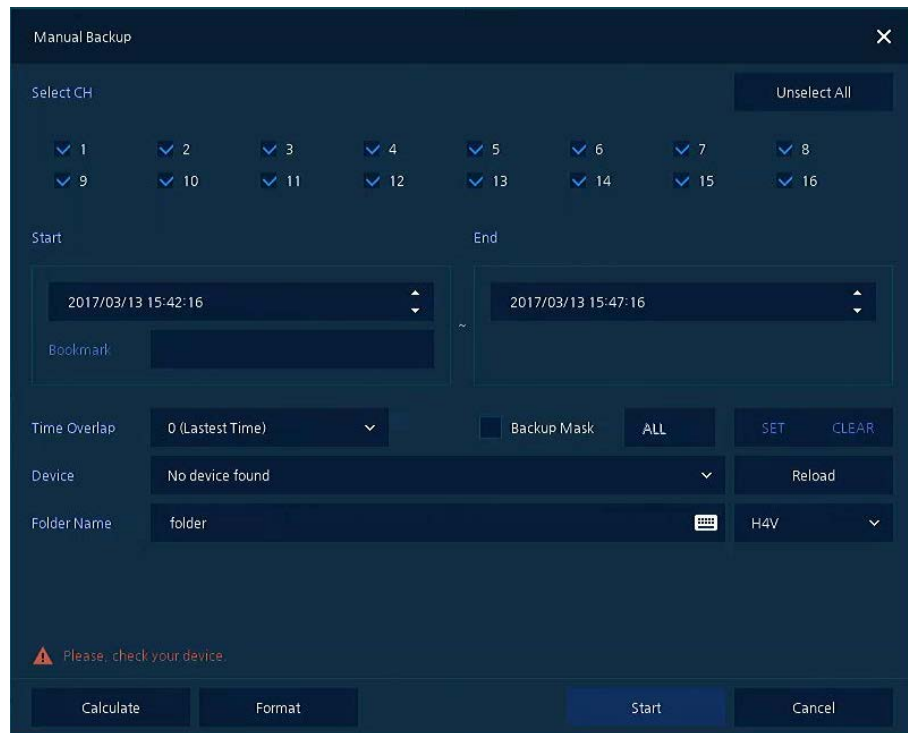

**Figure 3-4 Backup**

**Table 3-4 Backup Item and Description**

No.	Item	Description
1	Select CH	Selecting a channel users want to back-up.
2	Select All/ Unselect All	Select or clear all channels.
3	Start	Setting back-up start time (Bookmark: bookmark list).
4	End	Setting back-up ending time (Bookmark: bookmark list).
5	Time Overlap	Selecting time if there are two recorded data in the same time.
6	Backup Mask	User can mask selected area. It works H4V format only.
7	Device	Selecting the device to save back-up files.
8	Reload	Opening the device information.
9	Folder Name	Entering a folder name to save back-up files.
10	File format	Selecting a file format to back-up.
11	Calculate	Calculating data capacity to back-up.
12	Format	Formatting the device to back-up.
13	Start	Starting back-up.
14	Cancel	Closing the backup screen.

### 3.3 Quick menu

This chapter depicts Quick menu when users click the right button of the mouse in live screen.

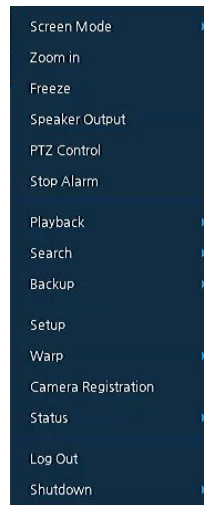

**Figure 3-5 Quick menu**

**Table 3-5 Quick menu Item and Description**

No.	Item	Description
1	Screen Mode	Selecting the partition mode of live screen (Full, 2X2, 3X3, and 4x4).
2	Zoom in	Magnifying selected live screen (Zoom out, 2 times, 4 times, and 8 times). This menu is shown full screen mode only.
3	Freeze	Freezes the video selected live screen images (toggle on/off).
4	Speaker Output/Mute	Turning on/off a sound speaker.
5	PTZ Control	Controlling PTZ function. This menu is shown when PTZ camera connected.
6	Stop Alarm	Stopping monitoring alarm output and event.
7	Text Overlay	POS text overlay on the screen. This menu is show when enable Text menu.
8	Playback	Playing selected live screen images (before 30 sec, 1 min, 5 min, 10 min, 30 min, 1-hour, Go to last play time, and Go to last record time).
9	Search	Searching recording data (time, event, thumbnail, smart search, text and VCA). See "5.1 Search" to display detailed information about search.
10	Backup	Backup video to USB drive. See "0 " to display detailed information about back-up.
11	Setup	Opens the NVRs main setup menu. For more information about setting menu, see section "4 Setup".
12	Warp	Monitor and control for remote recorder.
13	Camera Registration	Opens a pop-up menu for IP camera registration.
14	Status	Opens a pop-up menu showing device system log, event, and recording status (system log, event, and record).

No.	Item	Description
15	Log in/Log out	Log in/Log out.
16	Shutdown	Shuts down or restarts the device (shutdown, restart).

### 3.3.1 PTZ Control

The location of images may be moved to monitor with PTZ ball.

**Note** PTZ Control menu can be displayed if relevant channel's protocol is set in **DEVICE > PTZ** in the upper live screen.

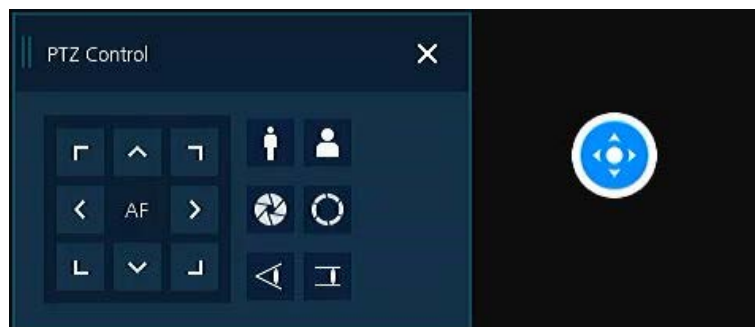









Figure 3-6 Quick menu > PTZ Control

Table 3-6 Quick menu > PTZ Control Item and Description

No.	Item	Description
1		Moving images with direction buttons.
2		Moving images with PTZ ball.
3	AF	Adjusting screen focus automatically.
4	 Zoom Out	Zoom function of PTZ camera.
5	 Zoom In	
6	 Iris Close	Adjust Iris manually.
7	 Iris Open	
8	 Focus Far	Adjust focus manually.
9	 Focus Near	

In PTZ Control screen, clicking the right button of the mouse displays Quick menu.

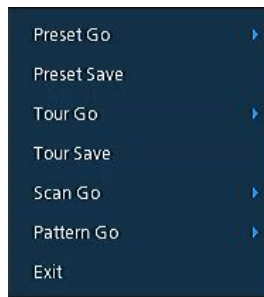

Figure 3-7 PTZ Control Quick menu

Table 3-7 PTZ Control Item and Description in Quick menu

No.	Item	Description
1	Preset Go	Run selected Preset number.
2	Preset Save	Save specific positions of the camera, at most 255 settings.
3	Tour Go	Run Tour function.
4	Tour Save	Save multiple preset positions to run each position in order.
5	Scan Go	Run Scan function.
6	Pattern Go	Run Pattern function.
7	Exit	Exit to live screen menu in PTZ Control menu.

### 3.3.2 Camera Registration

Users can register the IP cameras.

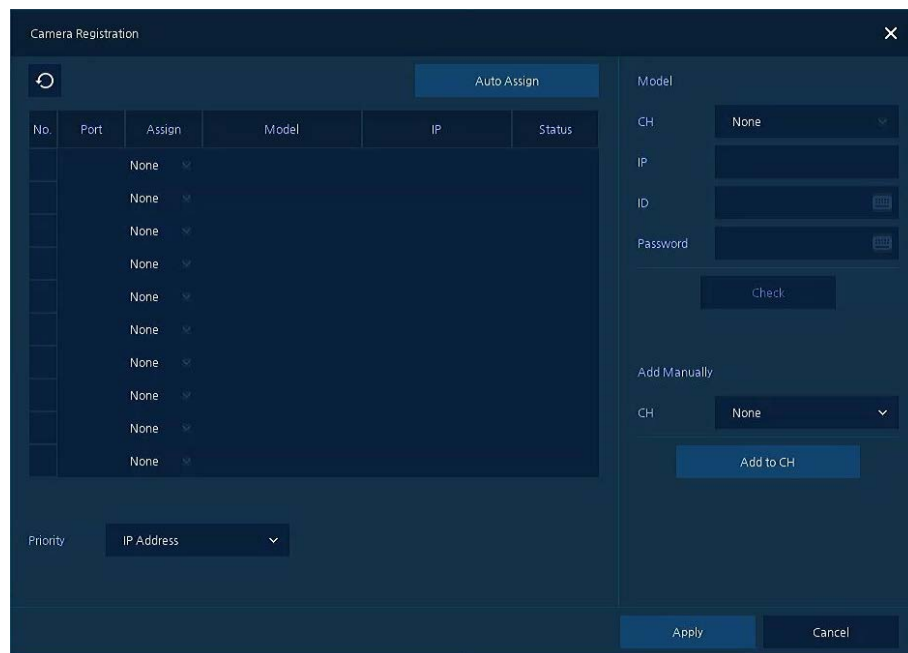

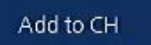



Figure 3-8 Quick Menu > Camera Registration

**Table 3-8 Quick Menu > Camera Registration Item and Description**

No.	Item	Description
1		Search the connected IP cameras.
2	Auto Assign	Automatically assign the channel windows.
3	Port	Show the detected camera port (WAN, PoE).
4	Assign	Selecting the channel windows manually.
5	Model	Show detected camera model number.
6	IP	Show detected camera IP address.
7	Status	Show connection status.
8	Priority	Select IP Address or Zero conf IP. When camera have IP address and zero conf IP, NVR display selected priority address.
9	Add Manually	Select channel and click  to open manual add window.

**Add Manually**

Click  to open Camera Registration. Or move mouse point at the middle of channel window on the live screen and click .

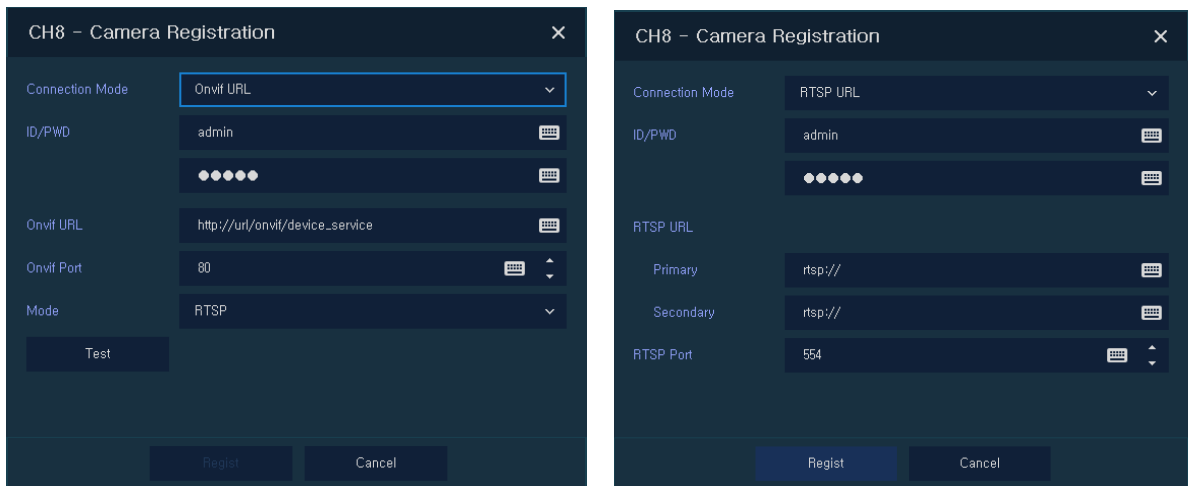

**Figure 3-9 Camera Registration (manual add)**

**Table 3-9 Camera Registration (manual add)**

No.	Item	Description
1	Connection Mode	Select connection mode as Onvif or RTSP.
2	ID/PWD	Enter ID and password of IP camera.
3	Onvif URL	Enter camera IP address.
4	RTSP URL	Enter Primary and Secondary RTSP IP address and URL.

No.	Item	Description
5	Onvif Port	Enter web port. Default port is 80.
6	RTSP Port	Enter RTSP port. Default port is 554.
7	Mode	Select video stream format (RTSP/HTTP).

### 3.3.3 Status > System log

Users can see the system log information in **System log** tap in **Status** screen.

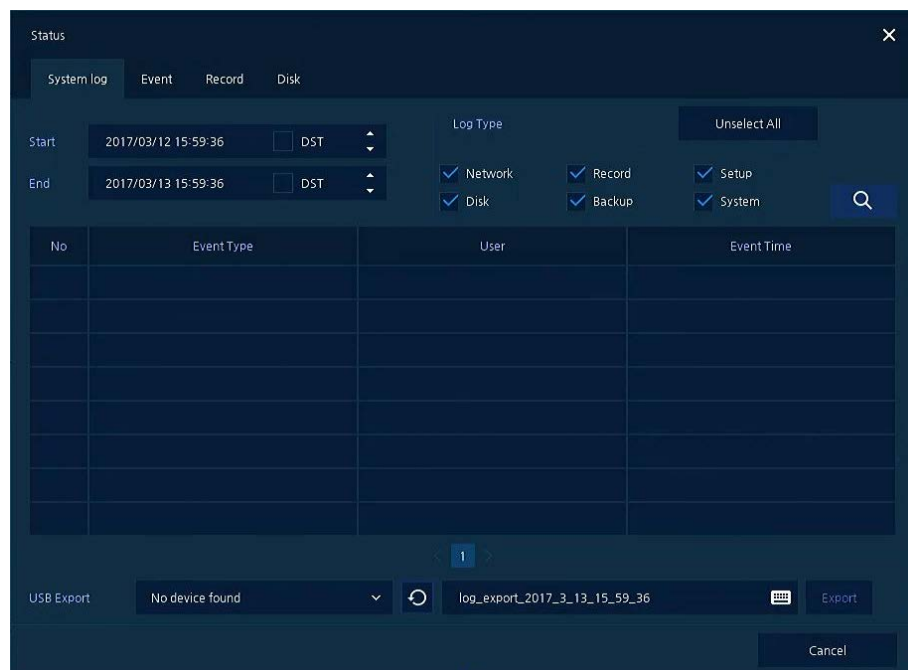



Figure 3-10 Status > System log in Quick menu

Table 3-10 Status of Quick menu > System log Item and Description

No.	Item	Description
1	Start	Setting starting time of system log to search.
2	End	Setting ending time of system log to search.
3	Log Type	Selecting log types (Network, Record, Setup, Disk, Backup, and System).
4	Select All /Unselect All	Selecting or clearing all log types (toggle).
5		Pressing search button search on the basis of set condition.
6	System log list	Displaying system log lists.
7	USB Export	Export the log data to USB thumb drive. File format is csv.
8	Cancel	Completing the status screen.

### 3.3.4 Status > Event

Users can see the real-time event information of the unit in **Event** tap in **Status** screen.

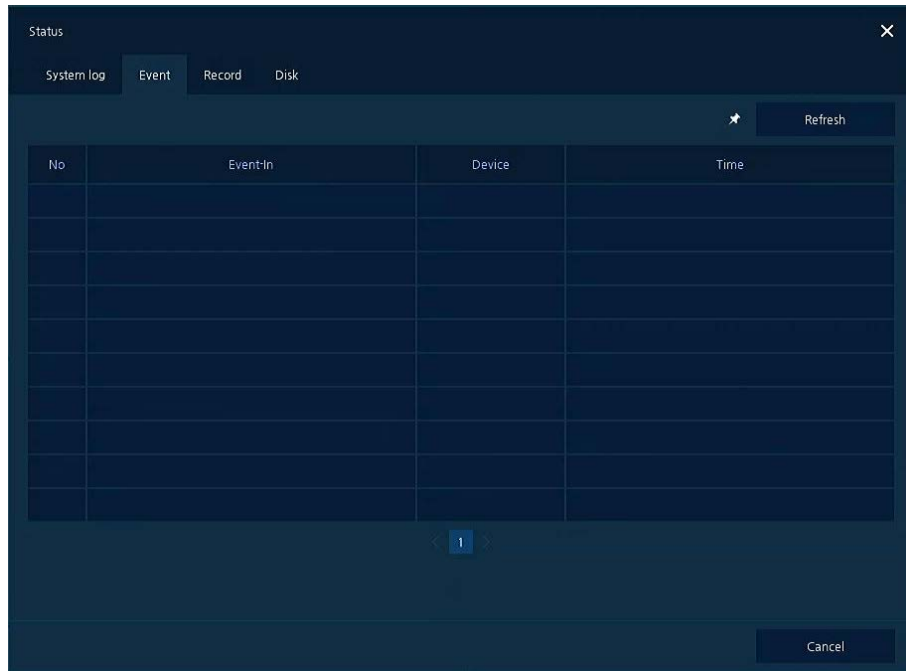

**Figure 3-11 Status > Event in Quick menu**

**Table 3-11 Status > Event Item and Description in Quick menu**

No.	Item	Description
1		Temporary fixing or releasing an event list (toggle).
2	Refresh	Deleting the event list.
3	Event list	Displaying the event list.
4	Cancel	Completing the status screen.



### 3.3.5 Status > Record

Users can see the recording status in **Record** tap in **Status** screen.

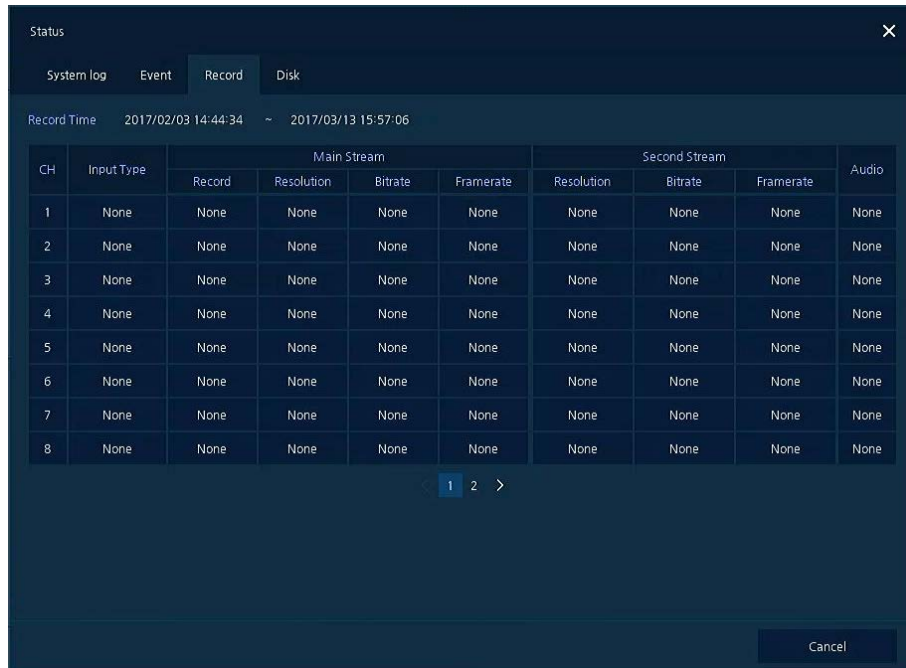

Figure 3-12 Status > Record in Quick menu

Table 3-12 Status > Record Item and Description in Quick menu

No.	Item	Description
1	Record time	Marking recorded period.
2	Record list	Displaying the record setting status.
3	Cancel	Completing the status screen.

### 3.3.6 Status > Disk

Users can see the disk status in **Disk** tap in **Status** screen.

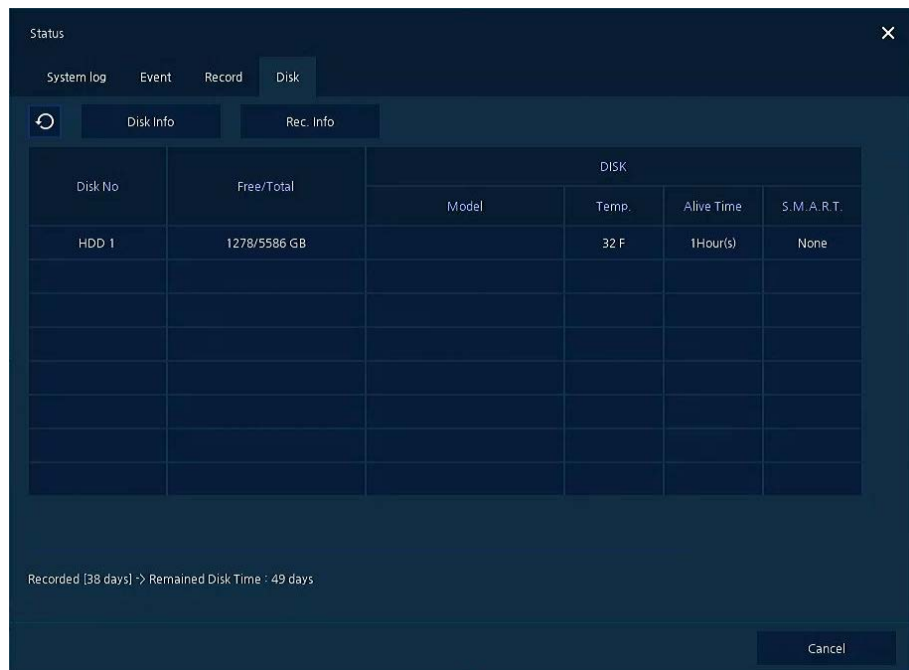

**Figure 3-13 Status > Disk in Quick menu**

**Table 3-13 Status > Disk Item and Description in Quick menu**

No.	Item	Description
1	Disk Info	Display disk temperature and S.M.A.R.T information.
2	Rec. Info	Display recording period.
3	Cancel	Completing the status screen.

## 4. Setup menu

This chapter describes Setup menu in the upper side of the screen.



Figure 4-1 Setup menu

Selecting the menu opens the setting screen.

---

**Note** Setup screen is available to click **Setup in** Quick menu by clicking the right button of the mouse.

---

Table 4-1 Setup menu Item and Description

No.	Item	Description
1	SYSTEM	Setting the system environment.
2	CAMERA	Setting the camera.
3	DEVICE	Setting the non-camera devices connected to the NVR.
4	RECORD	Setting the recording parameters.
5	EVENT	Setting each event.
6	NETWORK	Setting the network environment.

Setup menu includes:

**Table 4-2 Setup menu tree**

1 Depth	2 Depth	3 Depth
SYSTEM	System	System
		F/W Upgrade
	Time/Date	Time/Date
		Holiday
	Account	User
	Configuration	Export/Import
Factory Default		
CAMERA	Basic	Basic(Title, Covert)
		Audio In/Out
	Advanced	Advanced(Video, Stream, VA)
Registration	Registration	
DEVICE	Display	Display
		OSD
		Sequence
	Disk	Setup
		iSCSI
	PTZ	PTZ
Serial Device	Serial Device	
Text	Text	
RECORD	Schedule	Schedule
	Stream	Main Stream
		Sub Stream
	Panic	
EVENT	System/Disk	System
		Disk
	Alarm In	Setup
		Schedule
	Motion	Setup
		Schedule
Video Loss	Setup	
Notification	Periodic	

1 Depth	2 Depth	3 Depth
		Schedule
NETWORK	Basic	WAN Port
		PoE Port
	DVRNS/DDNS	DVRNS/Dashboard
		DDNS
	E-Mail	E-Mail
	FTP	FTP
	Warp	Registration
	P2P	P2P
	Notification Server	Notification Server
Notification Message		

## 4.1 General buttons in Setup menu

This section depicts General buttons in Setup menu.

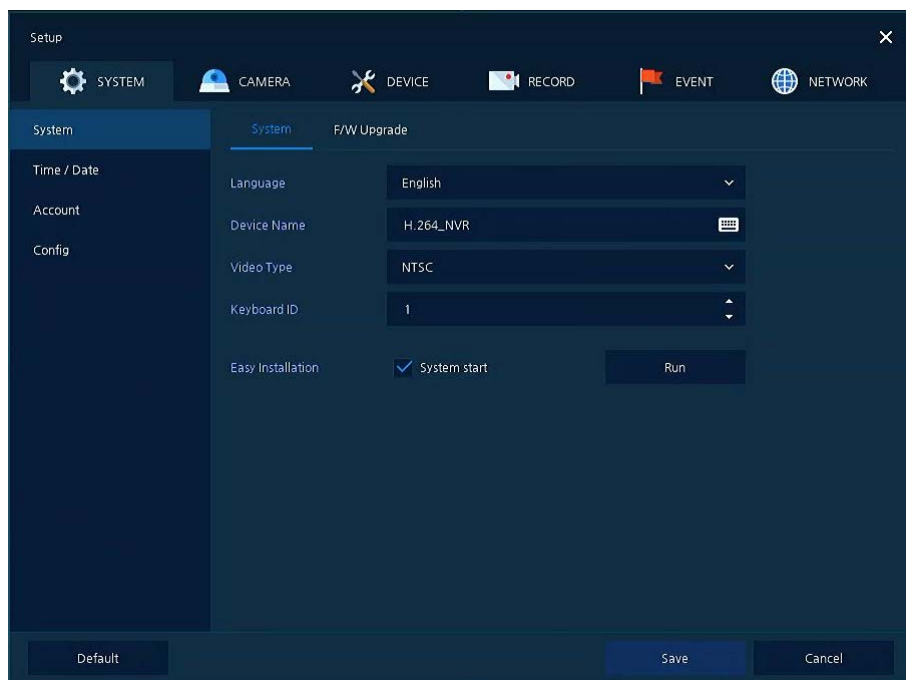

Figure 4-2 General buttons in Setup menu

Table 4-3 Item and Description of General buttons in Setup menu

No.	Item	Description
1	Default	Reverse changed setting value to default in factory.
2	Save	Save the set content.
3	Cancel	Close window.

No.	Item	Description
4	Restore	Cancel the set value, and reverse it to previous value.
5	Apply	Apply the content set.

## 4.2 SYSTEM

In **SYSTEM**, basic system environment is set.

### 4.2.1 System

Set and upgrade the basic items of the system.

System > System

Set the basic items in the System.

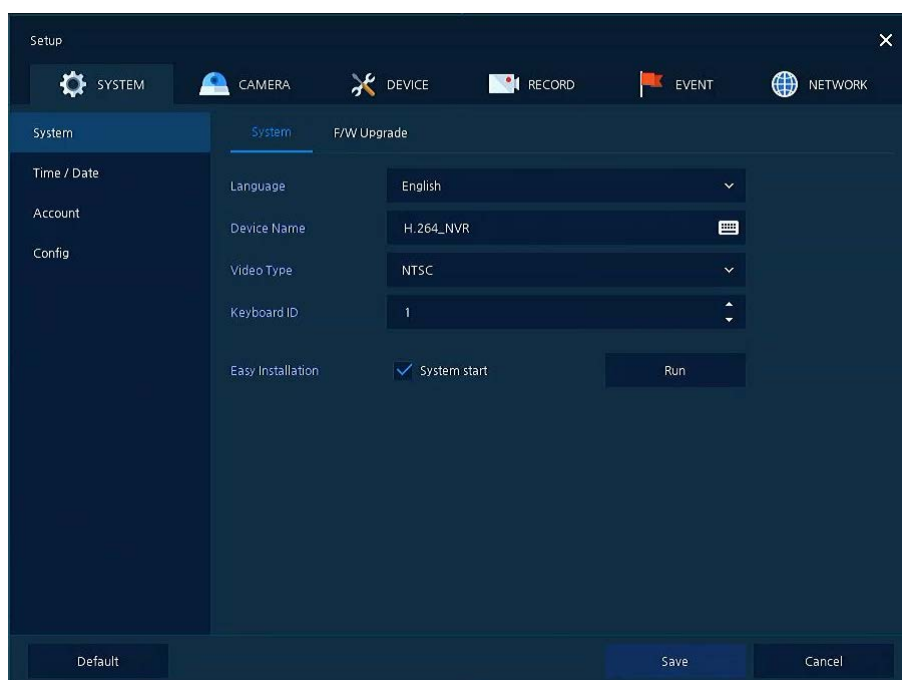

**Figure 4-3 SYSTEM > System > System**

**Table 4-4 SYSTEM > System > System Item and Description**

No.	Name	Function
1	Language	Set the system language.
2	Device Name	Enter the device name (Only English is possible).
3	Video Type	Select image standard types (NTSC, PAL).
4	Keyboard ID	Select keyboard ID (1~255).
5	Easy Installation	Select System start to run Easy Installation in starting the system.
6	Run	Run Easy Installation.



If change video type, system will reboot and all setup go to factory default.

## System > F/W Upgrade

Set the upgraded items of the system.

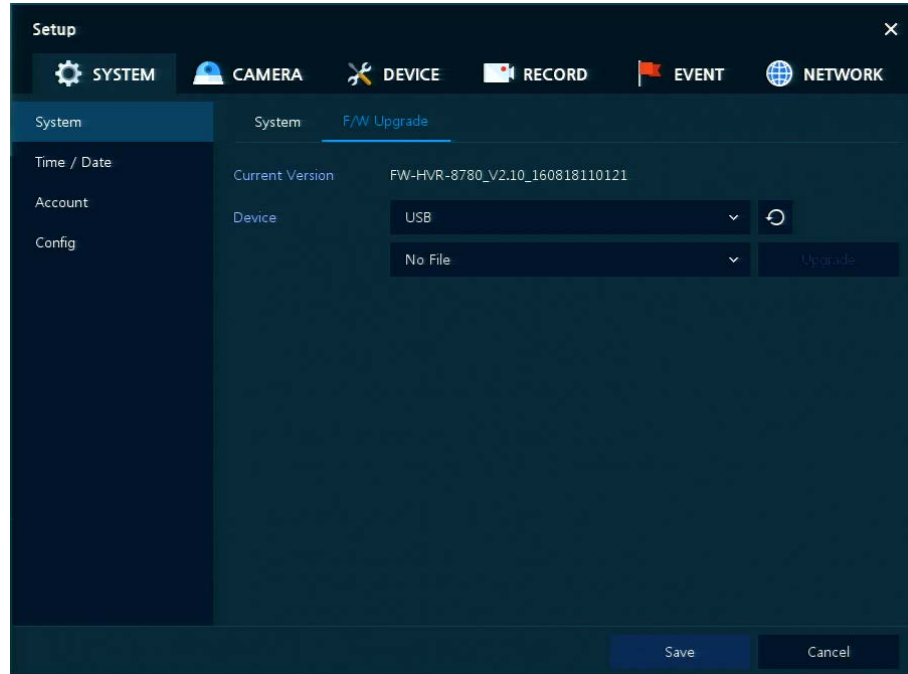

Figure 4-4 SYSTEM > System > F/W Upgrade

Table 4-5 SYSTEM > System > F/W Upgrade Item and Description

No.	Name	Function
1	Current Version	Displaying the present firmware version.
2	Device	Connect USB memory that has files to upgrade to the USB port, select files to upgrade.

### Note

- If firmware version in the USB drive is lower than present system version, system does not display the firmware in the USB drive.
- To upgrade through network, recorder must have HDD.

## 4.2.2 Time/Date

Set the date, time, and holidays of the system.

### Time/Date > Time/Date

Set the date, time, and holidays of the system.

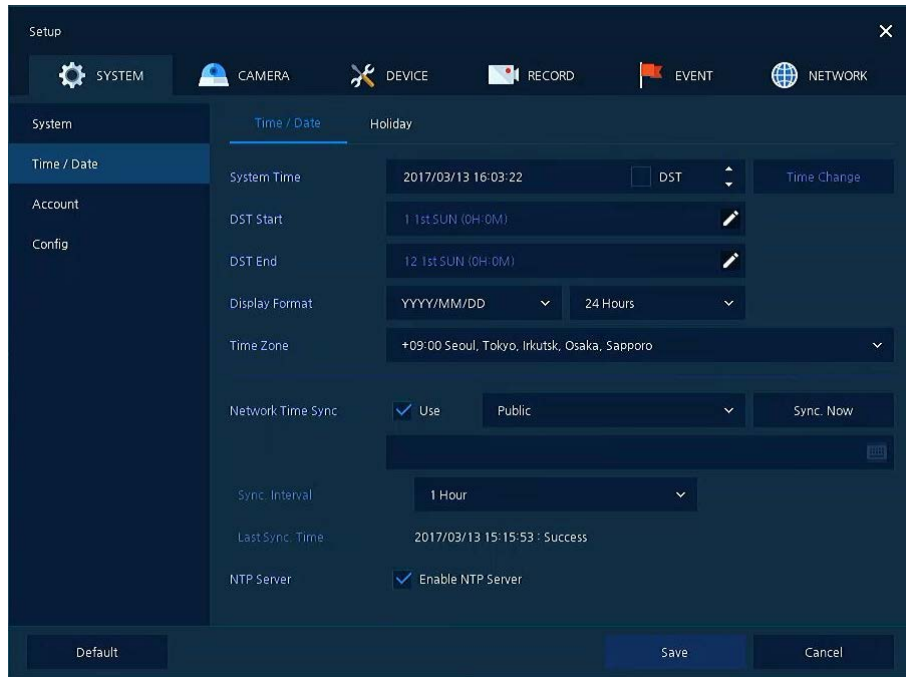

Figure 4-5 SYSTEM > Time/Date > Time/Date

Table 4-6 SYSTEM > Time/Date > Time/Date Item and Description

No.	Name	Function
1	System Time	Set the date and time. <ul style="list-style-type: none"> <li>DST: Select whether to use summer time.</li> <li>Time change: Save changed time.</li> <li>If time changed to older time, time overlap list will be created and user can select the list from search and backup menu. Time overlap list can be created up to 20 lists a day.</li> </ul>
2	DST Start	Set the starting date of summer time
3	DST End	Set the ending date of summer time
4	Display Format	Select the format to present date and time.
5	Time Zone	Select time zone.
6	Network Time Sync	For using a specific network time server, click the Use checkbox and enter the server address. <ul style="list-style-type: none"> <li>Sync. Interval: Select synchronization period (1~7-hour)</li> <li>Last Sync. Time: Displaying the final synchronized time</li> </ul>
7	NTP Server	System run NTP (Network Time Protocol) server for NTP client.



## Time/Date > Holiday

Set holidays of the system.

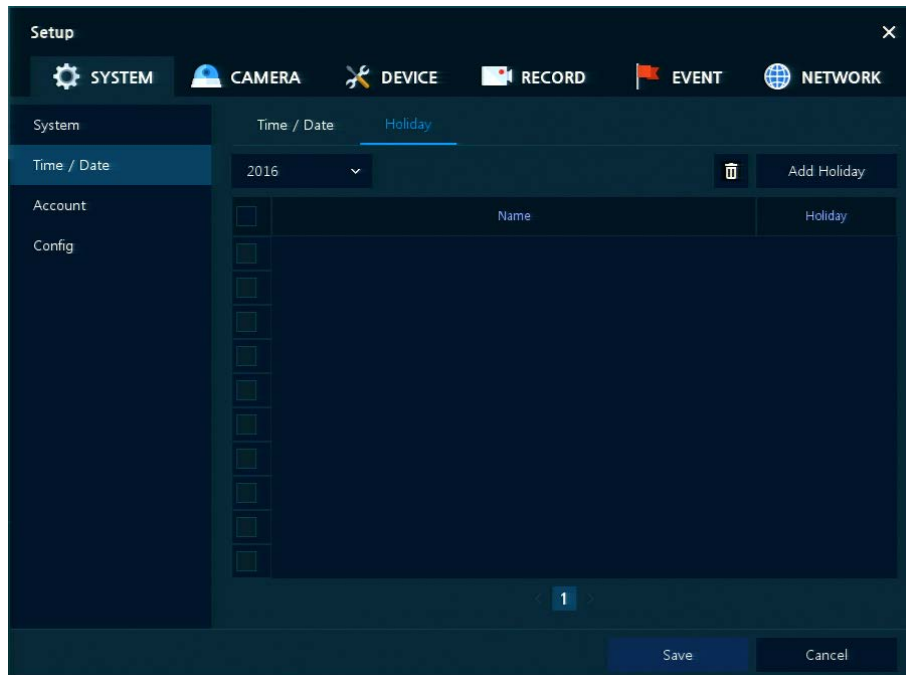



Figure 4-6 SYSTEM > Time/Date > Holiday

Table 4-7 SYSTEM > Time/Date > Holiday Item and Description

No.	Name	Function
1	Year	Select years to set holidays.
2		Delete selected holidays.
3	Add Holiday	Add holidays.
4	List	Display added holiday lists.

Clicking **Add Holiday** displays holiday addition screen like below.

**Figure 4-7 SYSTEM > Time/Date > Holiday > Add Holiday**

**Table 4-8 SYSTEM > Time/Date > Holiday > Add Holiday Item and Description**

No.	Name	Function
1	Name	Enter the holiday name.
2	Date	Display chosen date.
3	Type	Select the holiday types. e.g.,) Selecting <b>Relative</b> and <b>1, first</b> , and <b>Sun</b> , which designates annual January of the 1 <sup>st</sup> Sunday as a holiday.
4	Calendar	Select the holiday to add.

### 4.2.3 Account > User

Set the user's account of the system.

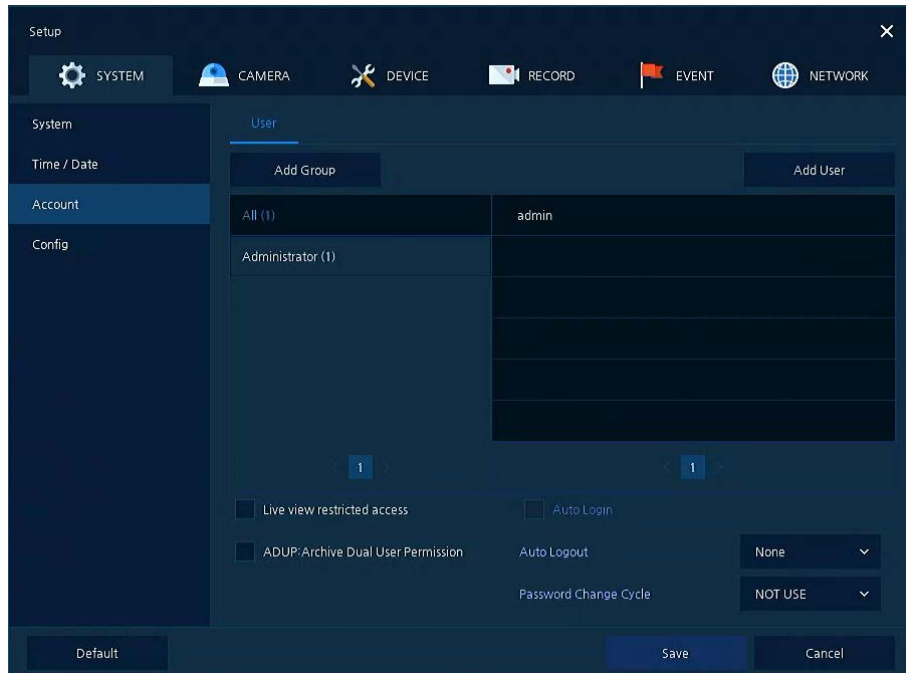

Figure 4-8 SYSTEM > Account > User

Table 4-9 SYSTEM > Account > User Item and Description

No.	Name	Function
1	Add Group	Add users' group.
2	Add User	Add users.
3	Group List	Display a total group list.
4	User List	Display user lists across groups.
5	Live view restricted access	Do not display live video if log it out.
6	ADUP(Archive Dual User Permission)	Two users should access to search, playback and back-up. The user should have administrator permission.
7	Auto Login	When a user selected, Auto Login menu will be activated and if click Auto Login check box, system will be auto login to the selected user.
8	Auto Logout	Select automatic logout time (Null, 1 min, 2 min, 3 min, 4 min, 5 min, 6 min, 7 min, 8 min, 9 min, 10 min, and 30 min).
9	Password Change Cycle	If enable, user should change the password periodically.

Press **Add Group** button, then **Add Group** screen displays.

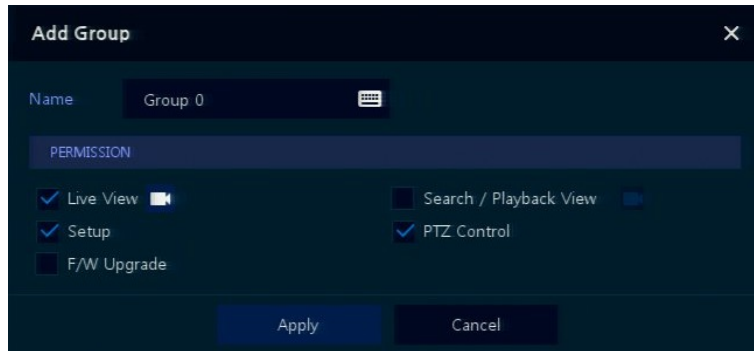



Figure 4-9 SYSTEM > Account > User > Add Group

Table 4-10 SYSTEM > Account > User > Add Group Item and Description

No.	Name	Function
1	Name	Enter the group name.
2	PERMISSION	Select items to permit access.
3		Select channels to permit access.

Press **Add User** button, then **Add User** screen displays.

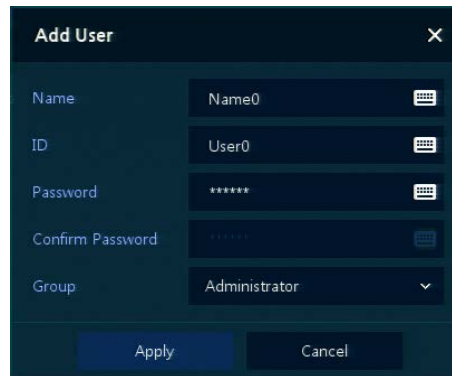

Figure 4-10 SYSTEM > Account > User > Add User

Table 4-11 SYSTEM > Account > User > Add User Item and Description

No.	Name	Function
1	Name	Enter the user name.
2	ID	Enter the user ID.
3	Password	Enter the password.
4	Confirm Password	Confirm the password.
5	Group	Select to the group to which belongs.

## 4.2.4 Configuration (Config)

Set Export/Import and Factory Default of the system.

Config > Export/Import

Through a save medium, users may apply information set to other devices identically.

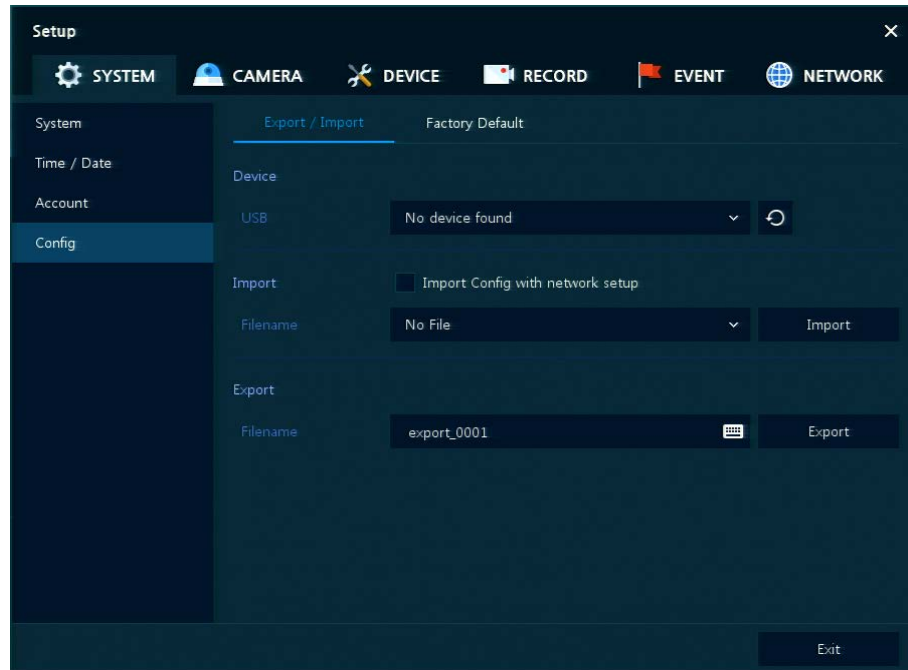

Figure 4-11 SYSTEM > Config > Export/Import

Table 4-12 SYSTEM > Config > Export/Import Item and Description

No.	Name	Function
1	Device	Select an exterior connector with USB. <ul style="list-style-type: none"> <li>USB: Displays the USB device connected.</li> <li>Refresh button: Re-recognize the device.</li> </ul>
2	Import	Apply information saved in USB to the device. <ul style="list-style-type: none"> <li>Import Config with network setup: The network setting information is brought from the setting information.</li> <li>Import button: The file in USB is brought to the designated device.</li> </ul>
3	Export	Save the set information in the USB. <ul style="list-style-type: none"> <li>Export Config with network setup: Save the information including network setting one from the setting information to be exported.</li> </ul> Export button: Save the set information in the USB.

## Config > Factory Default

Default the setting value of the device.

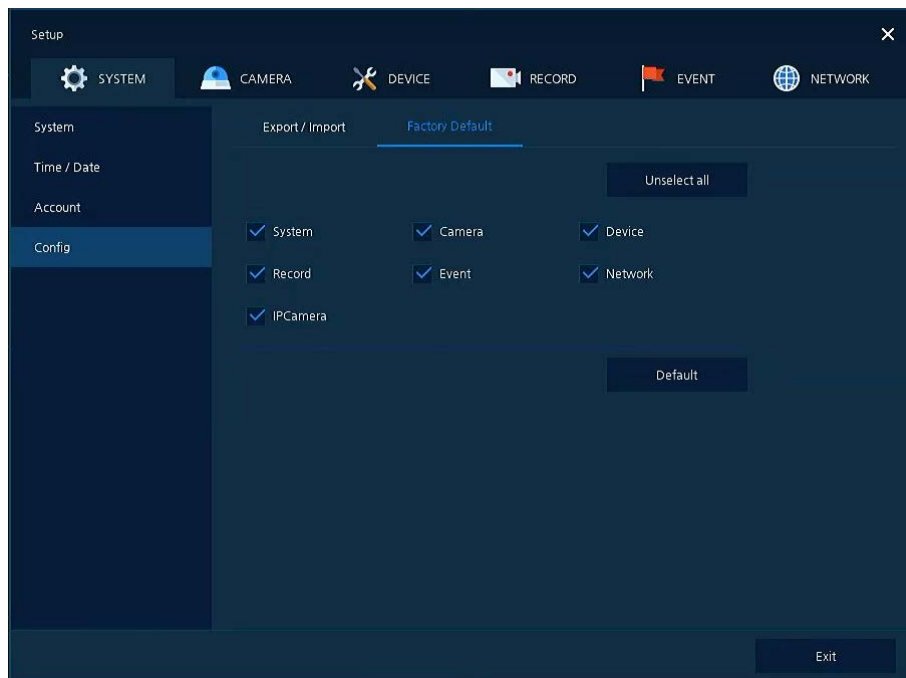

Figure 4-12 SYSTEM > Config > Factory Default

Table 4-13 SYSTEM > Config > Factory Default Item and Description

No.	Name	Function
1	Select All /Unselect All	Select/deselect all items to be defaulted.
2	Default Item	Select/deselect related items to be defaulted.
3	Default button	Default the system to the basics.

## 4.3 CAMERA

In **CAMERA** section, set the camera to be connected with the device.

### 4.3.1 Basic

Set the fundamental functions of camera and audio.

#### Basic > Basic

Set the basic items of camera by channels.

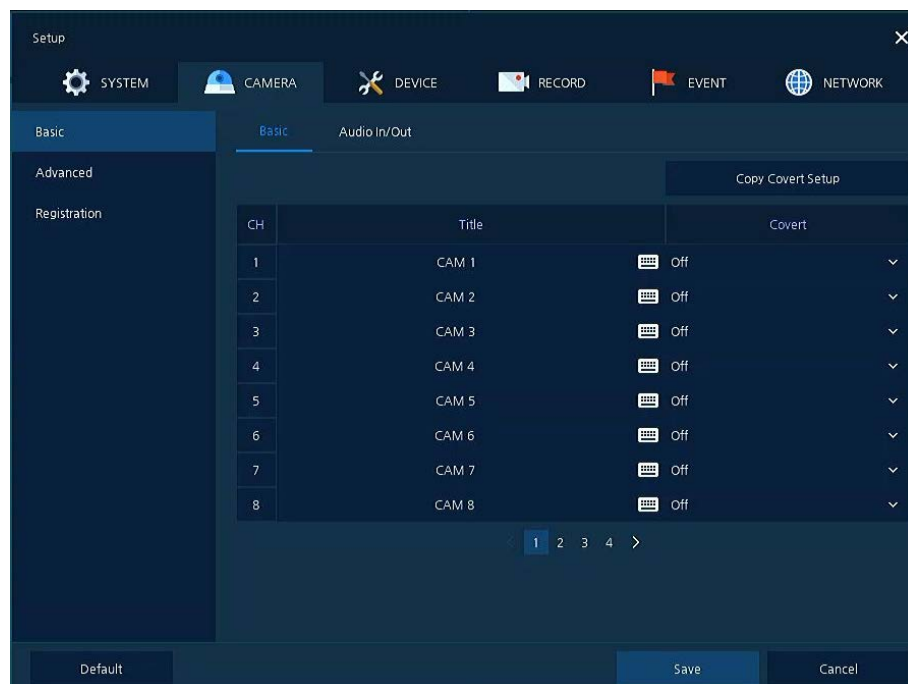
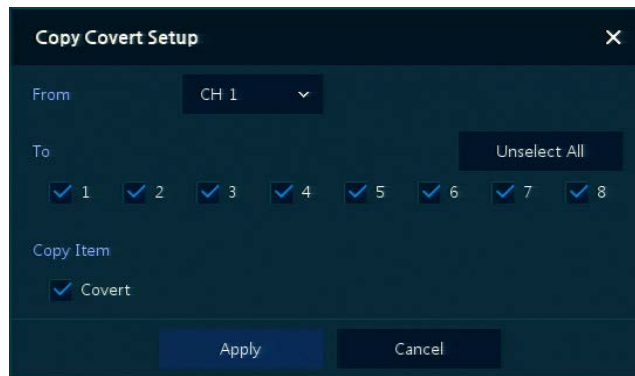

**Figure 4-13 CAMERA > Basic > Basic**

**Table 4-14 CAMERA > Basic > Basic Item and Description**

No.	Name	Function
1	CH	Display the channel name.
2	Title	Enter the camera name of relevant channels.
3	Covert	Select images to be shown in the Live screen by channels and whether to mark a status message or not (Off, Video Only, Video/State All).
4	Copy Covert Setup	In Covert, set items can be duplicated to other channels.

Press **Copy Covert Setup** button, then **Copy Covert Setup** screen displays.



**Figure 4-14 CAMERA > Basic > Basic > Copy Covert Setup**

**Table 4-15 CAMERA > Basic > Basic > Copy Covert Setup Item and Description**

No.	Name	Function
1	From	Select a channel converted setting.
2	To	Select a channel to be copied.
3	Select All /Unselect All	Select/deselect all channels.



## Basic > Audio In/out

How to set audio of camera across channels

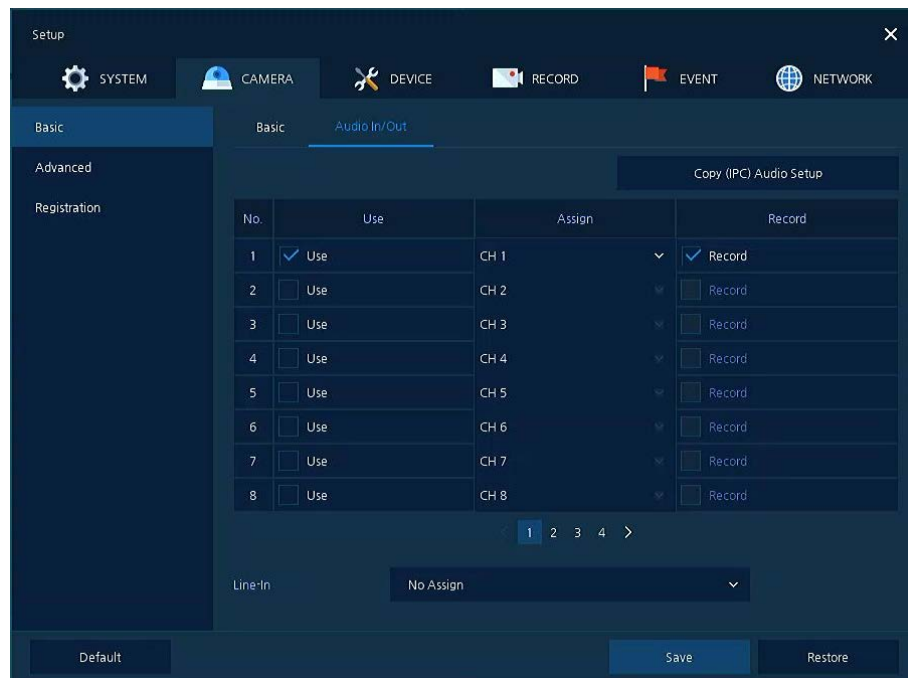

Figure 4-15 CAMERA > Basic > Audio In/Out

Table 4-16 CAMERA > Basic > Audio In/Out Item and Description

No.	Name	Function
1	No	Display channels of audio
2	Use	Select/deselect whether to use audio.
3	Assign	Select channels to be assigned audio.
4	Record	Select/deselect whether to save audio.
5	Line in	Assign recorder line in to camera channel. IP camera audio will be disabled.

### 4.3.2 Advanced

As advanced function of camera, users can set privacy.

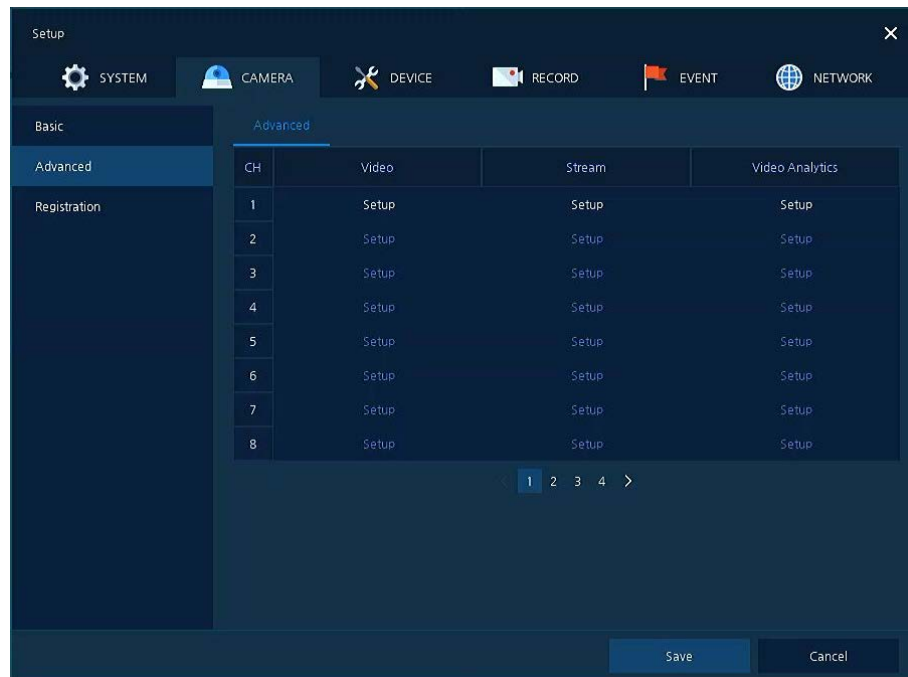

Figure 4-16 CAMERA > Advanced

Table 4-17 CAMERA > Advanced Item and Description

No.	Name	Function
1	CH	Display channels.
2	Video	Setup camera image such as Color, White Balance, WDR, AE and etc.
3	Stream	Setup camera stream such as Resolution, Framerate, Bitrate and etc.
4	Video Analytics	Setup Video Analytics function if camera supports this function.

## 4.4 DEVICE

In **DEVICE**, set the device to connect with the unit.

### 4.4.1 Display

Set matters related to a display device and live screen.

Display > Display

Set the display device.

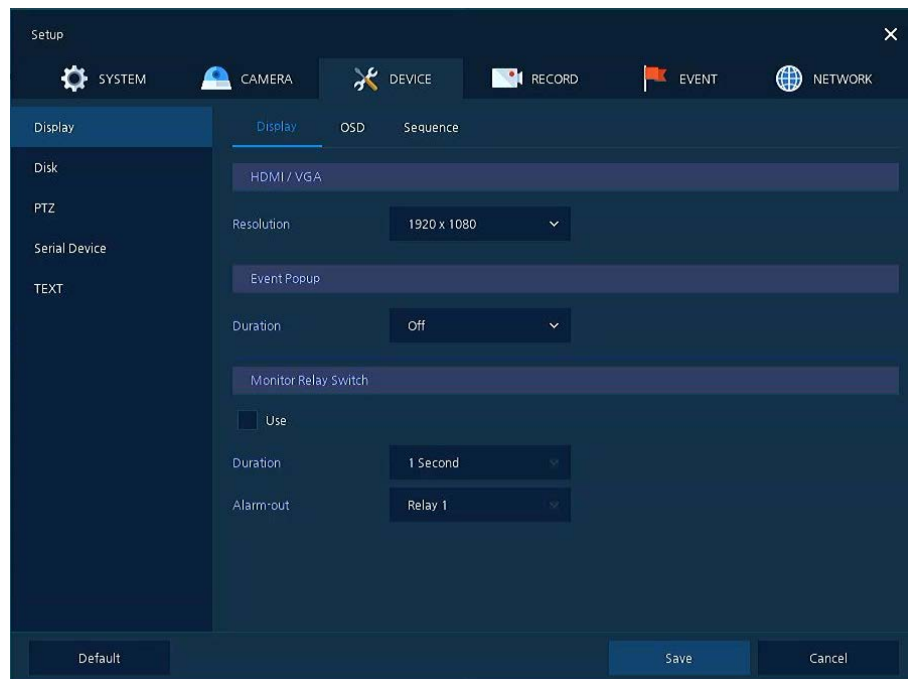

Figure 4-17 DEVICE > Display > Display

Table 4-18 DEVICE > Display > Display Item and Description

No.	Name	Function
1	HDMI/VGA	Select the resolution of the display device (1024x768, 1280x720, and 1920x1080).
2	Event Popup	Set duration of event popup screen. Screen go back to original layout after duration time
3	Monitor Relay Switch	Send alarm out when screen layout changed.

## Display > OSD

Set the OSD of the display device.

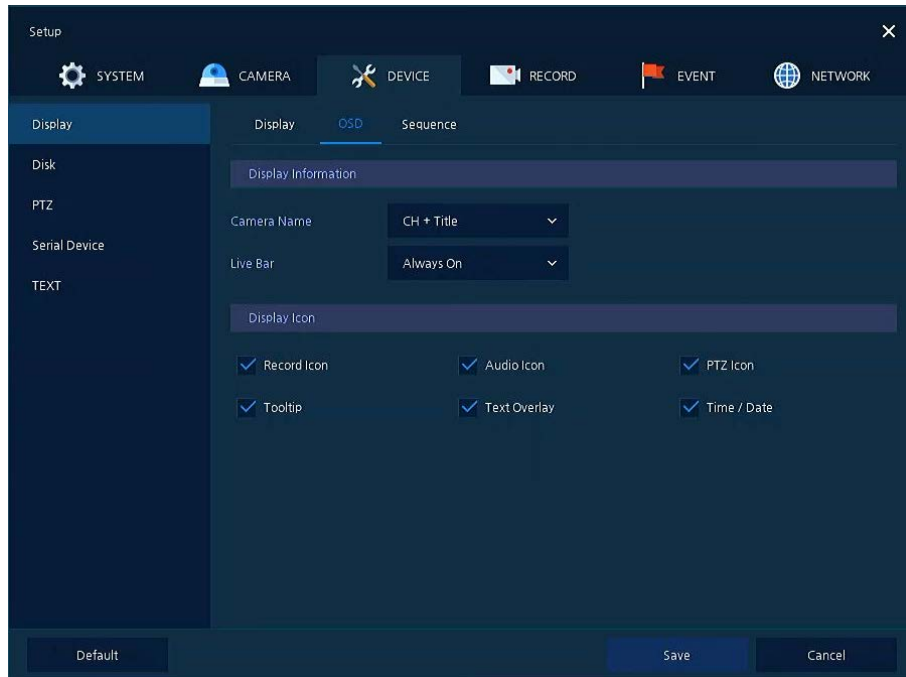

Figure 4-18 DEVICE > Display > OSD

Table 4-19 DEVICE > Display > OSD Item and Description

No.	Name	Function
1	Camera Name	Select the way to display camera in live screen (Off, CH+Title, CH).
2	Live Bar	Select the way to display the live bar (Always On, Auto Hide).
3	Display Icon	Select/deselect icons to display in the live screen.

## Display > Sequence

How to set the play sequence of live screen

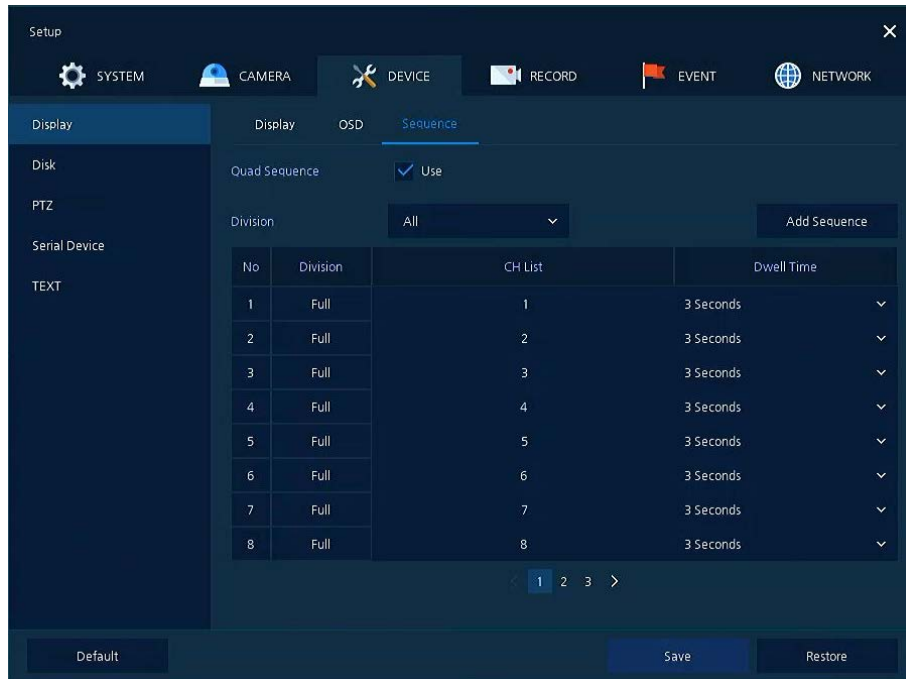

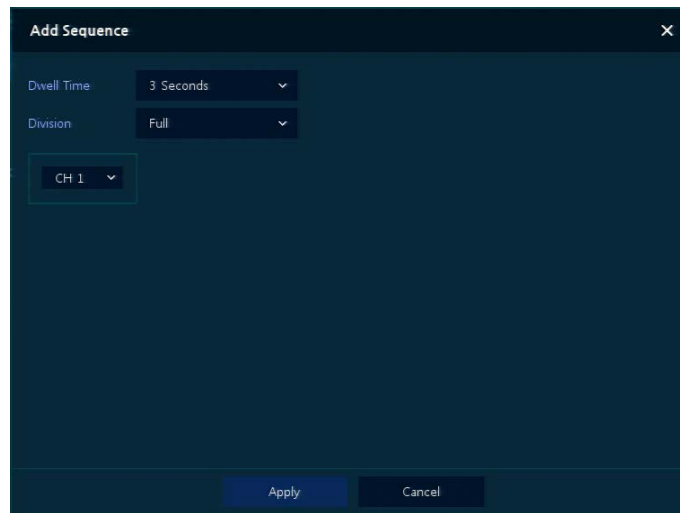

Figure 4-19 DEVICE > Display > Sequence

Table 4-20 DEVICE > Display > Sequence Item and Description

No.	Name	Function
1	Quad Sequence	Set to convert automatically as 4-partition screen on the time basis.
2	Division	Select screen partition mode to be marked in the below table (All, Full, and Quad).
3	Sequence List	Display the sequence list based on division selected value.
4	Add Sequence	Add items to be included in the play sequence.
	NO	Automatically controvert screens in number order.
	Division	Displays as full, 2X2 (Quad).
	CH LIST	Set automatic conversion CHs. In case of choosing CH3 in No. 1, CH3 is shown in advance.
	Dwell Time	Set the remaining time for automatic conversion (3 sec~30 sec)
	Default	Reverse to changed set value in default.
		Revise the list.
		Delete the list.

Clicking **Add Sequence** displays **Add Sequence** screen.



**Figure 4-20 DEVICE > Display > Sequence > Add Sequence**

**Table 4-21 DEVICE > Display > Sequence > Add Sequence Item and Description**

No.	Name	Function
1	Dwell Time	Select time to play (3 sec, 5 sec, 10 sec, 15 sec, and 30 sec).
2	Division	Select the partition screen to play (Full, Quad).
3	Channel Selection	Select channels to play.

## 4.4.2 Disk > Setup

### Disk > Setup

The way to set the disk

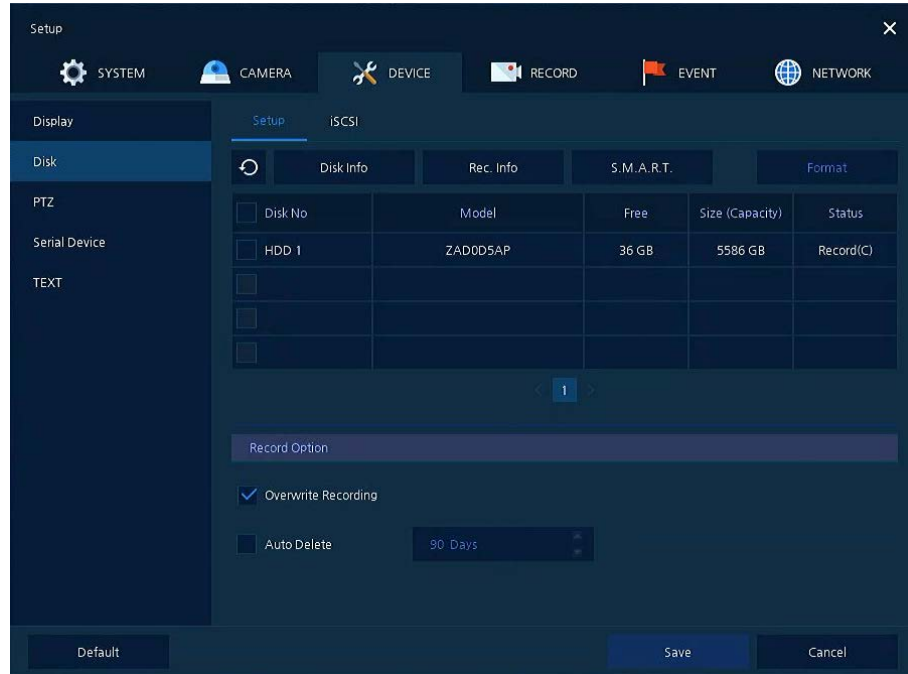



Figure 4-21 DEVICE > Disk > Setup

Table 4-22 DEVICE > Disk > Setup Item and Description

No.	Name	Function
1		Refresh disk information.
2	Disk Info	Display the basic disk information in disc list. <ul style="list-style-type: none"> <li>Model: disk model name</li> <li>Free: disk capacity to save</li> <li>Size (Capacity): total disk capacity</li> <li>Status: disk status</li> </ul>
3	Rec. Info	Display saved disk information in disc list. <ul style="list-style-type: none"> <li>Start Recording Time: starting time for saving information in the disk</li> <li>End Recording Time: ending time to stop saving information in the disk</li> <li>Status: disk status</li> </ul>
4	S.M.A.R.T.	Display S.M.A.R.T. information in disc list. <ul style="list-style-type: none"> <li>Model: disk model name</li> <li>Temp.: disk temperature</li> <li>Alive Time: running time after turning on the disk</li> <li>S.M.A.R.T.: a presenter of disk's malfunction</li> </ul>
5	Disk List	Display the disk list select/deselect disc to be formatted
6	Format	Format the disk selected.

No.	Name	Function
7	Overwrite Recording	Select/deselect to rewrite new data on the existing disk in case of insufficient saving space remained
8	Auto Delete	Select/deselect to use the function to delete saved data automatically (1-365 days).

## Disk > iSCSI

The way to set the iSCSI

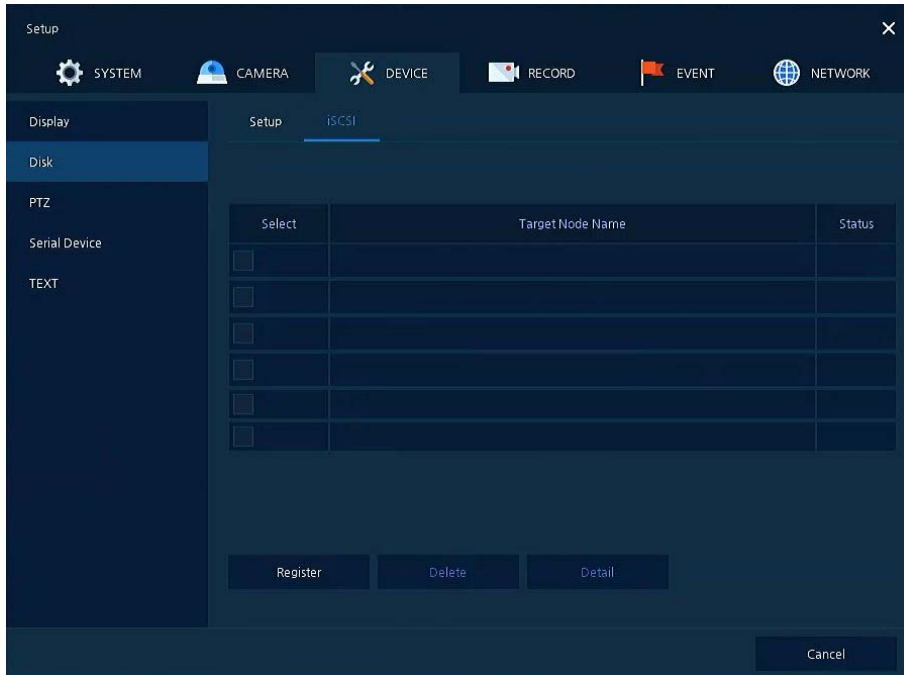

. Figure 4-22 DEVICE > Disk > iSCSI

Table 4-23 DEVICE > Disk > iSCSI Item and Description

No.	Name	Function
1	Select	Display iSCSI device number. Up to 6 devices support.
2	Target Node Name	Display registered IQN (iSCSI Qualified Name).
3	Status	Display connection status (Good or Bad).
4	Register	Opens a pop-up menu for iSCSI registration.
5	Delete	Delete registered iSCSI storage.
6	Detail	Display selected iSCSI IP address and port number.



**iSCSI register screen.**

No.	Name	Function
1	Target Address Target Port HTTP Port	Input IP address and ports for iSCSI
2	Discover	Click to search iSCSI storage.
3	Enable CHAP	Select Enable CHAP if iSCSI use CHAP authentication.
4	User Name	Enter user name of CHAP authentication.
5	Password	Enter password of CHAP authentication.
6	Add	Click to register the discovered iSCSI storage. User can add iSCSI one by one. If recorder does not have any internal HDD, the recorder reboots automatically and completes mounting process.

### 4.4.3 PTZ > PTZ

To use PTZ Function of the device, users need to match ID, protocol, and speed with each camera.

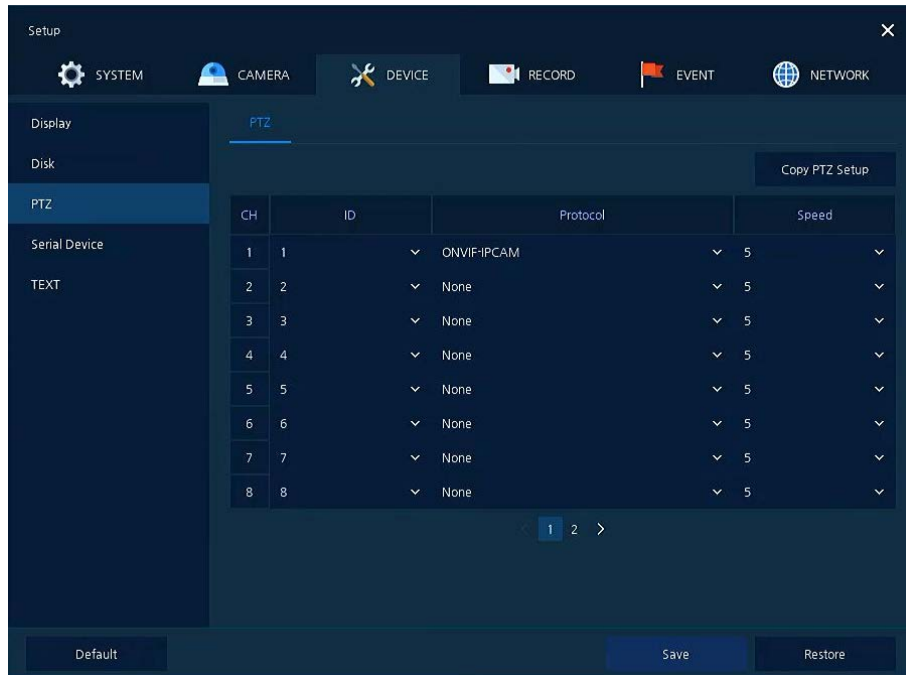

Figure 4-23 DEVICE > PTZ > PTZ

Table 4-24 DEVICE > PTZ > PTZ Item and Description

No.	Name	Function
1	Copy PTZ Setup	Apply setting history to all or selected channels in the same way.
2	CH	Display channels.
3	ID	Select camera ID connected to relevant channels (1-255).
4	Protocol	Select protocol of camera connected to relevant channels.
5	Speed	Select pan-tilt of camera connected to relevant channels (1-5).

**Note**

- For more information about camera ID, protocol information, and details, see Instruction of relevant PTZ Function camera.

#### 4.4.4 Serial Device > Serial Device

Users need to set Serial Device to connect PTZ camera, USB device with the unit.

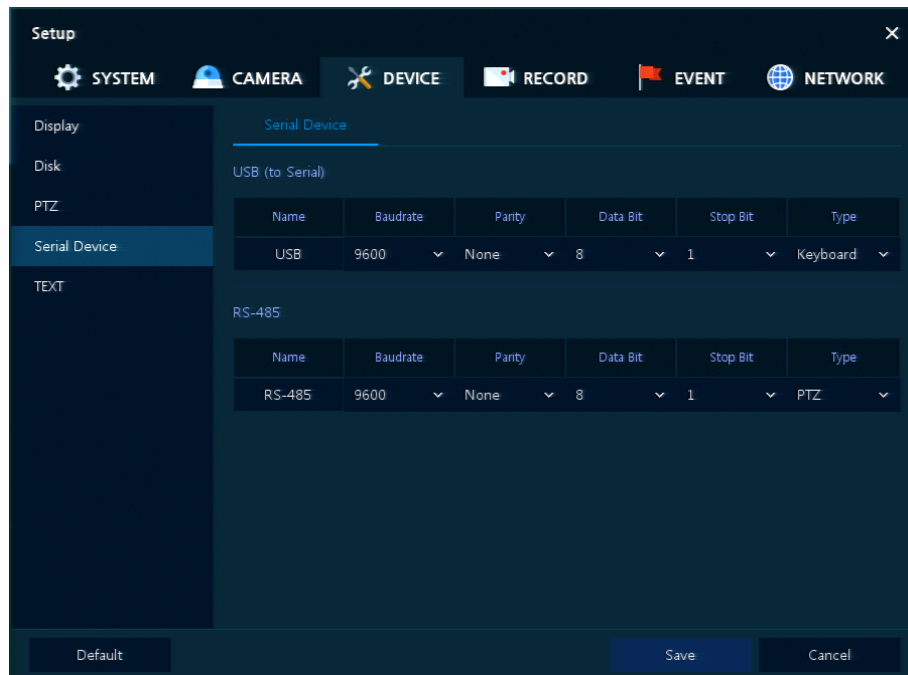

Figure 4-24 DEVICE > Serial Device > Serial Device

Table 4-25 DEVICE > Serial Device > Serial Device Item and Description

No.	Name	Function
1	USB (to Serial)	Set communication transmission value of USB device.
2	RS-485	Set communication transmission value of RS-485 connector.

Set the communication transmission value based on the device to be connected and select the medium (PTZ, keyboard, or Text device).

## 4.4.5 Text > Text

Set the input device such as ATM or POS, etc.

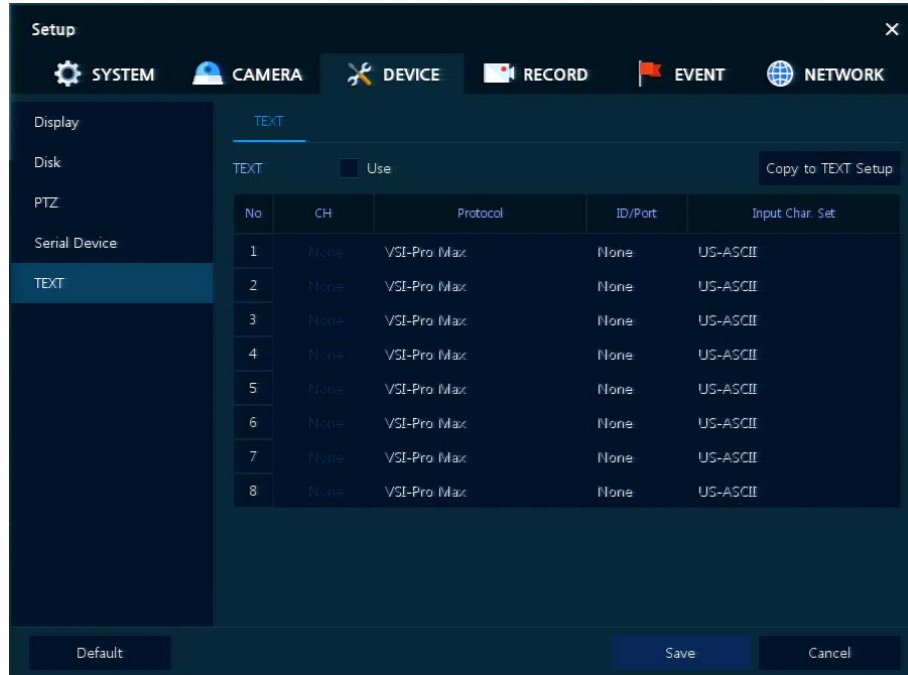
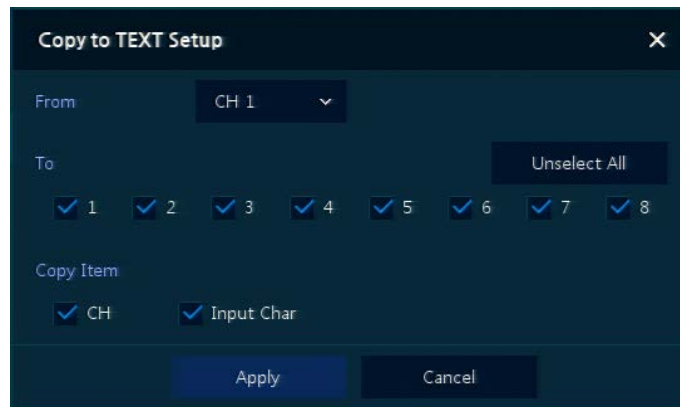

Figure 4-25 DEVICE > Text > Text

Table 4-26 DEVICE > TEXT > TEXT Item and Description

No.	Name	Function
1	Use	Select/deselect whether to use text function.
2	CH	Select camera channels to connect with the text input device.
3	Protocol	Select protocol to correspond with the text input device.
4	ID. Port	Select ID and port no. to correspond with the text input device.
5	Input Char. Set	Select a character format of the text input device.
6	Copy to Text Setup	As for connecting multiple units, duplicate set value to others.

Press **Copy to Text Setup** button, then **Copy to Text Setup** screen displays.



**Figure 4-26 DEVICE > Text > Text > Copy to Text Setup**

**Table 4-27 DEVICE > TEXT > Text > Copy to Text Setup Item and Description**

No.	Name	Function
1	From	Select channels set.
2	To	Select the device to be copied.
3	Select All /Unselect All	Select/deselect all channels.
4	Copy Item	Select/deselect items to be copied.

## 4.5 RECORD

In **RECORD**, users may set matters related to recording.

### 4.5.1 Schedule > Schedule

Recording types can be set across channels and time.

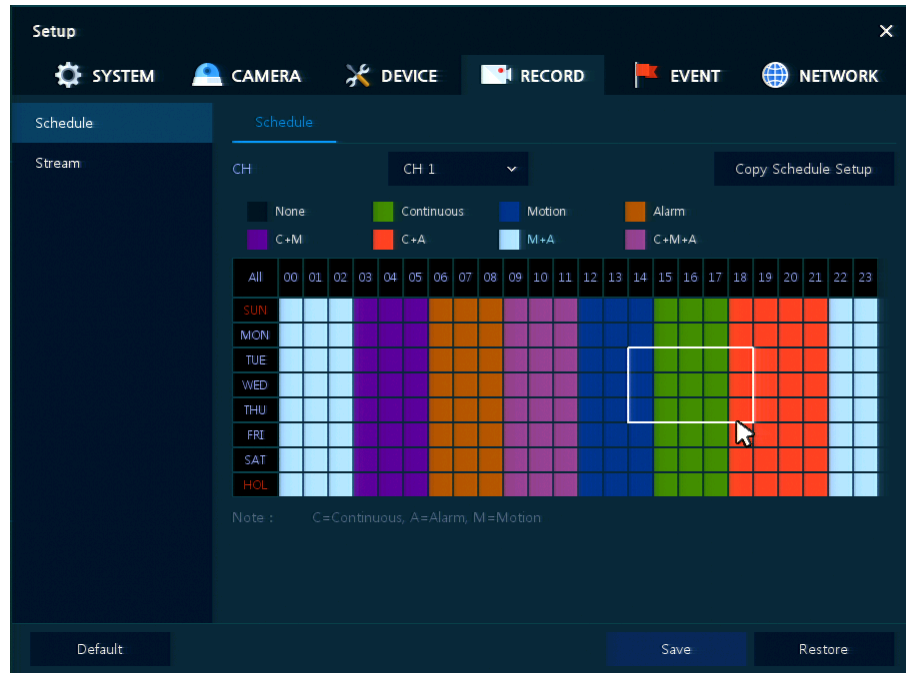









Figure 4-27 RECORD > Schedule > Schedule

Table 4-28 RECORD > Schedule > Schedule Item and Description

No.	Name	Function
1	CH	Select channels to set schedules.
2	Schedule Type Selection	Select the types of schedules.
3	Schedule Table	Display the schedule users set.
4	Drag Field	Display the area dragged with a mouse.
5	Copy Schedule Setup	Copy set recording schedule to other channels.

The function of each scheduling type involves:

**Table 4-29 Function of each scheduling type**

Color	Scheduling type	Function
	None	Do not record.
	Continuous	Record on consecutive mode when time set.
	Motion	Record on event recording mode when motion sensitive event occurs.
	Alarm	Record on event recording mode when alarm occurs.
	C+M	Record on event recording mode when motion sensitive event occurs during consecutive mode recording.
	C+A	Record on event recording mode when alarm occurs during consecutive mode recording.
	M+A	Record on event recording mode when only alarm and motion sensitive event occur.
	C+M+A	Record on event recording mode when only alarm and motion sensitive event occur during consecutive mode recording.

The way to schedule recording across channels

- 1 Select channels to schedule.



- 2 Select items in scheduling types.

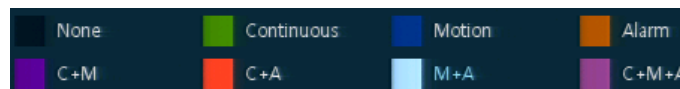

- 3 Position the mouse to the schedule table.

- 4 Drag the area to be scheduled with a mouse.

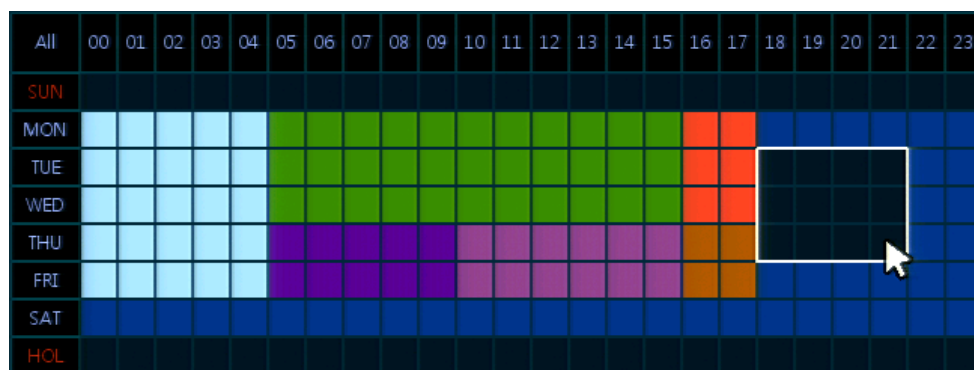

- 5 Selected field is presented as scheduling type colors.

- 6 Click **Copy Schedule Setup** if you want to copy the schedule to other channels.

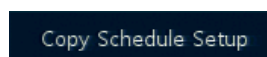

7 **Copy Schedule Setup** screen displays.

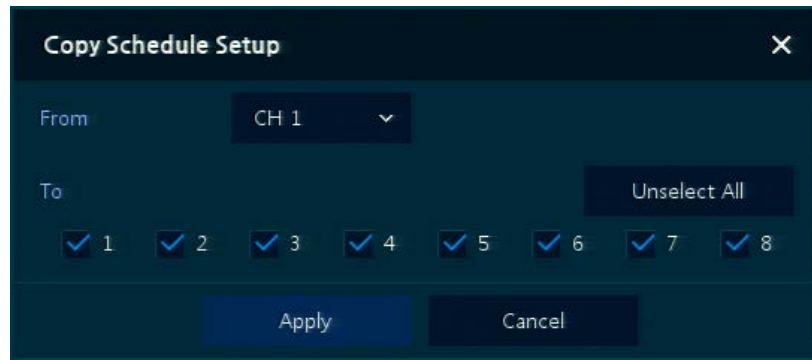

8 Select channels to be copied.



9 Select channels to apply copied content.



10 Copy the schedule by pressing **Apply**.



11 Press **Save** to save the schedule.



## 4.5.2 Stream

To set the image resolution when event occurs across channels or general recording is in process.

### Stream > Main Stream

To set the image quality and resolution of Main Stream

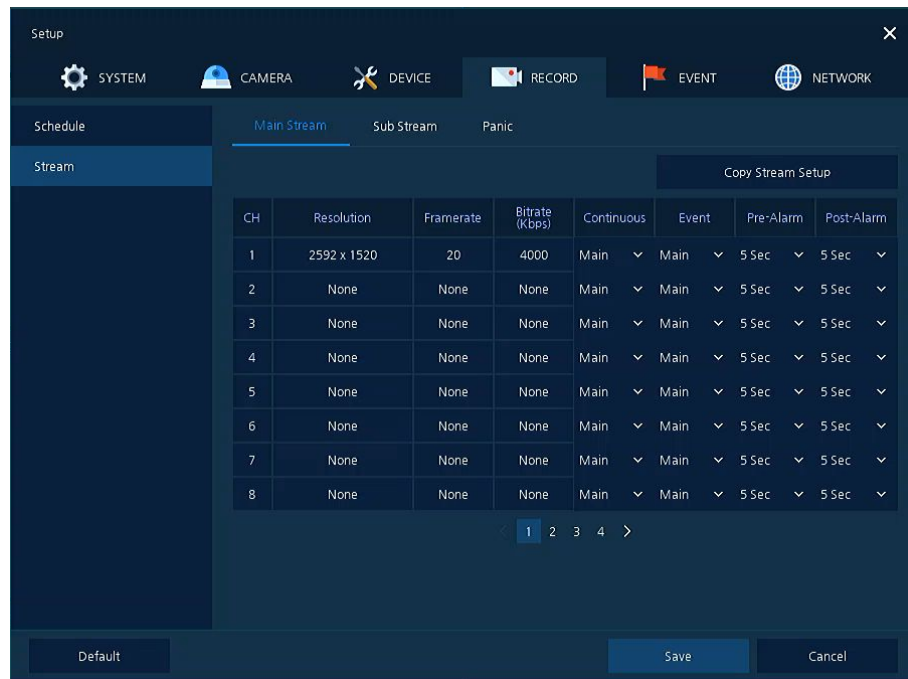
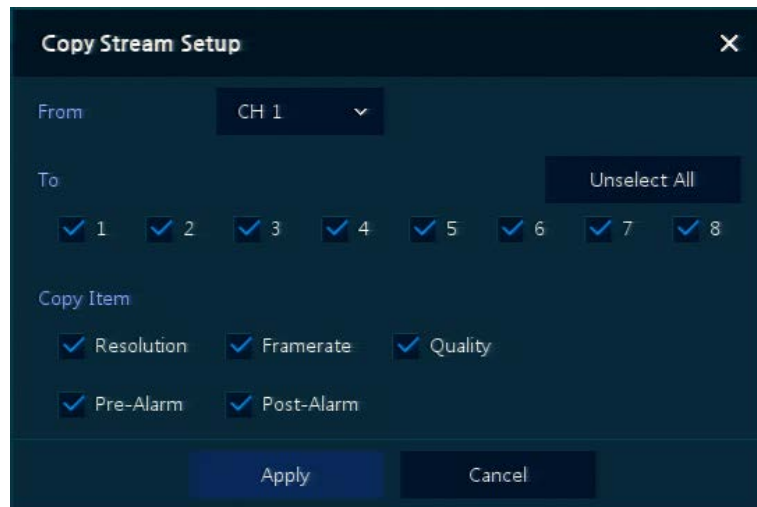

Figure 4-28 RECORD > Stream > Main Stream

Table 4-30 RECORD > Stream > Main Stream Item and Description

No.	Name	Function
1	CH	Display channels.
2	Resolution Framerate Bitrate	Show camera main stream setup status.
3	Continuous	Select recording stream in case of Continuous mode.
4	Event	Select recording stream in case of Event mode.
5	Pre-Alarm	Start recording before set time, if event occurs (null, 1 sec, 2 sec, 3 sec, 4 sec, and 5 sec).
6	Post-Alarm	Recording after set time until event ends (null, 5 sec, 10 sec, 30 sec, 1 min, 5 min, and 10 min).
7	Copy Stream Setup	Copy main recording image set value to other channels.

Clicking **Copy Stream Setup** opens **Copy Stream Setup**.



**Figure 4-29 RECORD > Stream > Main Stream > Copy Stream Setup**

**Table 4-31 RECORD > Stream > Main Stream > Copy Stream Setup Item and Description**

No.	Name	Function
1	From	Select the channel set.
2	To	Select the device to be copied.
3	Select All /Unselect All	Select/deselect all channels.
4	Copy Item	Select/deselect items to be copied.

## Stream > Sub Stream

To set the image quality and resolution of Sub Stream

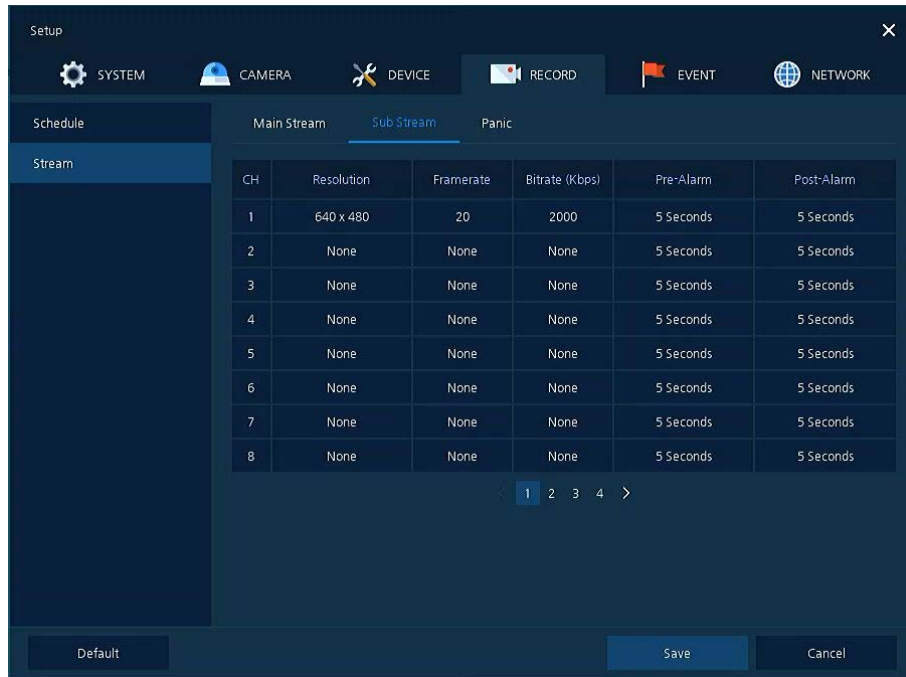

Figure 4-30 RECORD > Stream > Sub Stream

Table 4-32 RECORD > Stream > Sub Stream Item and Description

No.	Name	Function
1	CH	Display channels.
2	Resolution Framerate Bitrate	Show camera second stream setup status.
3	Pre-Alarm	Start recording before set time, if event occurs.
4	Post-Alarm	Recording after set time until event ends.

## Stream > Panic

How to set immediate recording

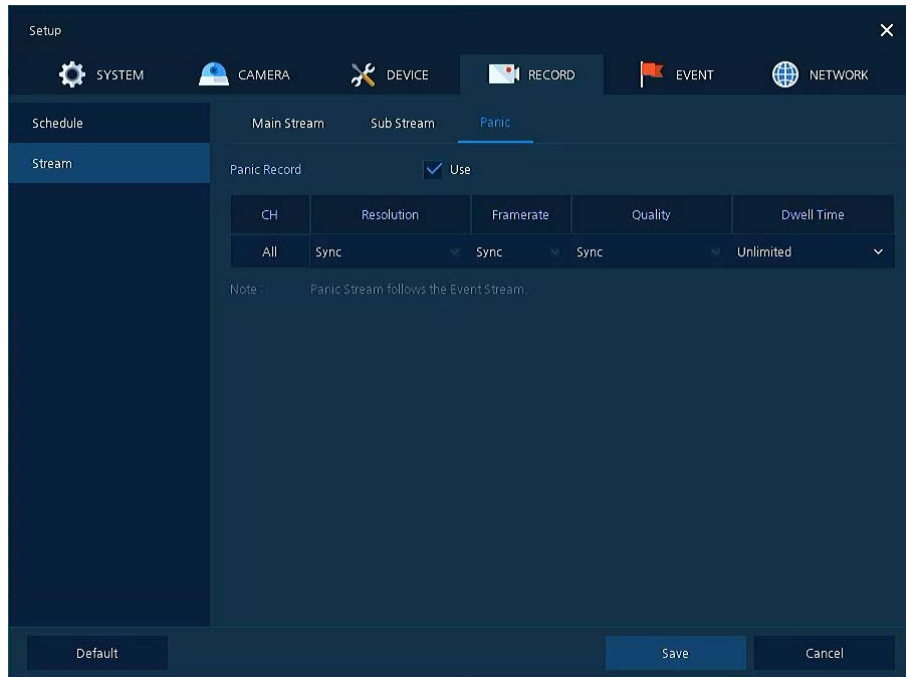

Figure 4-31 RECORD > Stream > Panic

Table 4-33 RECORD > Stream > Panic Item and Description

No.	Name	Function
1	Panic Record	Select/deselect to use immediate recording function.
2	CH	Display channels.
3	Resolution Frame rate Quality	Panic recording stream follows the Event stream.
4	Dwell Time	Select recording duration (No limits, 10 sec, 30 sec, 1 min, 5 min, 10 min, and 30 min).

## 4.6 EVENT

In **EVENT**, users may set each event of the device.

### 4.6.1 System/Disk

To set the system and disk event

System/Disk > System

To set the system event of the device

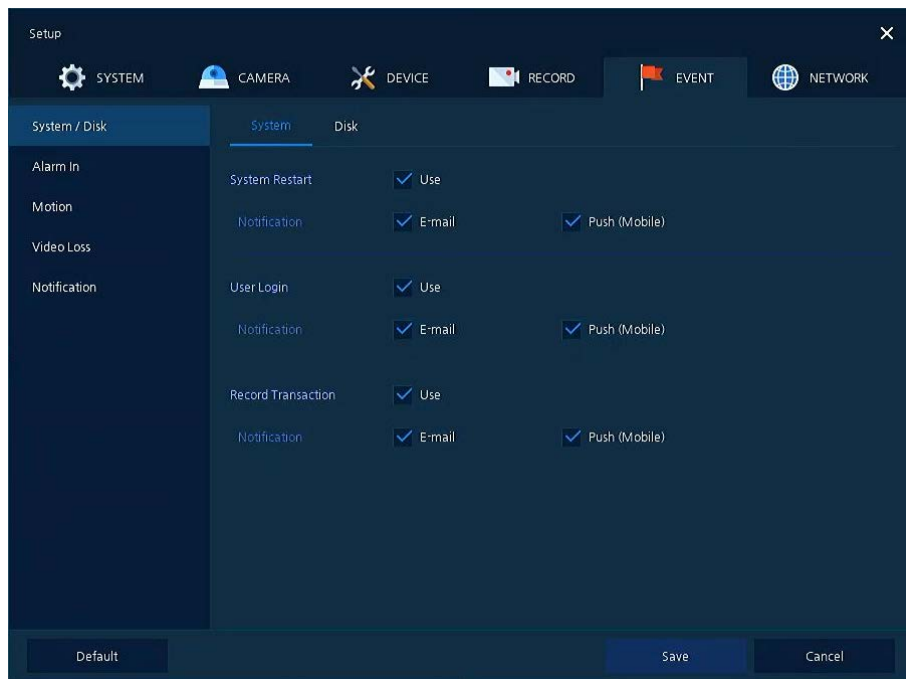

Figure 4-32 Event > System/Disk > System

Table 4-34 Event > System/Disk > System Item and Description

No.	Name	Function
1	System Restart	Select/deselect whether to use system restart event.
2	Notification	Select/deselect whether to use mailing or mobile push in case of event.
3	User Login	Select/deselect whether to use user-login event.
4	Record Transaction	Select/deselect whether to use record transaction event.

## System/Disk > Disk

To set disk event

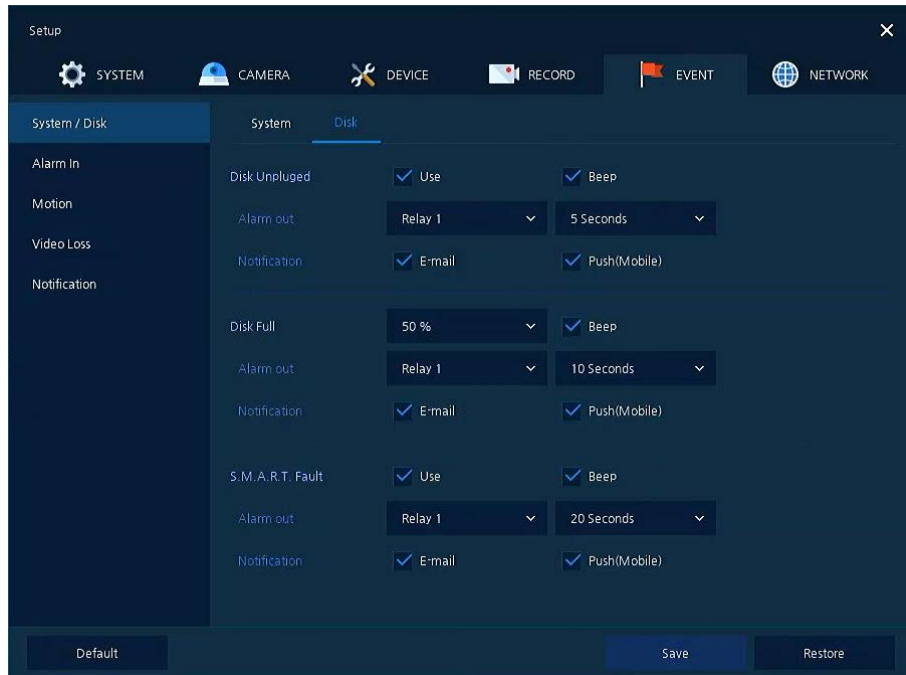

Figure 4-33 Event > System/Disk > Disk

Table 4-35 Event > System/Disk > Disk Item and Description

No.	Name	Function
1	Disk Unplugged	Select/deselect whether to use disk unplugged event
2	Beep	Select/deselect whether to use buzzer sound in case of event.
3	Alarm out	Select to end alarm time (null, Relay1-Keep, 5 sec, 10 sec, 20 sec, 30 sec, 1 min, 10 min, 30 min, and 1 hour).
4	Notification	Select/deselect whether to use mailing or mobile push in case of event.
5	Disk Full	Set disk capacity for disk full event (Off, 50%, 60%, 70%, 80%, 90%, and 100%).
6	S.M.A.R.T. Fault	Select/deselect whether to use S.M.A.R.T. Fault event of HDD.

## 4.6.2 Alarm In

To set sensor alarms and schedule

### Alarm In > Setup

To set sensor alarms

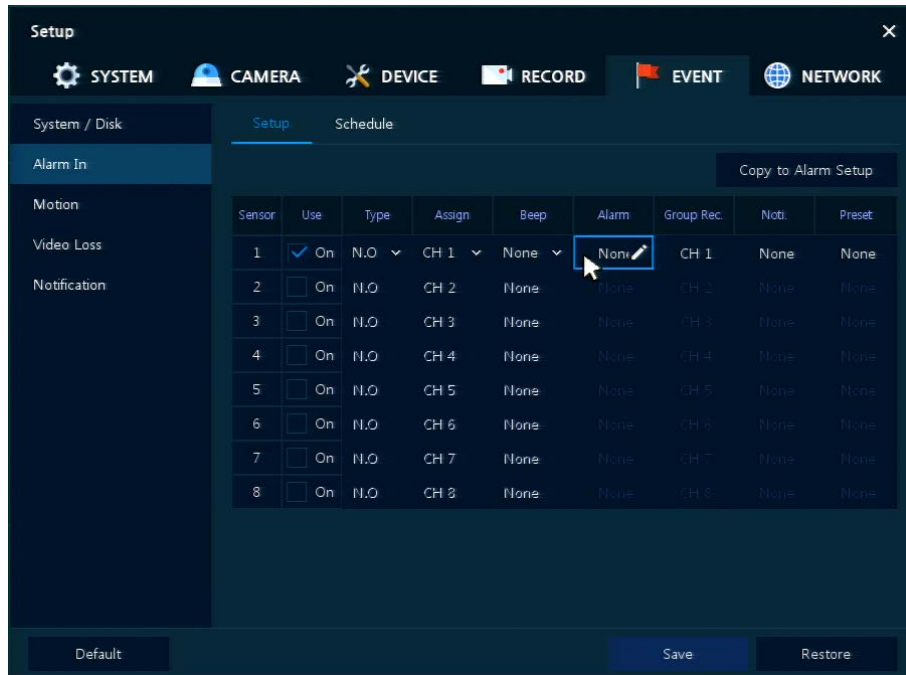

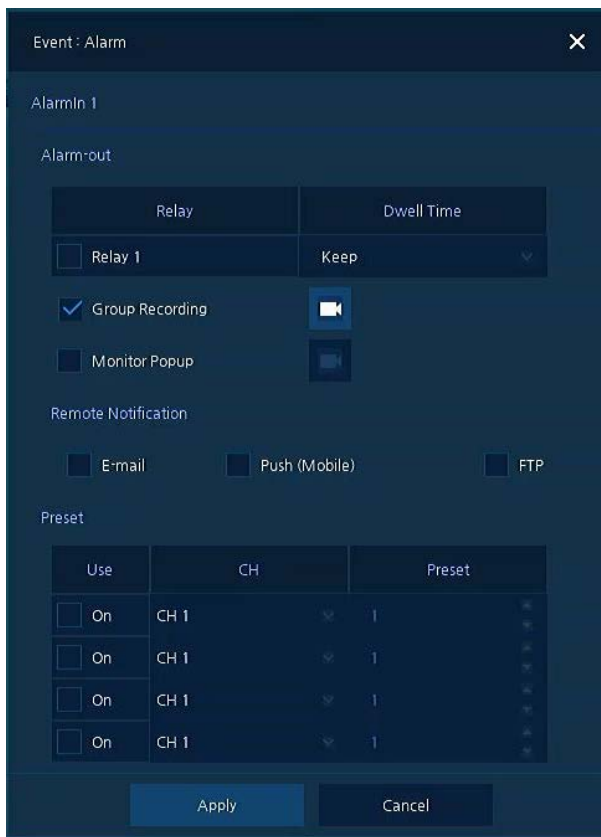

Figure 4-34 Event > Alarm In > Setup

Table 4-36 Event > Alarm In > Setup Item and Description



No.	Name	Function
1	Sensor	Display sensor numbers.
2	Use	Select/deselect whether to use alarm in the sensor.
3	Type	Select sensor types (N.O, N.C).
4	Assign	Select camera channels to designate a sensor (CH 1–4/8/16, immediate recording).
5	Beep	Select use time of buzzer sound (null, 5 sec, 10 sec, 20 sec, 30 sec, 1 min, 10 min, 30 min, and 1 hour).
6	Alarm	Set alarm output.
7	Group Rec.	Select the camera to record simultaneously.
8	Noti.	Set email notices.
9	Preset	Set preset of PTZ camera.
10	Copy to Alarm Setup	Copy alarm set value to other channels. For more information about set value copy, see section "4.5.2 Stream > Main Stream in Stream."

Placing your mouse on **Alarm, Group Rec, Noti., Preset** and clicking editing Icon (  ) in right corner displays Event: Alarm screen.



**Figure 4-35 Event > Alarm In > Setup > Event: Alarm**

**Table 4-37 Event > Alarm In > Setup > Event: Alarm Item and Description**

No.	Name	Function
1	Alarm-out	Set the alarm. <ul style="list-style-type: none"> <li>Relay: Select/clear the Relay output checkbox.</li> <li>Dwell Time: Selecting alarm duration (Keep, 5 sec, 10 sec, 20 sec, 30 sec, 1 min, 10 min, 30 min, and 1 hour)</li> </ul>
2	Group Recording	Select/deselect whether to use Group Recording.
3		Simultaneous recording camera channel screen opens.
4	Monitor Popup	Select/deselect whether to use Monitor Popup
5		Channel selection screen opens.
6	Remote Notification	Select/deselect whether to use remote mailing, Push or FTP.
7	Preset	Preset of PTZ camera is running. <ul style="list-style-type: none"> <li>Use: Select/deselect whether to use preset.</li> <li>CH: Select channels.</li> <li>Preset: Set preset value.</li> </ul>



## Alarm In > Schedule

To schedule recording time when alarm occurs across device sensors

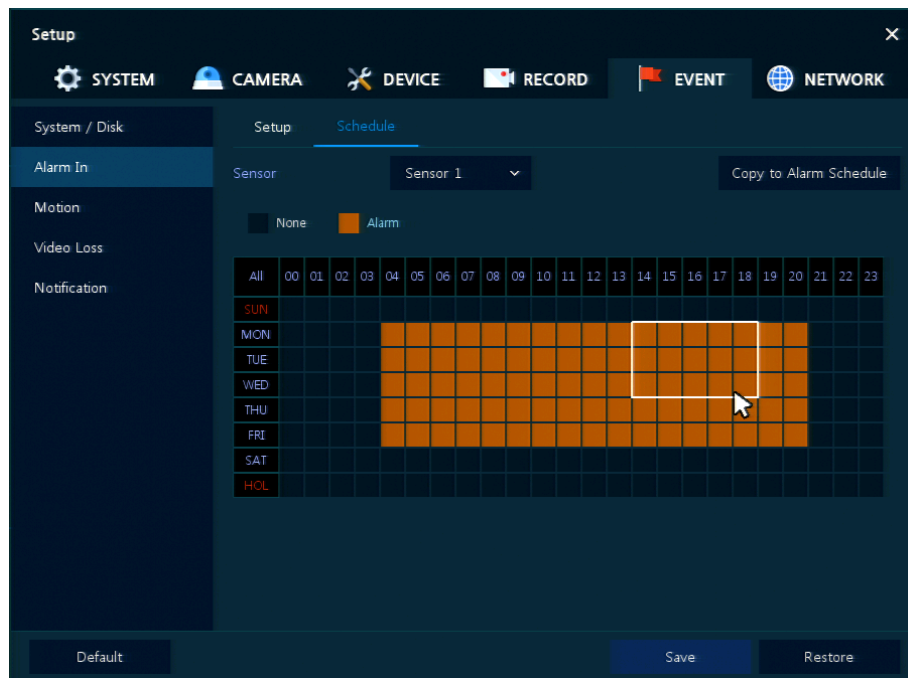

Figure 4-36 Event > Alarm In > Schedule

Table 4-38 Event > Alarm In > Schedule Item and Description

No.	Name	Function
1	Sensor	Select the sensor to set the schedule.
2	Schedule Type Selection	Select the types of schedules.
3	Schedule Table	Display the schedule users set.
4	Drag Field	Display the area dragged with a mouse.
5	Copy to Alarm Schedule	Copy the schedule on alarm set to other sensors. For more information about set value copy, see section "4.5.2 Stream > Main Stream in Stream."

**Note** For more details about scheduling recording time when alarm occurs across sensors, see section "4.5.1 Schedule > Schedule."

### 4.6.3 Motion

To set and schedule motions across channels

#### Motion > Setup

To set motions across channels

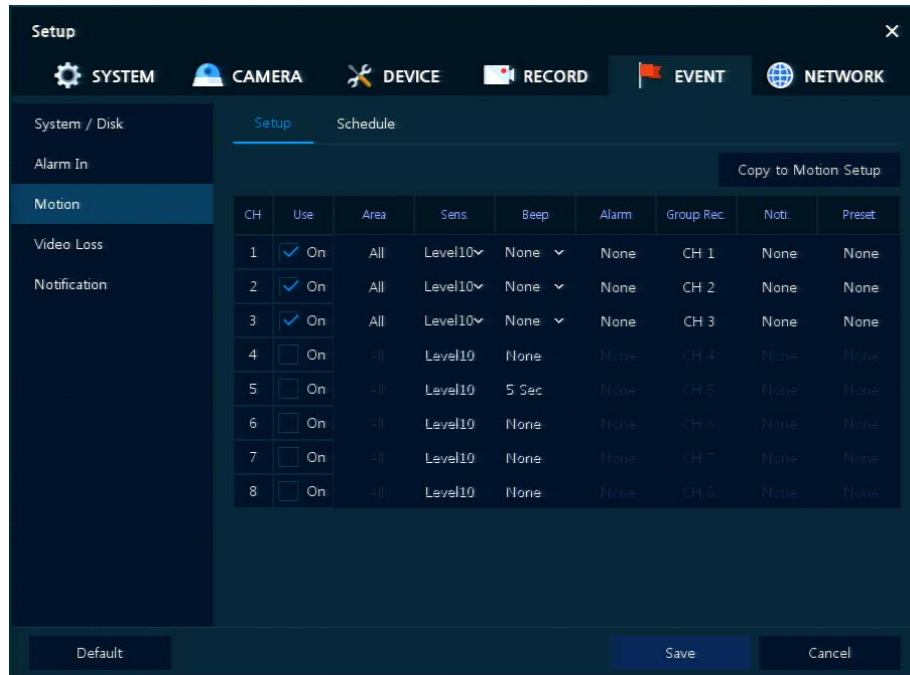



Figure 4-37 Event > Motion > Setup

Table 4-39 Event > Motion > Setup Item and Description

No.	Name	Function
1	CH	Display channels.
2	Use	Select/deselect whether to use motion function in the channel.
3	Area	Display the motion area.
4	Sens.	Select the sense level of the motion sensor (Level 1~10).
5	Beep	Select use time of buzzer (null, 5 sec, 10 sec, 20 sec, 30 sec, 1 min, 10 min, 30 min, and 1 hour).
6	Alarm	Set alarm output.
7	Group Rec.	Select the camera to record simultaneously.
8	Noti.	Set email notices.
9	Preset	Set preset of PTZ camera.
10	Copy to Motion Setup	Copy motion set value to other channels. For more information about set value copy, see section "4.5.2 Stream > Main Stream in Stream."

**Note** Placing your mouse on **Alarm**, **Group Rec**, **Noti.**, **Preset** and clicking editing icon  in right corner displays Event: Alarm screen. For more information about **Event: Motion** screen, see section "4.6.2 Alarm In > Setup in Alarm In."

## Motion > Schedule

To schedule record time when the motion sensor detects across channels

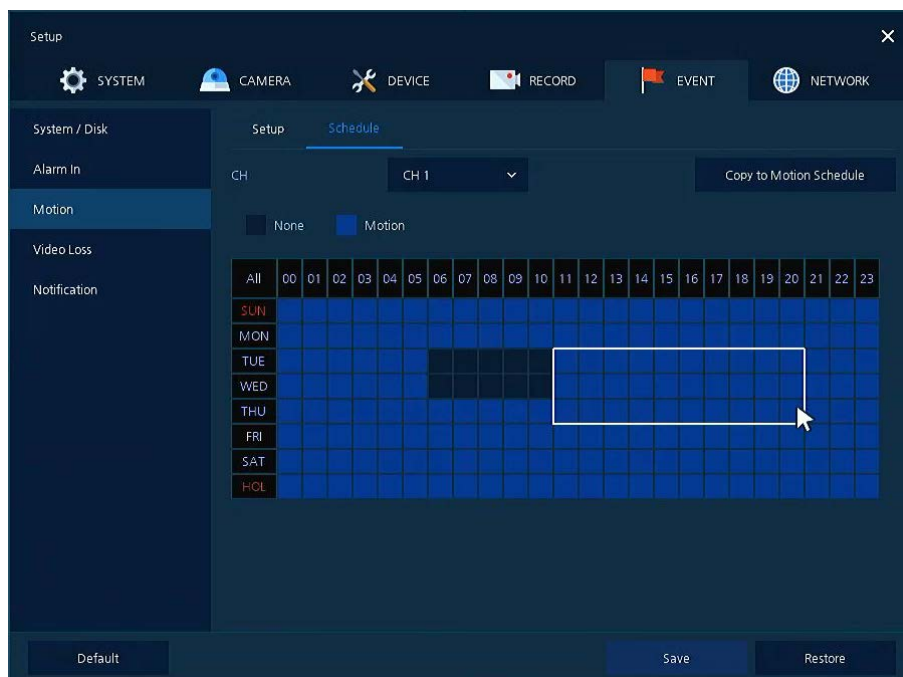

Figure 4-38 Event > Motion > Schedule

Table 4-40 Event > Motion > Schedule Item and Description

No.	Name	Function
1	CH	Select channels to set schedules.
2	Schedule Type Selection	Select the types of schedules.
3	Schedule Table	Display the schedule users set.
4	Drag Field	Display the area dragged with a mouse.
5	Copy to Motion Schedule	Copy the motion detection schedule to other channels. For more information about set value copy, see section "4.5.2 Stream > Main Stream in Stream."

**Note** For more information how to schedule record time when the motion sensor detects across channels, see section "4.5.1 Schedule > Schedule."

## 4.6.4 Video Loss > Setup

To set Video Loss across channels

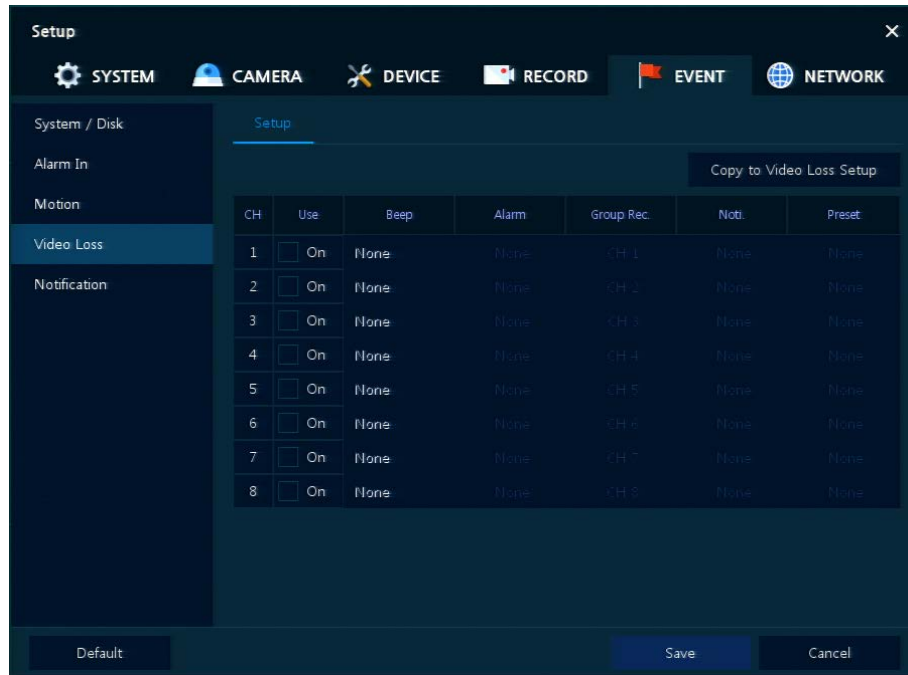



Figure 4-39 Event > Video Loss > Setup

Table 4-41 Event > Video Loss > Setup Item and Description

No.	Name	Function
1	CH	Display channels.
2	Use	Select/deselect whether to use Video Loss in the channel.
3	Beep	Select use time of buzzer sound (null, 5 sec, 10 sec, 20 sec, 30 sec, 1 min, 10 min, 30 min, and 1 hour).
4	Alarm	Set alarm output.
5	Group Rec.	Select the camera to record simultaneously.
6	Noti.	Set email notices.
7	Preset	Set preset of PTZ camera.
8	Copy to Video Loss Setup	Copy the Video Loss set value to other channels. For more information about set value copy, see section "4.5.2 Stream > Main Stream in Stream."

**Note** Placing your mouse on **Alarm**, **Group Rec**, **Noti.**, **Preset** and clicking editing icon  in right corner displays **Event: Video Loss** screen. For more information about **Event: Video Loss** screen, see section "4.6.2 Alarm In > Setup in Alarm In."

## 4.6.5 Notification

To set and schedule periodical alarms

Notification > Periodic

To set periodical alarms

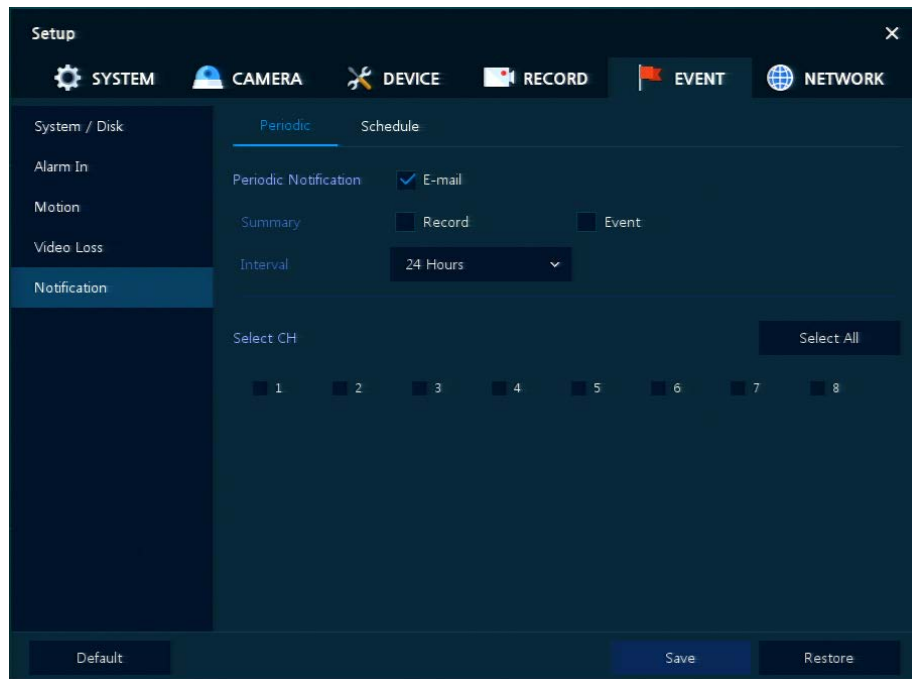

Figure 4-40 EVENT > Notification > Periodic

Table 4-42 EVENT > Notification > Periodic Item and Description

No.	Name	Function
1	Periodic Notification	Select/deselect whether to use periodical alarms
2	Summary	Send the save or event information. <ul style="list-style-type: none"> <li>▪ Record: sending the save information</li> <li>▪ Event: sending the event information</li> </ul>
3	Interval	Set the alarm interval (5 min, 10 min, 30 min, and 1 hour, 2-hour, 6-hour, 8-hour, 12-hour, and 24-hour).
4	Select CH	Select channels users want.
5	Select All /Unselect All	Select/deselect all channels

## Notification > Schedule

To schedule periodical alarms

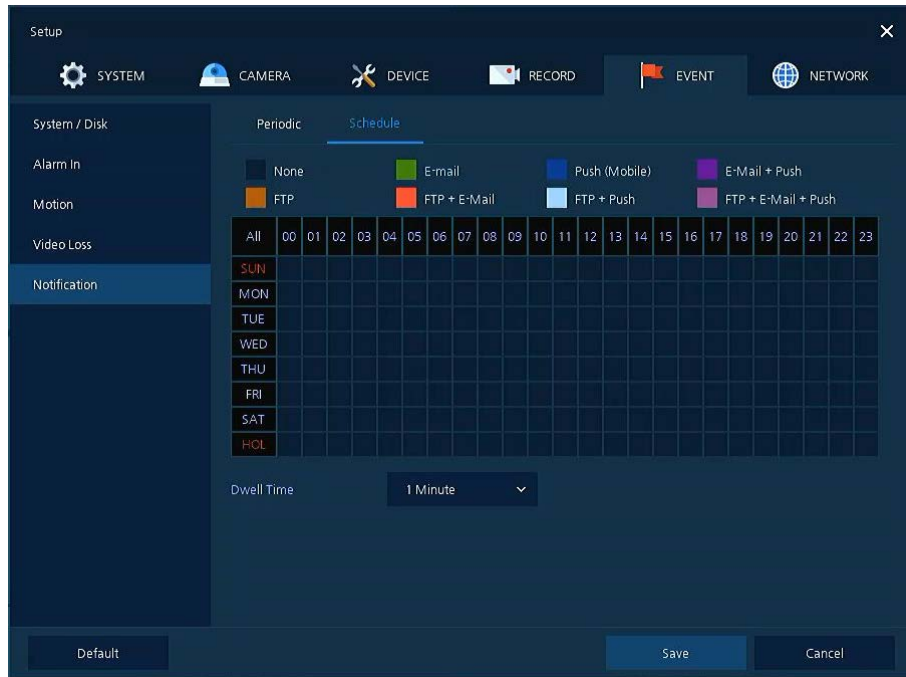

Figure 4-41 EVENT > Notification > Schedule

Table 4-43 EVENT > Notification > Schedule Item and Description

No.	Name	Function
1	Notification Type Selection	Select the types of notification. (None, E-mail, Push(Mobile), E-mail+Push, FTP, FTP+E-mail, FTP+Push, FTP+E-mail+Push)
2	Schedule Table	Display the schedule users set.
3	Drag Field	Display the area dragged with a mouse.
4	Dwell Time	Set Notification dwell time (1Min~1Hour).

**Note** For more information how to schedule record time when the alarm is detected, see section "4.5.1 Schedule > Schedule."

## 4.7 NETWORK

In **NETWORK**, users may set the network environment.

### 4.7.1 Basic

#### Basic > WAN Port

To set the network WAN port

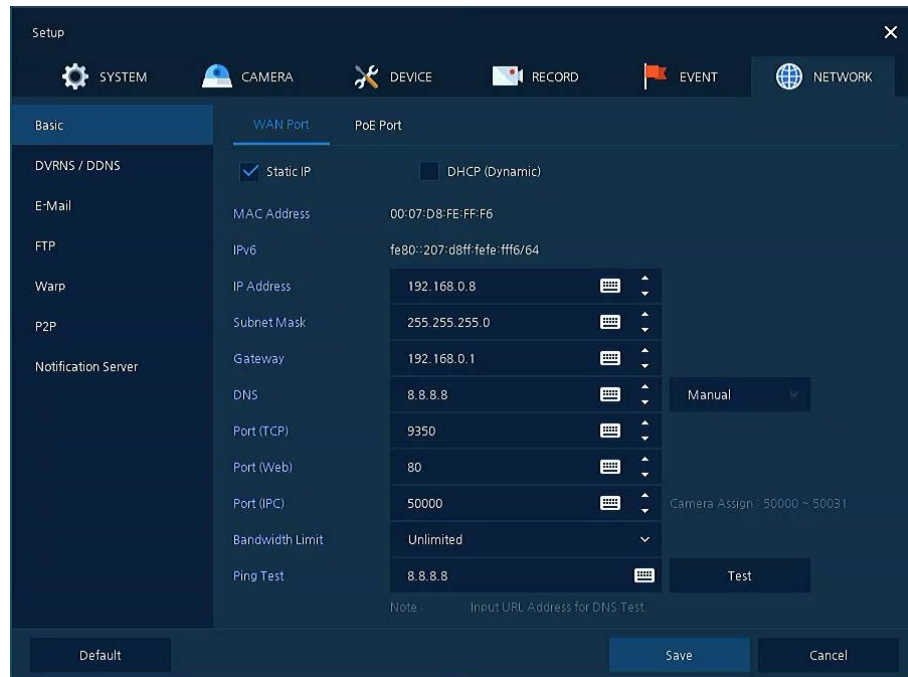

Figure 4-42 NETWORK > Basic > WAN Port

Table 4-44 NETWORK > Basic > WAN Port Item and Description

No.	Name	Function
1	Static IP	Check if you use static IP. For using static IP, enter IP address, Subnet Mask, and Gateway.
2	DHCP (Dynamic)	Select whether to use DHCP (Dynamic).
3	MAC Address	Display the MAC Address.
4	DNS	Select manual and enter DNS; otherwise choose automatic function.
5	Port (TCP)	Enter TCP port. Default is 9350.
6	Port (Web)	Enter Web port. Default is 80.
7	Port(IPC)	User can access camera directly using IPC port. Default is 5000.
8	Bandwidth Limit	Select bandwidth to limit (no limits, 50Mbps, 10Mbps, 5Mbps, 2Mbps, 1Mbps, 500Kbps, 400Kbps, 300Kbps, 200Kbps, and 100Kbps).
9	Ping Test	Enter IP in Ping test and implement the text.

## Basic > PoE Ports

To set the network PoE Ports

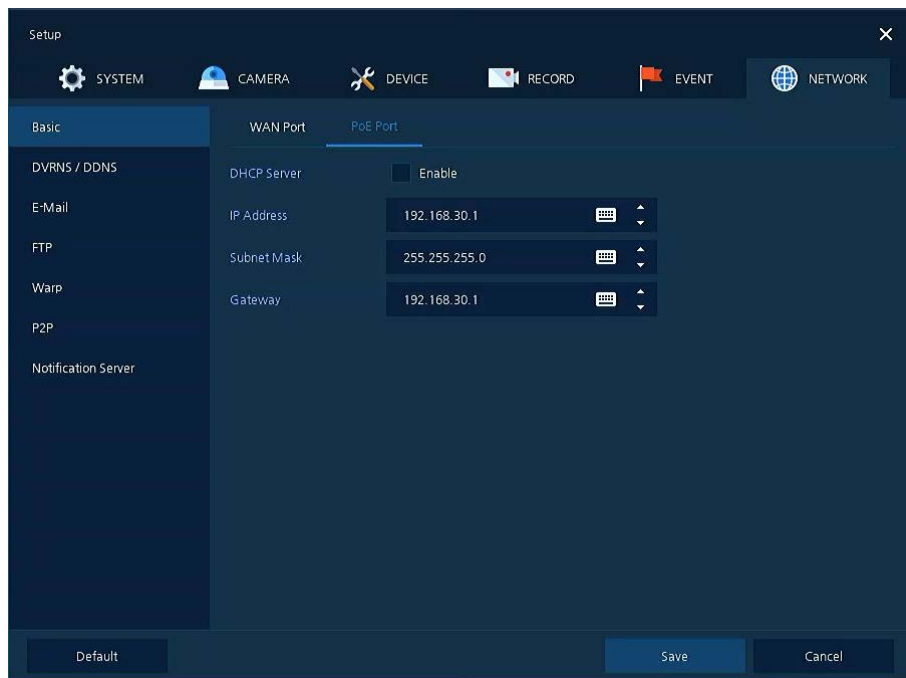

Figure 4-43 NETWORK > Basic > PoE Ports

Table 4-45 NETWORK > Basic > PoE Ports Item and Description

No.	Name	Function
1	DHCP Server	Select whether to enable DHCP server.
2	DHCP (Dynamic)	Select whether to use DHCP (Dynamic).
3	IP Address Subnet Mask Gateway	Enter the each information properly.



## 4.7.2 DVRNS/DDNS

To set DVRNS/DDNS

DVRNS/DDNS > DVRNS/Dashboard

To register DVRNS/Dashboard account

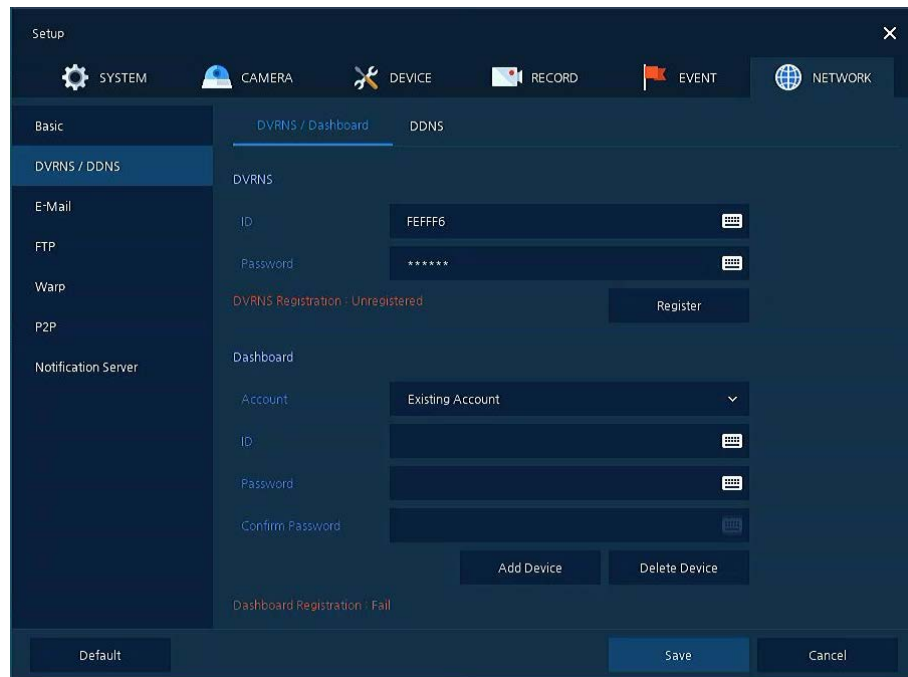

Figure 4-44 NETWORK > DVRNS/DDNS > DVRNS/Dashboard

Table 4-46 NETWORK > DVRNS/DDNS > DVRNS/Dashboard Item and Description

No.	Name	Function
1	DVRNS	Register DVRNS account <ul style="list-style-type: none"> <li>▪ ID: Enter DVRNS ID (default: MAC address of the unit)</li> <li>▪ Password: Enter DVRNS password</li> <li>▪ Register: Register DVRNS account</li> </ul>
2	Dashboard	Add/delete Dashboard account <ul style="list-style-type: none"> <li>▪ Account: Select the types of account (Existing Account or New Account)</li> <li>▪ ID: Enter Dashboard ID</li> <li>▪ Password: Enter Dashboard password</li> <li>▪ Add Device: Add Dashboard account</li> <li>▪ Delete Device: Delete Dashboard account</li> </ul>

## DVRNS/DDNS > DDNS

To set DDNS site for remote users to access in networking

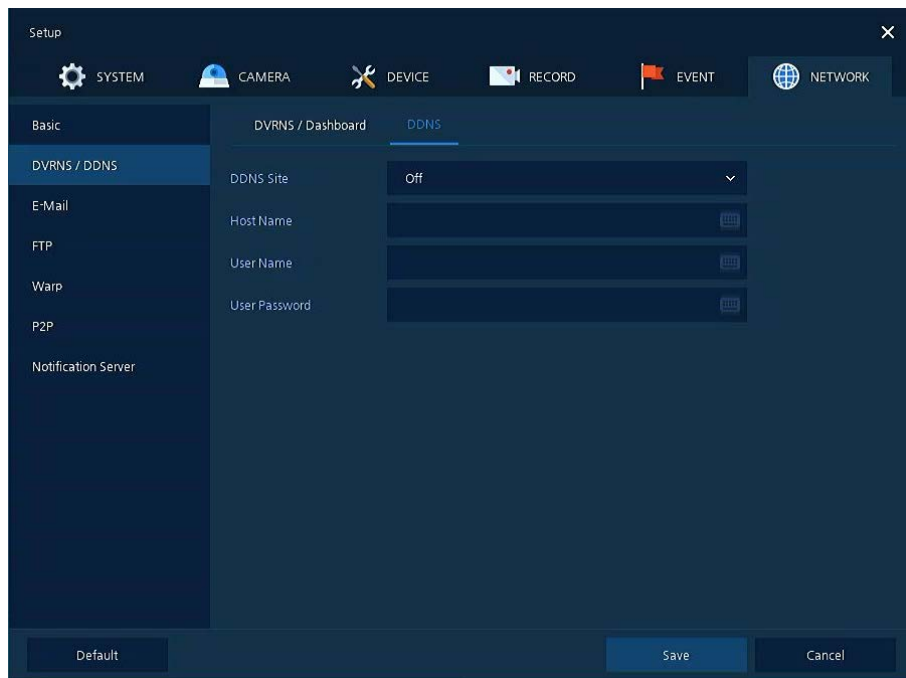

Figure 4-45 NETWORK > DVRNS/DDNS > DDNS

Table 4-47 NETWORK > DVRNS/DDNS > DDNS Item and Description

No.	Name	Function
1	DDNS Site	Select DDNS site
2	Host Name	Enter the host name.
3	User Name	Enter the user name.
4	User Password	Enter the user password.

### 4.7.3 E-Mail

To set email server to send email on the occasion of event

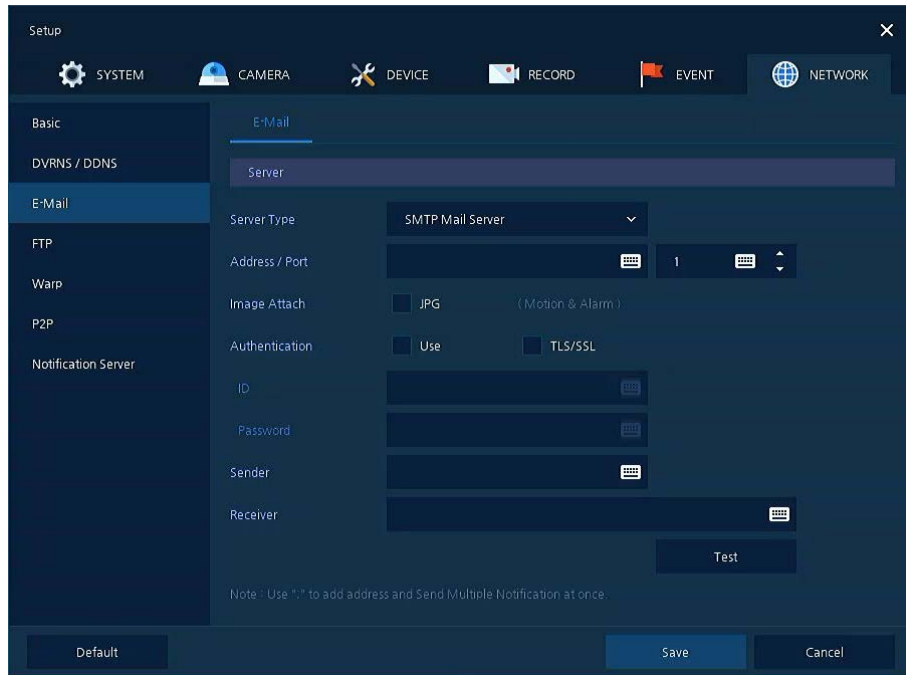

Figure 4-46 NETWORK > E-Mail > E-Mail

Table 4-48 NETWORK > E-Mail > E-Mail Item and Description

No.	Name	Function
1	Server Type	Select SMTP server. <ul style="list-style-type: none"> <li>▪ gmail.com</li> <li>▪ hotmail.com</li> <li>▪ aol.com</li> <li>▪ naver.com</li> <li>▪ daum.com</li> </ul>
2	Address/Port	Enter server address and port number.
3	Image Attach	Select/deselect whether to attach JPG image.
4	Authentication	Select/deselect using authentication and password.
5	ID	Enter the email ID.
6	Password	Enter the email password.
7	Sender	Write the sender.
8	Receiver	Write the receiver.
9	Test	Verify whether the email server is set normally.

## 4.7.4 FTP

Setup FTP server to send video to FTP server. The file format is AVI file.

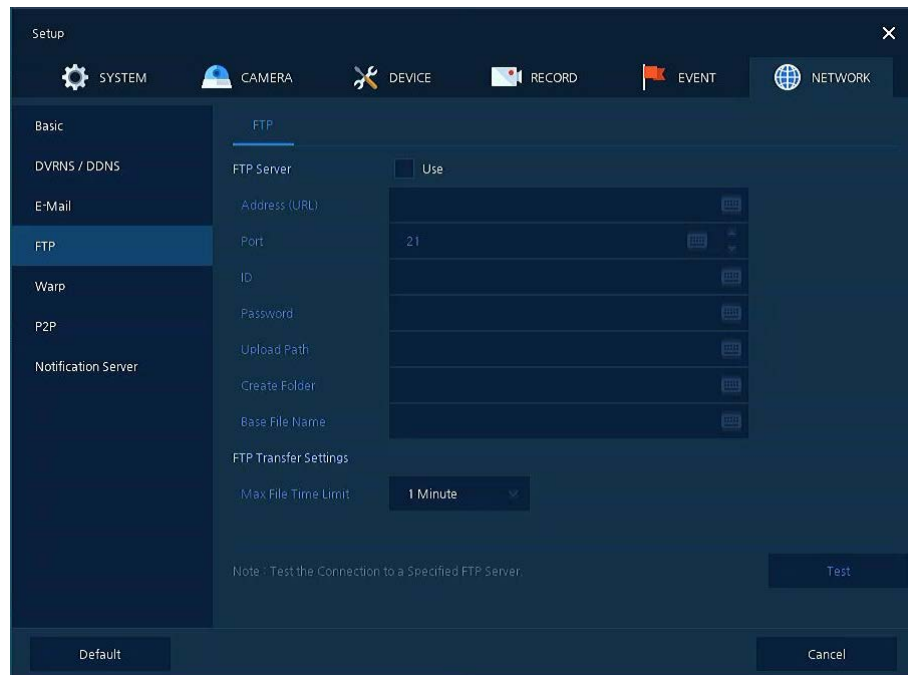

Figure 4-47 NETWORK > FTP > FTP

Table 4-49 NETWORK > FTP > FTP

No.	Name	Function
1	FTP Server	Select whether to use FTP.
2	Address(URL)/Port	Enter server address and port.
3	ID, Password	Enter ID & Password of server.
4	Upload Path	Enter upload directory.
5	Create Folder	Enter desired folder name.
6	Base File Name	Enter desired file name.
7	FTP Transfer Settings	Select max file time (1, 5, 10, 15minutes).
8	Test	Verify whether the FTP server is set normally.

## 4.7.5 Warp

Register the recorder to monitor and control remotely.

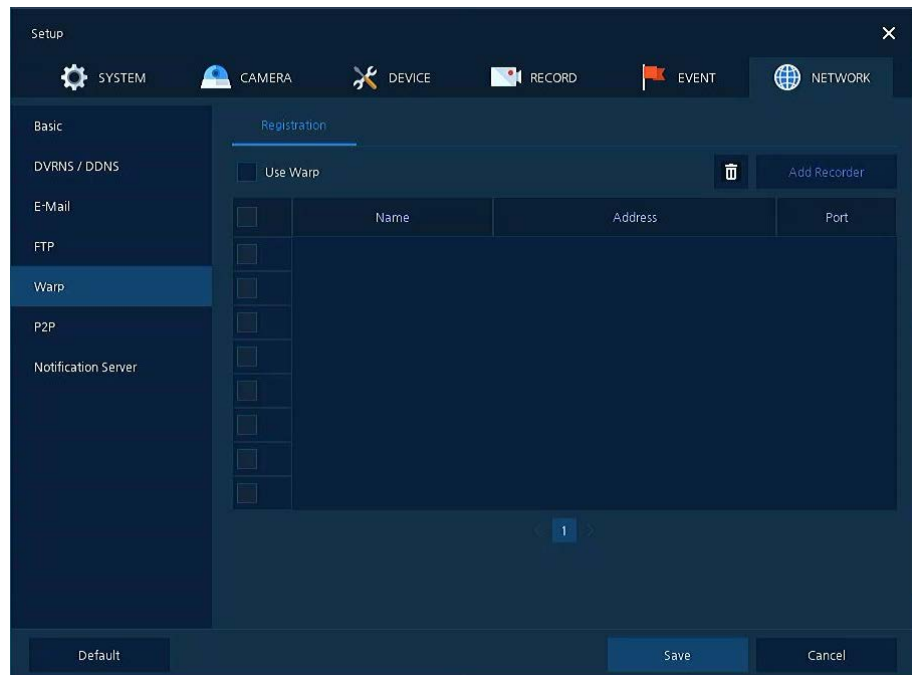



Figure 4-48 NETWORK > Warp > Registration

Table 4-50 NETWORK > Warp > Registration

No.	Name	Function
1	Use Warp	Select whether to enable Warp.
2		Delete registered recorder.
3	Add Recorder	Register the recorder to monitor and control.

## 4.7.6 P2P

User can connect recorder from mobile app using QR code scan.

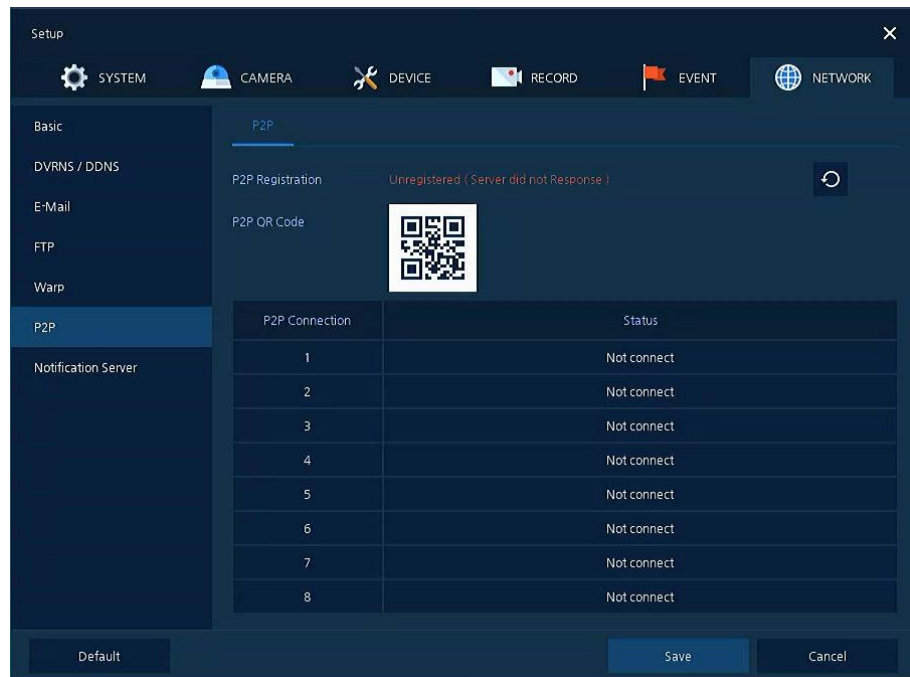



Figure 4-49 NETWORK > P2P > P2P

Table 4-51 NETWORK > P2P > P2P

No.	Name	Function
1	P2P Registration	Click  button to check up registration status.
2	P2P QR Code	Scan QR code using mobile app to connect recorder.
3	P2P Connection	Display connection status.

## 4.7.7 Notification Server

Notification Server > Notification Server

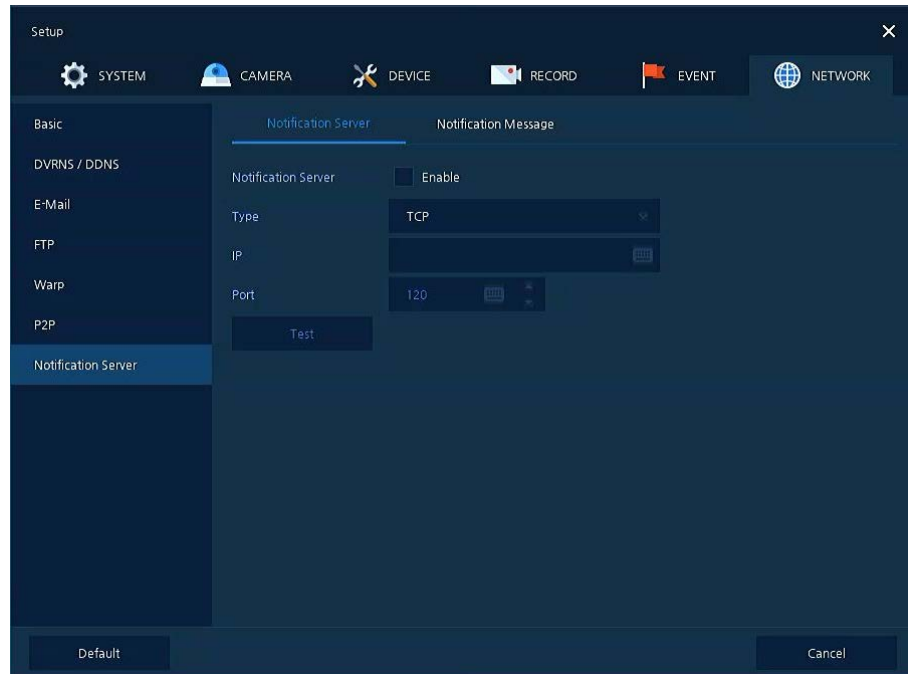
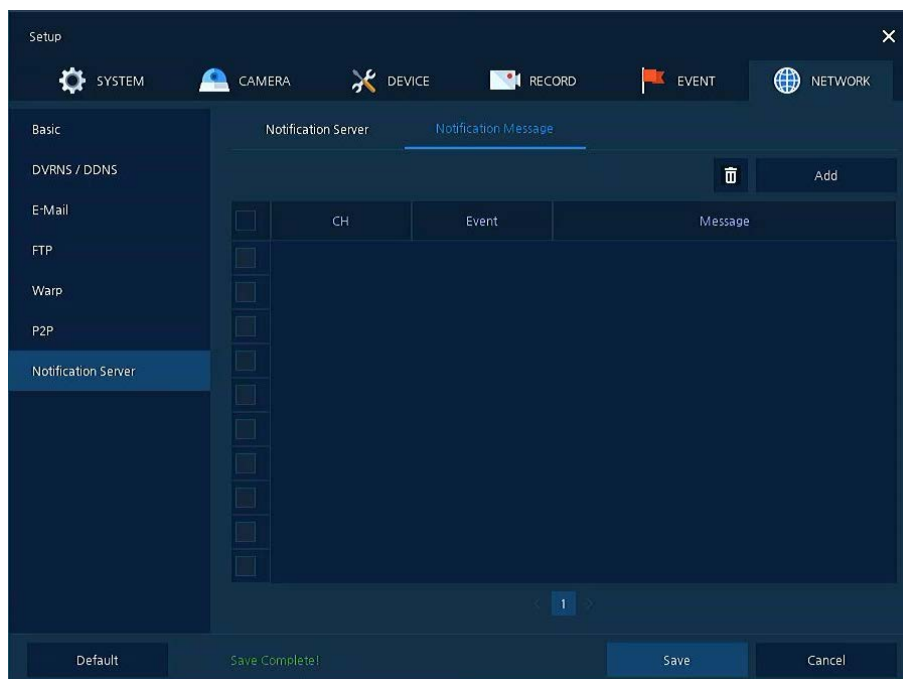

**Figure 4-50 NETWORK > Notification Server > Notification Server**

**Table 4-52 NETWORK > Notification Server > Notification Server**

No.	Name	Function
1	Notification Server	Check Enable to use Notification function.
2	Type	Select protocol type (TCP/UDP).
3	IP/Port	Enter server address and port.

## Notification Server > Notification Message



**Figure 4-51 NETWORK > Notification Server > Notification Message**

**Table 4-53 NETWORK > Notification Server > Notification Message**

No.	Name	Function
1		Deleted registered notification message.
2	Add	Notification message edit window pop-up.
3	CH	Camera channel.
4	Event	Display event type as Motion, Alarm, Video Loss.
5	Message	Display notification message.





## 5. Search/Play

This chapter describes Live Launcher search and play menu in the below screen bar.



Figure 5-1 Live Launcher Search, Play menu

Table 5-1 Item and Description of Live Launcher Search, Play menu

No.	Item	Description
1		Search recording data (time, event, thumbnail, smart search, text and VCA).
2		Playback recorded data

### 5.1 Search

This function searches recorded data as Time, Event, Thumbnail, Smart Search, Text and VCA.

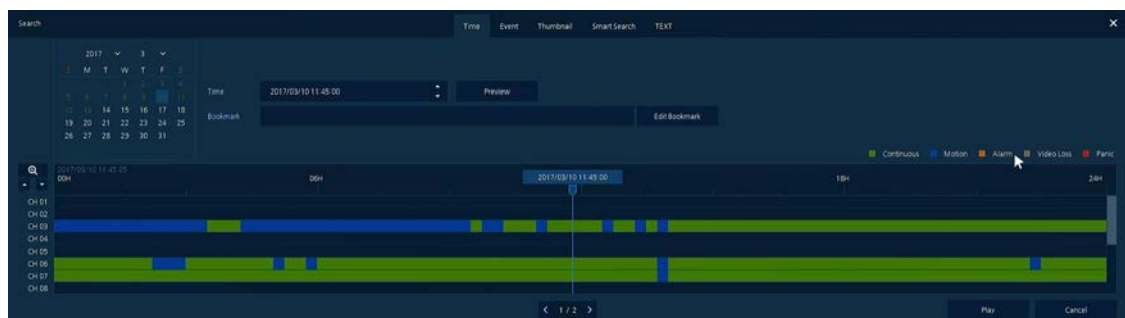

Figure 5-2 Search: Time

Table 5-2 Search: Time Item and Description

No.	Item	Description
1	Calendar	Selecting the date to search
2	Time	Setting time to search
3	Bookmark	Selecting a bookmark to search
4	Timeline	Display timelines across channels
5	Preview	Previewing video clips searched
6	Play	Playing video clips. For more information about Live bar, see section "5.2 Playback."
7	Cancel	Ending search screen

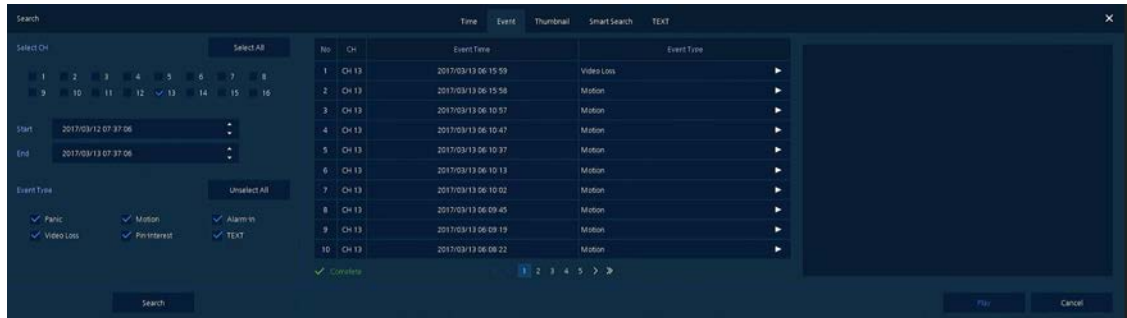

Figure 5-3 Search: Event

Table 5-3 Search: Event Item and Description

No.	Item	Description
1	Select CH	Select channels to search
2	Select All /Unselect All	Select/deselect all channels.
3	Start	Setting starting time to search
4	End	Setting ending time to search
5	EVENT TYPE	Selecting the types of event (immediate recording, motion, Alarm-In, Video Loss, and bookmark).
6	Search	Searching the event
7	Event List	Displaying event list searched
8	Thumbnail Field	Displaying thumbnail images of selected event
9	Play	Playing video clips selected. For more information about Live bar, see section "5.2 Playback."
10	Cancel	Ending search screen

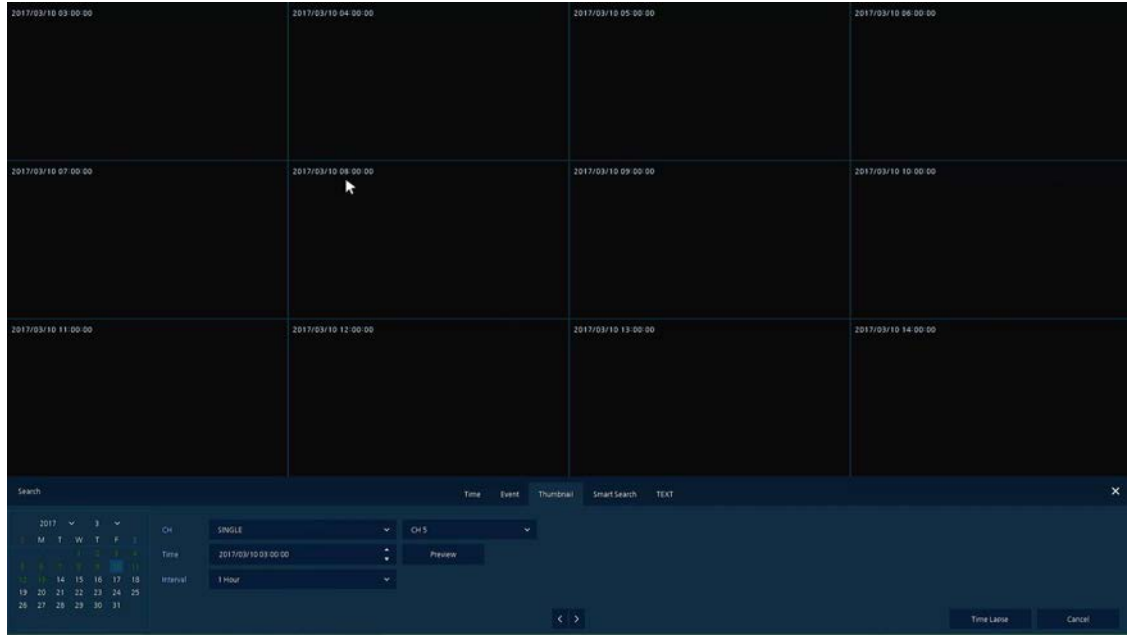

Figure 5-4 Search: Thumbnail

Table 5-4 Search: Thumbnail Item and Description

No.	Item	Description
1	Calendar	Selecting dates to search
2	CH	Selecting channels to search
3	Time	Selecting time to search
4	Interval	Setting time interval for searching images
5	Time Lapse/Pause	Playing or stopping videos searched
10	Cancel	Ending search screen

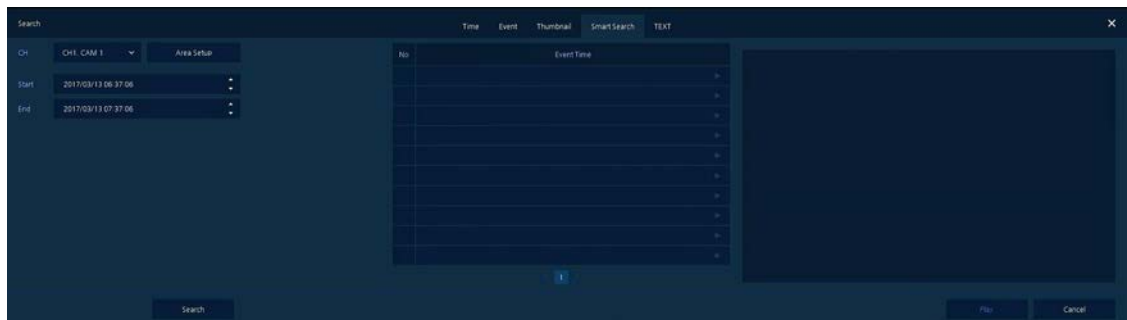

Figure 5-5 Search: Smart Search

Table 5-5 Search: Smart Search Item and Description

No.	Item	Description
1	CH	Selecting channels to search.
2	Area Setup	Select area to search motion event.

No.	Item	Description
3	Start	Setting starting time to search.
4	End	Setting ending time to search.

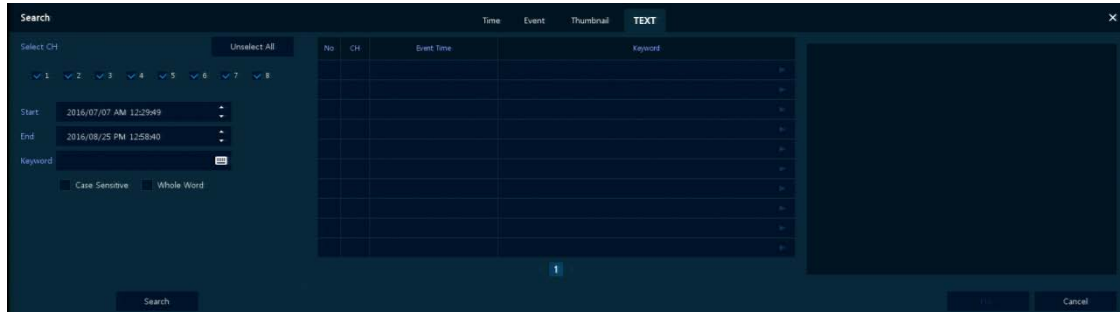

Figure 5-6 Search: Text

Table 5-6 Search: Text Item and Description

No.	Item	Description
1	Select CH	Select channels to search
2	Select All /Unselect All	Select/deselect all channels.
3	Start	Setting starting time to search
4	End	Setting ending time to search
5	Keyword	Entering keyword to search
6	Case Sensitive	Searching items in case-sensitive
7	Whole Word	Searching items that include all words
8	Search	Searching the event
9	Event List	Displaying event list searched
10	Thumbnail Field	Displaying thumbnail images of selected event
11	Play	Playing video clips selected. For more information about Live bar, see section "5.2 Playback."
12	Cancel	Ending search screen

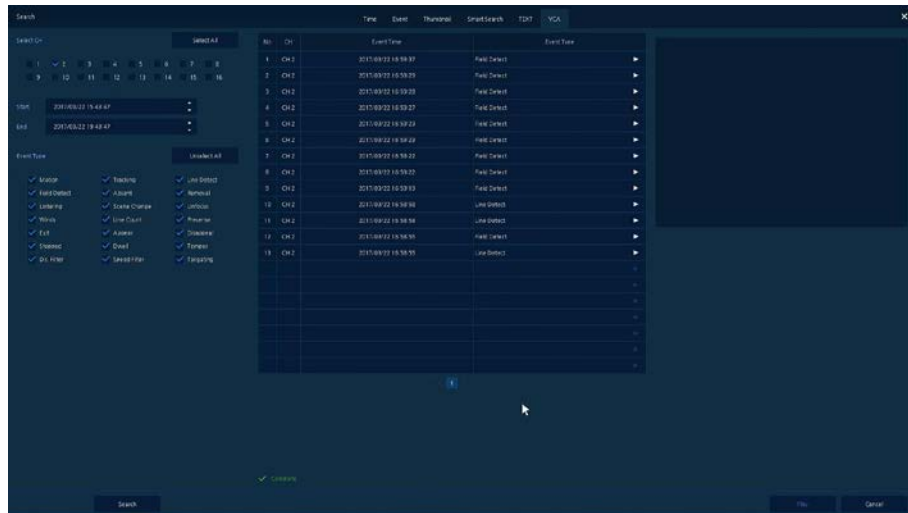

Figure 5-7 Search: VCA

Table 5-7 Search: VCA Item and Description

No.	Item	Description
1	Select CH	Selecting channels to search
2	Start, End	Set start time and end time.
3	Event Type	Selecting VCA event type.
4	Search	Search VCA event.
5	Play	Playback selected event.

## 5.2 Playback

To play recorded data



Figure 5-8 Playback Launcher



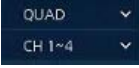

Table 5-8 Playback Launcher Item and Description

No.	Item	Description
1		Display present play status.
2	Date and Time	Display date and time of playing videos.
3		Go to first section of the video.
4		Play fast backward (2~64x).
5		Decrease speed under playback mode (1/2~1/8x), Backward step under pause mode
6		Play and pause the videos (toggle).
7		Play forward step.
8		Play fast forward (2~64x).
9		Playing the videos with multiplied speed forward (2~64x).
10		Moving to previous/next partition screens
11		Selecting the partition mode to mark in the screen
12		Searching the recorded data (time, event, thumbnail, smart search, text and VCA). For more information about search, see section "5.1 Search."
13		Closing playing videos and moving to live screen
14		Opening or closing the record timelines
15		Activating/deactivating automatic hidden function of Launcher menu

### 5.2.1 Record Time-Line



No.	Name	Function
1		Save bookmark.

No.	Name	Function
2		Open manual backup menu.
3		Open calendar.
4		Show time bar by single channel, 4channels or all channels.
5		Show time line by 1hour or 24hours (toggle).

## 5.2.2 Playback Quick menu

Click mouse right button to open quick menu in the playback mode.

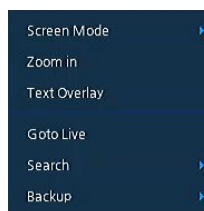

Figure 5-9 Playback Quick menu

Table 5-9 Playback Quick menu

No.	Item	Description
1	Screen Mode	Select the partition mode of live screen (Full, 2X2, 3X3, and 4x4).
2	Zoom in	Magnify selected live screen (2x, 4x 8x). This menu is shown full screen mode only.
3	Text Overlay	POS text overlay on the screen. This menu is shown when enable Text menu.
4	Goto Live	Stop playback and return to live mode.
5	Search	Open Search window.
6	Backup	Open manual backup menu.

## 6. Webviewer

This chapter describes webviewer for monitoring videos through a PC in remote mode.

How to monitor with webviewer

**Table 6-1 System Requirement for Webviewer**

Item	Recommended	Minimum
OS	Microsoft® Windows® 10 x86(64bit) (Home Premium, Professional, Ultimate) Microsoft® Windows® 8(pro, Enterprise)	Microsoft® Windows® XP Home SP3
CPU	Intel Core™ i5-2550 3.30GHz or higher	Intel Core™ 2 Duo E7200 2.53GHz or higher
RAM	2GB or higher	1.5GB or higher
VGA	ATI Radeon™ HD 3650 or NVIDIA GeForce 8400GS or higher(1280x1024, 32bpp or Higher), Multi Monitor	ATI Radeon™ HD 2400 or NVIDIA GeForce FX5500 or higher(1024x768, 24bpp or higher)
HDD	Over 6GB	Over 1GB
LAN	Gigabit Ethernet	10/100 Mbps Ethernet

- 1 Enter IP address of a recorder in Internet browser.
- 2 Enter ID and Password, and then click the button.
  - Viewer: playing NVR Live images
  - Setup: setting menu in similar ways with NVR connected monitor.

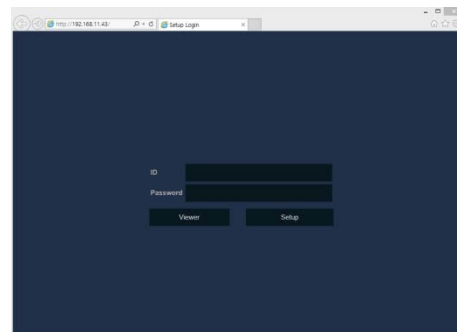

For using Viewer, users need to download Java. The way to download is shown as follows:

In case of selecting Viewer (Internet Explorer)



1 Click **Viewer**.

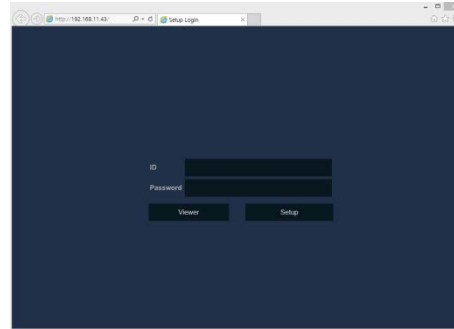

2 When Java download screen opens, download and install JAVA.

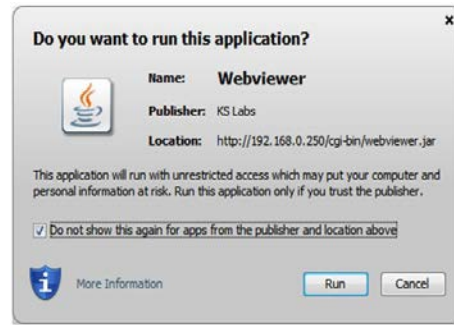

3 Live images may be monitored.

In case of selecting Viewer (Chrome)

1 After click **Viewer**, .jnp file can be downloaded.  
Click **Keep** button.

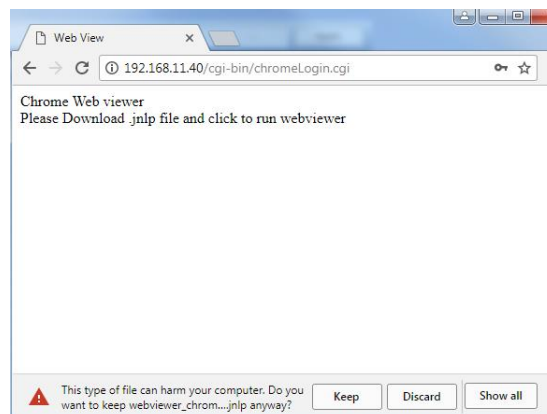

2 Click **webviewer\_chrome.jnlp**.

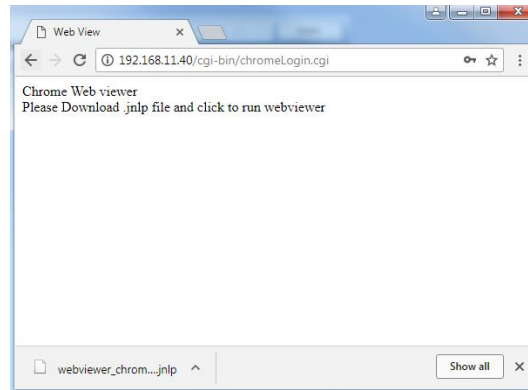

3 When Java download screen opens, download and install JAVA.

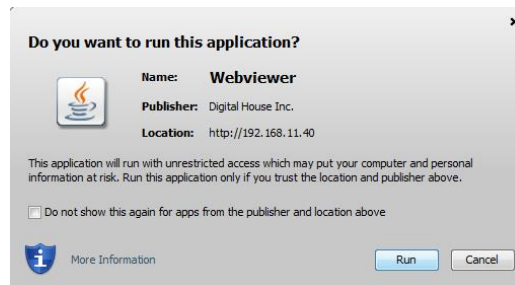

4 Live images may be monitored.

### In case of selecting Setup

Users can set the menu in similar ways with NVR connected monitor.

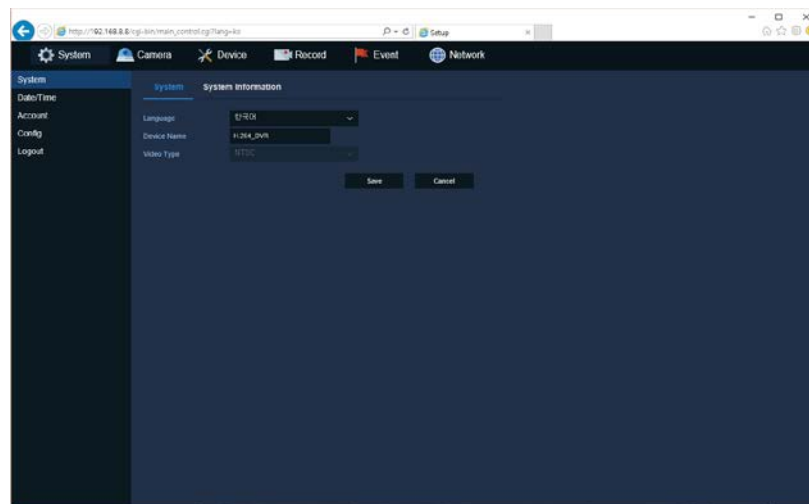

Figure 6-1 Setup screen

# 7. Appendix

## 7.1 Installing System Keyboard

To setup the keyboard controllers, the user needs to setup the network, passwords and perform special tasks such as Uploading and Downloading programmed data from the dome cameras. To enter the Keyboard menu, press and hold CTRL and press MENU expressed as CTRL + MENU in the manual. You will see the following menu.

Keyboard Setup- for USB

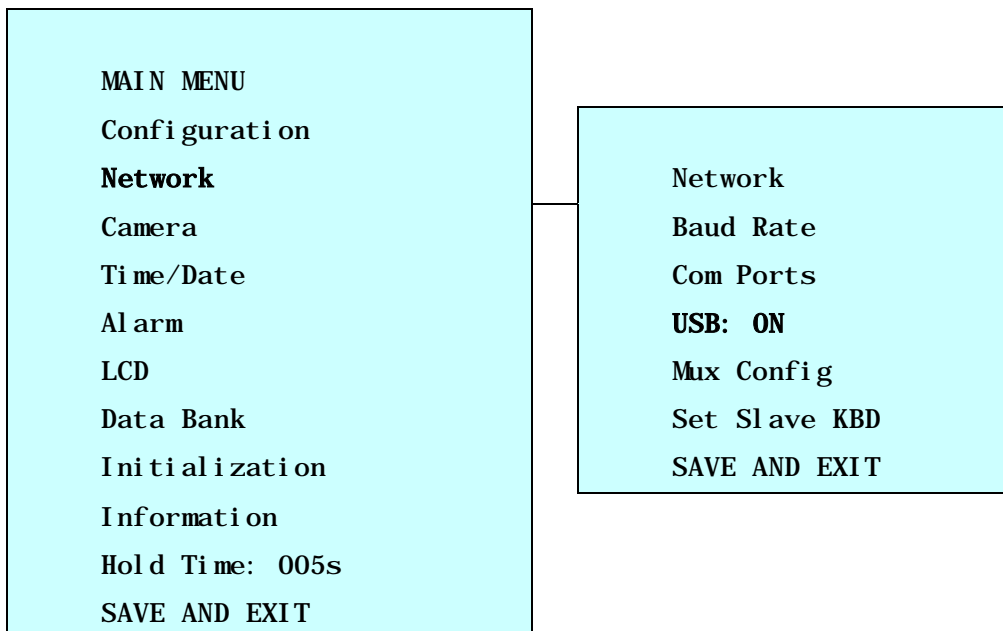
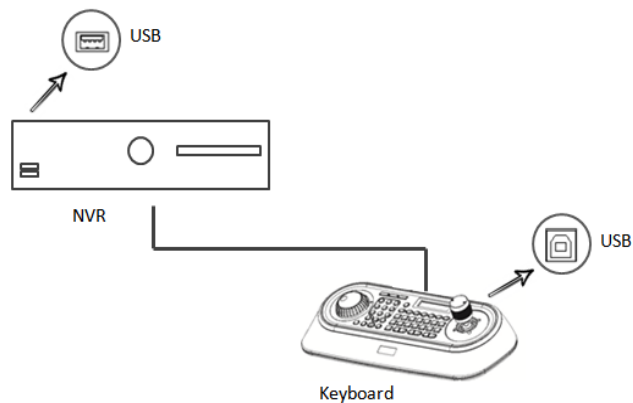

Set USB On in the keyboard menu.

Menu	Status	Configuration
USB	ON	Client Keyboard : Only USB Port(The other ports and slave keyboards are not supported)
	OFF	General Keyboard : Dome1/Dome2/RS232(The USB port is not supported)

**Note**

If Keyboard Controller power is disconnected and reconnected, you must also disconnect and reconnect the USB either from the Keyboard Controller or DVR/NVR side

Keyboard Setup- for RS485

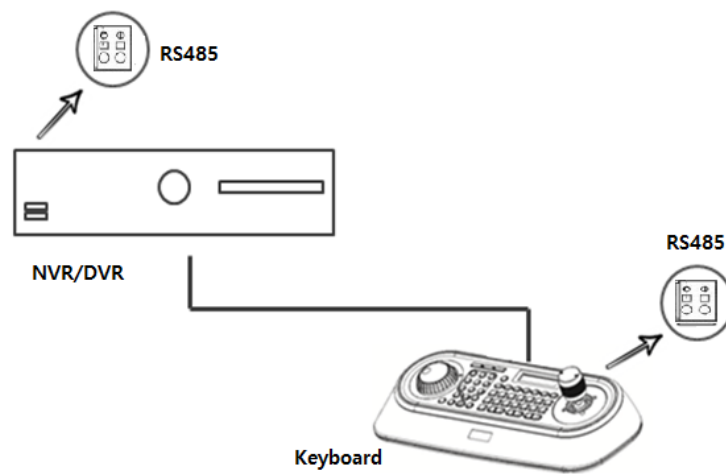

SET USB Off and Dome1: DVR5 in keyboard menu.

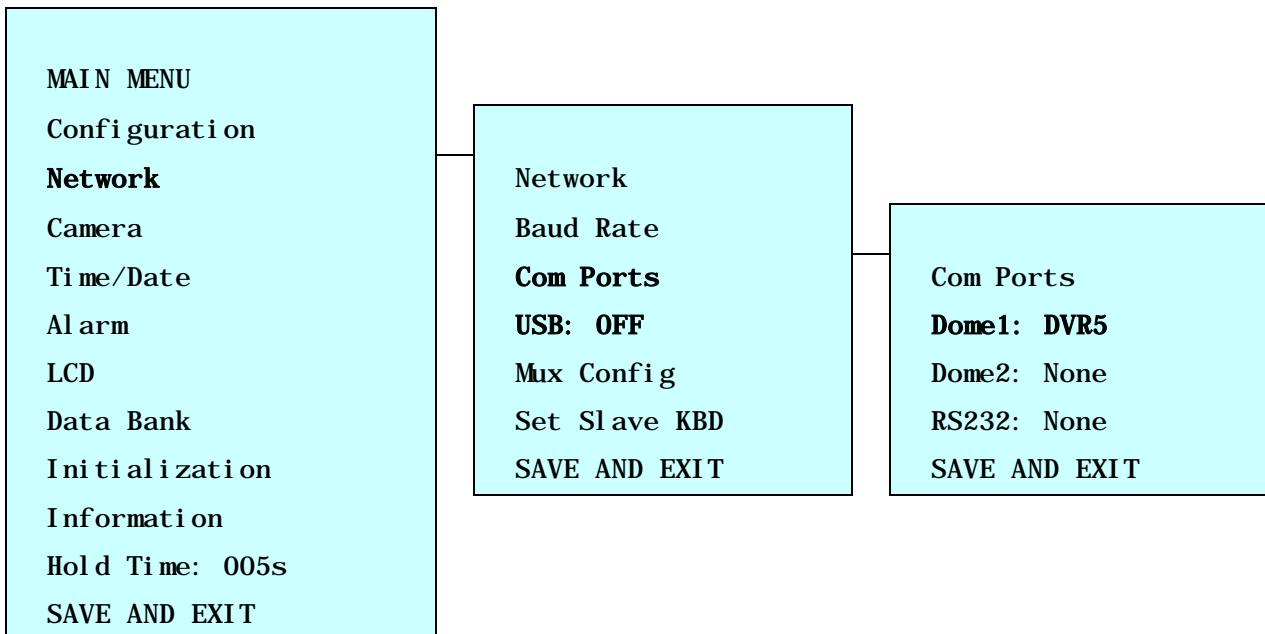

## Recorder Setup

Set serial port of recorder.

### Device > Serial Device

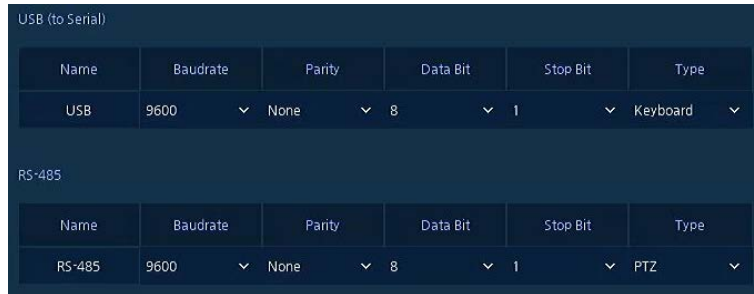

In case of USB Connection









Name	Baudrate	Parity	Data	Stop bit	Type
USB	9600	None	8	1	Keyboard

In case of RS-485 Connection





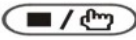



Name	Baudrate	Parity	Data	Stop bit	Type
RS-485	9600	None	8	1	Keyboard





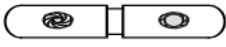
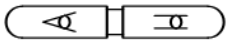

### KBD Controller Keys in Live mode

Function	Key Label	Descriptions
Menu		Enter the DVR/NVR MENU screen. Pressing the button also closes the MENU screen. Using the Joystick, you can navigate menu and select by turning the Joystick clockwise. This will also function as Enter.
Display Mode		Change the display mode to different split screen.
PTZ		Control PTZ camera(s) connected channel(show  icon). In the PTZ control mode, PTZ icon changes to . Please  to open PTZ quick menu. Press PTZ button again to exit PTZ mode.
Enter		Select a highlighted item or completes an entry that you have made. Using the Joystick and turning it clockwise will also function as Enter.
Full Screen and Input Number	No. +	Displays selected channel in full screen. However, when selecting a channel to display in full screen, no channels must be highlighted (yellow border) in the multi-channel mode.
Digital Zoom		From Live display, select the desired channel and press Zoom button to activate the Zoom Mode. Twist joystick to zoom in and out control.







		Press again to exit zoom mode.
Digital Zoom Control		Digital zoom in/out control.
Freeze		From Live Display, click the FRE button to activate the Freeze Mode.
Auto Sequence Mode		When in the Live Mode, press the SEQ button will display another full live channel sequentially.
Alarm		Will turn off the alarm and beep.
Record		Toggle will start and stop the panic recording operation.
Search		Open search menu. Press again, menu move to Time -> Event -> Thumbnail -> Smart Search -> Text -> VCA. Click cancel in the recorder menu or press  to exit search menu.
Play		Go to Playback mode. During playback, pause the video.
Joystick		<ul style="list-style-type: none"> <li>- The use of the Joystick will allow you select channels, view in different modes (single or multiple), Zoom in/out, Select/Enter or navigate through menu.</li> <li>- Turn the Joystick counter clockwise for single view mode.</li> </ul>

#### KBD Controller Keys in PTZ mode

Function	Key Label	Descriptions
PRESET, TOUR, PTRN, SCAN Action	No. +    	PRST, TOUR, PTRN, SCAN action
PRESET Setting	No. +  	Preset save.
Zoom		Zoom in/out control. Turn the Joystick clockwise or counter clockwise for zoom in/out control.
Iris		Iris Open/Close control, Smart focus(specific camera). Open camera OSD menu(specific camera)
Focus		Focus Near/Far control.
Configuration		Enters PTZ programming menu.

Control		CTRL + Joystick : In a programming mode (Preset, Pattern, Scan, Privacy...) the joystick operates as if in the normal control mode. While pressing and holding down the CTRL key, all movements of the joystick will start recording when in the pattern programming menu
Cancel		Cancels current inputs. Exits from currently running functions or menu, error status, etc.
Enter		Completes entering data for the password or title
PTZ		Enter or exit PTZ mode.
Menu	MACRO 	Open PTZ quick menu.
Enter	SET 	Enter button under quick menu or pop-up menu.
Channel Change	No. + 	Channel change.
Joystick		PTZ control or menu navigation control.

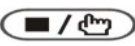
#### KBD Controller Keys in Playback mode

Function	Key Label	Descriptions
Play Back Control		Play/Pause recorded data
Play Back (PB) Stop	  	Pause/Play, Fast Forward, Fast Rewind, Forward One Frame, Go Back One Frame
Play Back (PB) Stop		Stop Playback and return to Live mode
Jog/Shuttle		Fast Forward, Fast Rewind, Forward One Frame, Go Back One Frame

## 7.2 Products Specification

Model	4Ch	8Ch	16Ch
<b>VIDEO</b>			
Video Input	4 IP	8 IP	16 IP
Video Input Resolution	Up to 5MP	Up to 5MPx4ch+3MPx4ch	Up to 5MPx4ch+3MPx12ch
Compression	H.264	H.264	H.264
Display Output	1 VGA, 1 HDMI	1 VGA, 1 HDMI	1 VGA, 1 HDMI
Display Resolution	1920x1080, 1280x720, 1024x768	1920x1080, 1280x720, 1024x768	1920x1080, 1280x720, 1024x768
Display Speed	100/120fps	200/240fps	400/480fps
Display Mode	1/4 Split, Sequence	1/4/9 Split, Sequence	1/4/9/16 Split, Sequence
<b>RECORDING</b>			
Recording Speed	100/120fps@5MP	100/120fps@5MP + 100/120fps@3MP	100/120fps@5MP + 300/360fps@3MP
Max. Recording Throughput	32Mbps	64Mbps	128Mbps
Recording Mode	Continuous, Motion, Alarm, C+M, C+A, M+A, C+M+A, Panic	Continuous, Motion, Alarm, C+M, C+A, M+A, C+M+A, Panic	Continuous, Motion, Alarm, C+M, C+A, M+A, C+M+A, Panic
Pre Alarm	1sec ~ 5sec	1sec ~ 5sec	1sec ~ 5sec
Post Alarm	5sec ~ 1 hour	5sec ~ 1 hour	5sec ~ 1 hour
<b>PLAYBACK</b>			
Simultaneous Playback	1/4 Split	1/4/9 Split	1/4/9/16 Split
Playback Mode	Backward, Forward 2x~64x	Backward, Forward 2x~64x	Backward, Forward 2x~64x
Search Mode	Time, Event, Thumbnail, Smart Search, Text, VCA	Time, Event, Thumbnail, Smart Search, Text, VCA	Time, Event, Thumbnail, Smart Search, Text, VCA
<b>STORAGE</b>			
Internal HDD	1 SATA Interface	2 SATA Interfaces	2 SATA Interfaces
External Storage	iSCSI	iSCSI	iSCSI
Backup	USB	USB	USB
Backup File Format	AVI, H4V, MP4	AVI, H4V, MP4	AVI, H4V, MP4
<b>FUNCTION</b>			



Text In		POS/ATM (VSSI-Pro, ASCII, Network, )	POS/ATM (VSSI-Pro, ASCII, Network, )	POS/ATM (VSSI-Pro, ASCII, Network, )
User Interface		Mouse, IR Remote Control, USB/RS485 Keyboard	Mouse, IR Remote Control, USB/RS485 Keyboard	Mouse, IR Remote Control, USB/RS485 Keyboard
<b>NETWORK</b>				
Ethernet	WAN	1 RJ45 10/100/1000 Base-T	1 RJ45 10/100/1000 Base- T	1 RJ45 10/100/1000 Base-T
	PoE	4 RJ45 10/100 Base-T	8 RJ45 10/100 Base-T	16 RJ45 10/100 Base-T
	PoE power	42W(IEEE802.3af compliance)	74W(IEEE802.3af compliance)	130W(IEEE802.3af compliance)
Max. Output Throughput		Unlimited (Guarantee 72Mbps, Support Bandwidth Control)	Unlimited (Guarantee 144Mbps, Support Bandwidth Control)	Unlimited (Guarantee 288Mbps, Support Bandwidth Control)
Remote Monitoring		CMS, Mobile, Web, Dashboard	CMS, Mobile, Web, Dashboard	CMS, Mobile, Web, Dashboard
<b>EXTERNAL IN/OUT</b>				
Audio In		4 IP Camera	8 IP Camera	16 IP Camera
Audio Out		1 RCA, 1 HD output	1 RCA, 1 HD output	1 RCA, 1 HD output
Alarm In		4 Input(Terminal block)	8 Input(Terminal block)	8 Input(Terminal block)
Alarm Out		1 Output(Terminal block)	1 Output(Terminal block)	1 Output(Terminal block)
Serial Interface		USB to Serial	USB to Serial	USB to Serial
USB		2 USB2.0, 1 USB3.0	2 USB2.0, 1 USB3.0	2 USB2.0, 1 USB3.0
<b>ETC</b>				
Operating Humidity		0 ~ 90% RH (Non- condensing)	0 ~ 90% RH (Non- condensing)	0 ~ 90% RH (Non-condensing)
Operating Temperature		0°C ~ +45°C	0°C ~ +45°C	0°C ~ +45°C
Power Supply		48VDC, 1.2A	48VDC, 2.0A	AC 110~220V, 3A
Power Consumption		14W(Include 1HDD, Without PoE)	20W(Include 2HDD, Without PoE)	20W(Include 2HDD, Without PoE)
Dimension(WxHxD)		300x47x209mm	378x47x317mm	378x47x317mm
Net Weight		Approx. 1Kg(Exclude HDD)	Approx. 2.5Kg(Exclude HDD)	Approx. 2.9Kg(Exclude HDD)

※ Specifications are subject to change without notice.



eneo® is a registered trademark of  
VIDEOR E. Hartig GmbH  
Exclusive distribution through special-  
ised trade channels only.

VIDEOR E. Hartig GmbH  
Carl-Zeiss-Straße 8  
63322 Rödermark/Germany  
Tel. +49 (0) 6074 / 888-0  
Fax +49 (0) 6074 / 888-100  
[www.videor.com](http://www.videor.com)  
[www.eneo-security.com](http://www.eneo-security.com)

Technical changes reserved

© Copyright by VIDEOR E. Hartig  
GmbH Version 12/2017