



Full Manual

**1/2.8" Network Dome, PoE,
1920x1080, ONVIF, Day&Night,
BLC, AWB, 3,5-16mm, Infrared**

NXD-980IR3516P B

WARNING

TO REDUCE THE RISK OF FIRE OR ELECTRIC SHOCK, DO NOT EXPOSE THIS PRODUCT TO RAIN OR MOISTURE. DO NOT INSERT ANY METALLIC OBJECT THROUGH THE VENTILATION GRILLS OR OTHER OPENINGS ON THE EQUIPMENT.

Apparatus shall not be exposed to dripping or splashing and that no objects filled with liquids, such as vases, shall be placed on the apparatus.

CAUTION

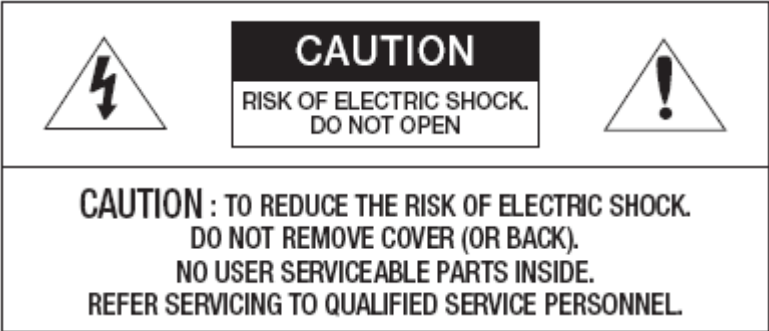

EXPLANATION OF GRAPHICAL SYMBOLS



The lightning flash with arrowhead symbol, within an equilateral triangle, is intended to alert the user to the presence of uninsulated "dangerous voltage" within the product's enclosure that may be of sufficient magnitude to constitute a risk of electric shock.



The exclamation point within an equilateral triangle is intended to alert the user to the presence of important operating and maintenance (servicing) instructions in the literature accompanying the appliance.

FCC COMPLIANCE STATEMENT

INFORMATION TO THE USER: THIS EQUIPMENT HAS BEEN TESTED AND FOUND TO COMPLY WITH THE LIMITS FOR A CLASS A DIGITAL DEVICE, PURSUANT TO PART 15 OF THE FCC RULES. THESE LIMITS ARE DESIGNED TO PROVIDE REASONABLE PROTECTION AGAINST HARMFUL INTERFERENCE WHEN THE EQUIPMENT IS OPERATED IN A COMMERCIAL ENVIRONMENT. THIS EQUIPMENT GENERATES, USES, AND CAN RADIATE RADIO FREQUENCY ENERGY AND IF NOT INSTALLED AND USED IN ACCORDANCE WITH THE INSTRUCTION MANUAL, MAY CAUSE HARMFUL INTERFERENCE TO RADIO COMMUNICATIONS.

CAUTION: CHANGES OR MODIFICATIONS NOT EXPRESSLY APPROVED BY THE PARTY RESPONSIBLE FOR COMPLIANCE COULD VOID THE USER'S AUTHORITY TO OPERATE THE EQUIPMENT.

THIS CLASS A DIGITAL APPARATUS COMPLIES WITH CANADIAN ICES-003.

CET APPAREIL NUMÉRIQUE DE LA CLASSE A EST CONFORME À LA NORME NMB-003 DU CANADA.

CE COMPLIANCE STATEMENT

WARNING: This is a Class A product. In a domestic environment this product may cause radio interference in which case the user may be required to take adequate measures.

CAUTION

RISK OF EXPLOSION IF BATTERY IS REPLACED BY AN INCORRECT TYPE.

DISPOSE OF USED BATTERIES ACCORDING TO THE INSTRUCTIONS

IMPORTANT SAFETY INSTRUCTIONS

1. Read these instructions.
2. Keep these instructions.
3. Heed all warnings.
4. Follow all instructions.
5. Do not use this apparatus near water.
6. Clean only with dry cloth.
7. Do not block any ventilation openings. Install in accordance with the manufacturer's instructions.
8. Do not install near any heat sources such as radiators, heat registers, stoves, or other apparatus (including amplifiers) that produce heat.
9. Do not defeat the safety purpose of the polarized or grounding-type plug. A polarized plug has two blades with one wider than the other. A grounding type plug has two blades and a third grounding prong. The wide blade or the third prong are provided for your safety. If the provided plug does not fit into your outlet, consult an electrician for replacement of the obsolete outlet.
10. Protect the power cord from being walked on or pinched particularly at plugs, convenience receptacles, and the point where they exit from the apparatus.
11. Only use attachments/accessories specified by the manufacturer.
12. Use only with the cart, stand, tripod, bracket, or table specified by the manufacturer, or sold with the apparatus. When a cart is used, use caution when moving the cart/apparatus combination to avoid injury from tip-over.
13. Unplug this apparatus during lightning storms or when unused for long periods of time.
14. Refer all servicing to qualified service personnel. Servicing is required when the apparatus has been damaged in any way, such as power-supply cord or plug is damaged, liquid has been spilled or objects have fallen into the apparatus, the apparatus has been exposed to rain or moisture, does not operate normally, or has been dropped.
15. **CAUTION – THESE SERVICING INSTRUCTIONS ARE FOR USE BY QUALIFIED SERVICE PERSONNEL ONLY. TO REDUCE THE RISK OF ELECTRIC SHOCK DO NOT PERFORM ANY SERVICING OTHER THAN THAT CONTAINED IN THE OPERATING INSTRUCTIONS UNLESS YOU QRE QUALIFIED TO DO SO.**
16. **Use satisfy clause 2.5 of IEC60950-1/UL60950-1 or Certified/Listed Class 2 power source only.**
17. ITE is to be connected only to PoE networks without routing to the outside plant.



Contents

1. Description	6
1.1 Components	6
1.2 Key Features	7
1.3 Layout	8
2. Installation	9
2.1 Camera Installation	9
2.2 Network Connection and IP Assignment	11
3. Operation	12
3.1 Access from a browser	12
3.2 Access from the internet	13
3.3 Setting the admin password over a secure connection	13
3.4 Live View Page	14
3.5 Network Camera Setup	16
3.5.1 Basic Configuration	16
1) Users	17
2) Network	18
3) Video & Image	19
4) Date & Time	21
3.5.2 Live View	22
3.5.3 Video & Image	23
3.5.4 Event	29
1) Event-In	29
1) Event-Out	34
2) Event Map	41
3.5.5 System	43
1) Information	43
2) Security	44
3) Date & Time	47
4) Network	48
5) Language	58
6) Maintenance	58
7) Support	59
3.5.6 About	62
3.6 Playback	62
3.7 Help	63
3.8 Resetting to the factory default settings	64
4. Appendix	65
4.1 Troubleshooting	65
4.2 Preventive Maintenance	66
4.3 Product Specification	67

1. Description

The Network Camera supports the network service for a sensor image with progressive scan, which can be monitored on a real-time screen regardless of distances and locations. By using its dedicated program, many users are able to have an access to the Network Camera at once or a single user can monitor various network cameras at the same time. It also enables users to play, store and retrieve a monitoring image by using a PC. All the settings and real-time monitoring screens are also provided through an access to the web.

The Network Camera is fully featured for security surveillance and remote monitoring needs. It is based on the DSP compression chip, and makes it available on the network as real-time, full frame rate Motion JPEG and H.264 (or MPEG-4) video streams.

1.1 Components

The system comes with the following components:



Camera



Installation CD

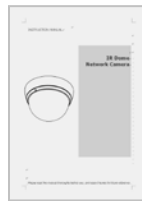

Installation Guide

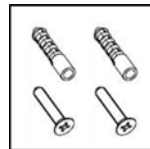

Accessory Kit

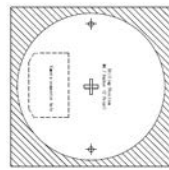

Grilling guide label

Notes:

1. Check your package to make sure that you received the complete system, including all components shown above.
2. Adapter for DC 12V is not supplied.

1.2 Key Features

- **Brilliant video quality**
The Network Camera offers the highly efficient H.264 video compression, which drastically reduces bandwidth and storage requirements without compromising image quality. Motion JPEG is also supported for increased flexibility.
- **Triple streams**
The Network Camera can deliver triple video streams simultaneously at full frame rate in all resolutions up to 1920 x 1080 using Motion JPEG and H.264 (or MPEG-4). This means that several video streams can be configured with different compression formats, resolutions and frame rates for different needs.
- **Image setting adjustment**
The Network Camera also enables users to adjust image settings such as contrast, brightness and saturation to improve images before encoding takes place.
- **Micro-SD Recording support**
The Network Camera also supports a micro-SD memory slot for local recording with removable storage.
- **Improved Security**
The Network Camera logs all user access, and lists currently connected users. Also, its full frame rate video can be provided over HTTPS.
- **Megapixel Resolution**
Max 30fps@1920x1080
- **PoE**
This network camera can be powered through PoE, which simplifies installation since only one cable is needed for carrying power, as well as video controls.
- **ONVIF**
This is a global interface standard that makes it easier for end users, integrators, consultants, and manufacturers to take advantage of the possibilities offered by network video technology. ONVIF enables interoperability between different vendor products, increased flexibility, reduced cost, and future-proof systems.

1.3 Layout

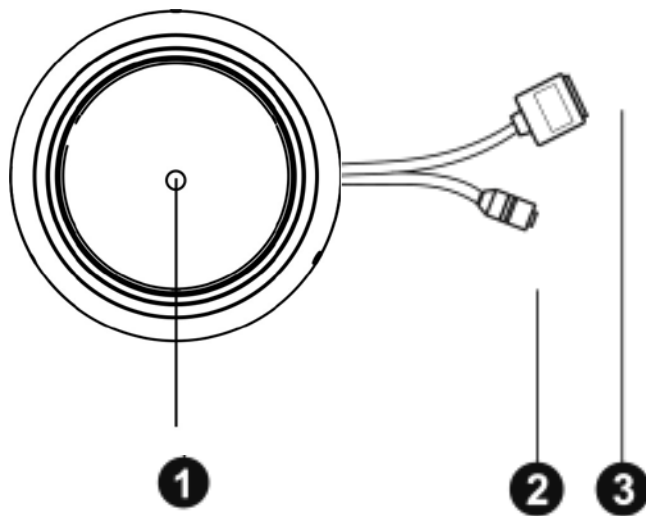

NO	Name	Description
1	Lens	Allows wide area to be monitored
2	Power Cable	Cable for Power source (DC 12V)
3	Ethernet Cable	Cable for Ethernet (POE)

- **Camera Dimension**

See the diagrams below for the exact dimension

Dimensions

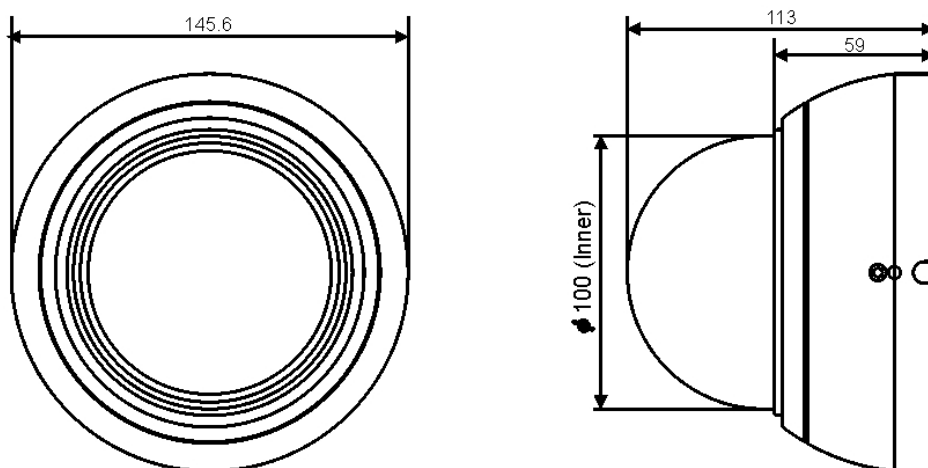

Unit: mm

2. Installation

2.1 Camera Installation

1. Make mounting holes and cable hole in the place (ceiling or wall) to which this dome camera is installed using the Drilling guide label.

● IR CAMERA TYPE

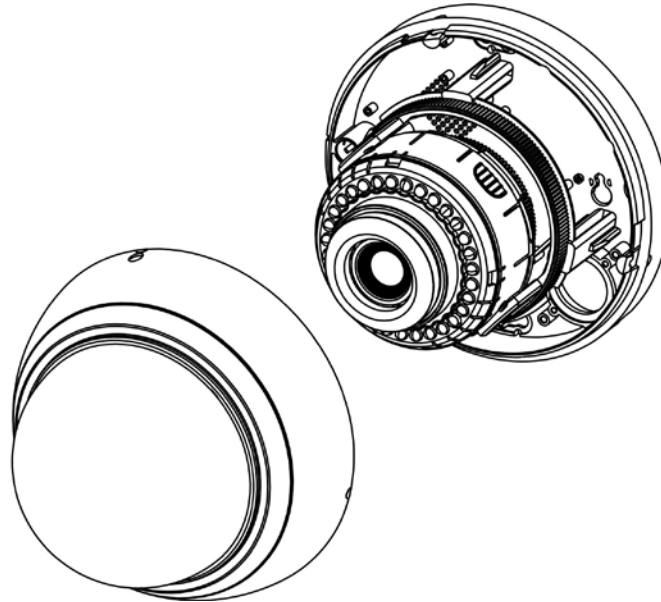

2. To remove dome cover, turn the dome body counterclockwise until locators reach end of travel and pull off.
Push the liner on the sides where the patterns are put in the teeth of a comb and pull it out.

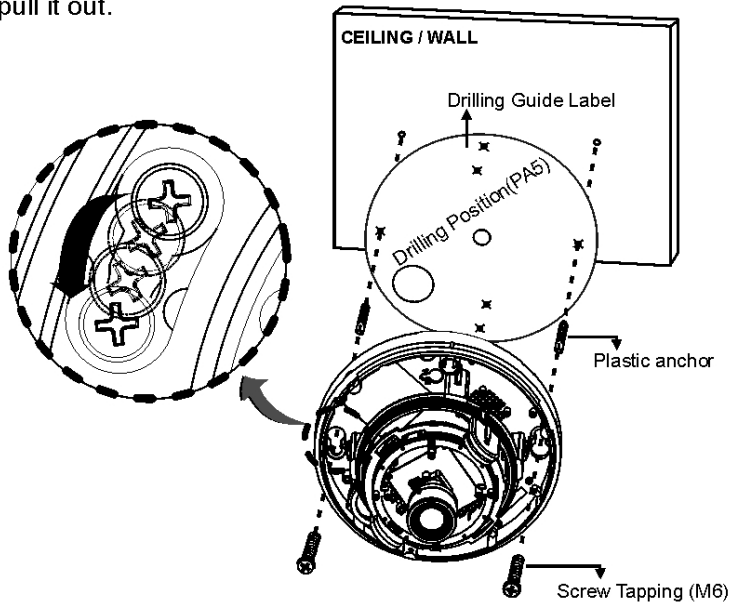

3. Attach the housing to the ceiling using suitable fasteners, M6x35 tapping screws are supplied only use if they are suitable.
Turn the housing to right direction about 16 degrees to lock in place.
4. The assembly of the dome body and liner is in reverse order of disassembly.
Finally, lock dome body with locking screw(M3X5) from the accessory kit.

- **Micro SD memory slot**
Insert the SD memory card.

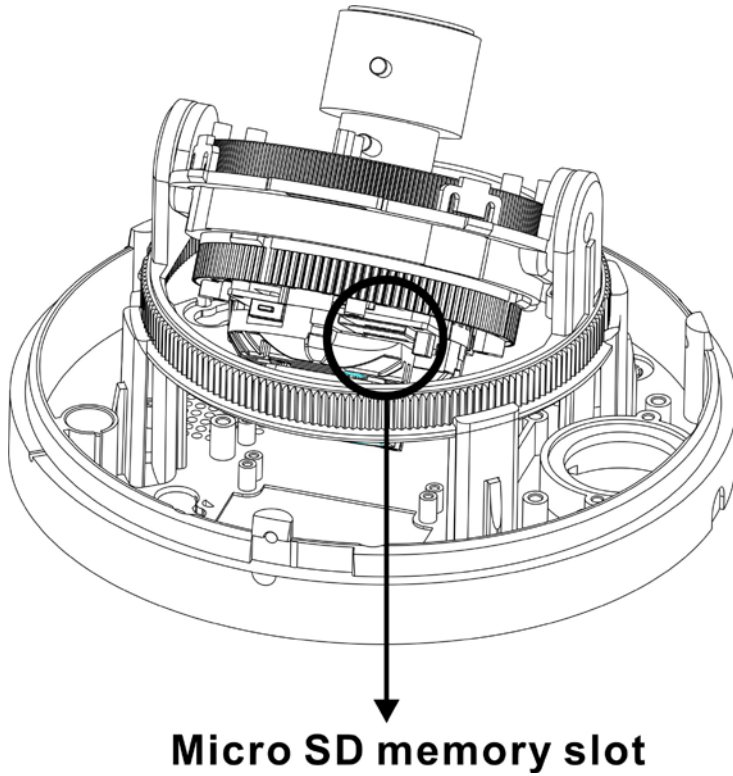

- **Connecting the Power**
Connect the DC 12V power adaptor to the camera.

2.2 Network Connection and IP assignment

The Network Camera supports the operation through the network. When a camera is first connected to the network it has no assigned IP address. So, it is necessary to allocate an IP address to the device with the "eneo Scan Device" tool found on the supplied CD. The factory default IP is "192.168.1.10"

Note: For more information, refer to the eneo Scan Device tool manual.

3. Operation

The Network Camera can be used with Windows operating system and browsers. The recommended browsers are Internet Explorer, Safari, Firefox, Opera and Google Chrome with Windows.

NOTE: To view streaming video in Microsoft Internet Explorer, set your browser to allow ActiveX controls.

3.1 Access from a browser

1. Start a browser (Internet Explorer).
2. Enter the IP address or host name of the Network Camera in the Location/Address field of your browser.
3. You can see a starting page. Click Live View or Setup to enter web page.



4. The network camera's **Live View** page appears in your browser.

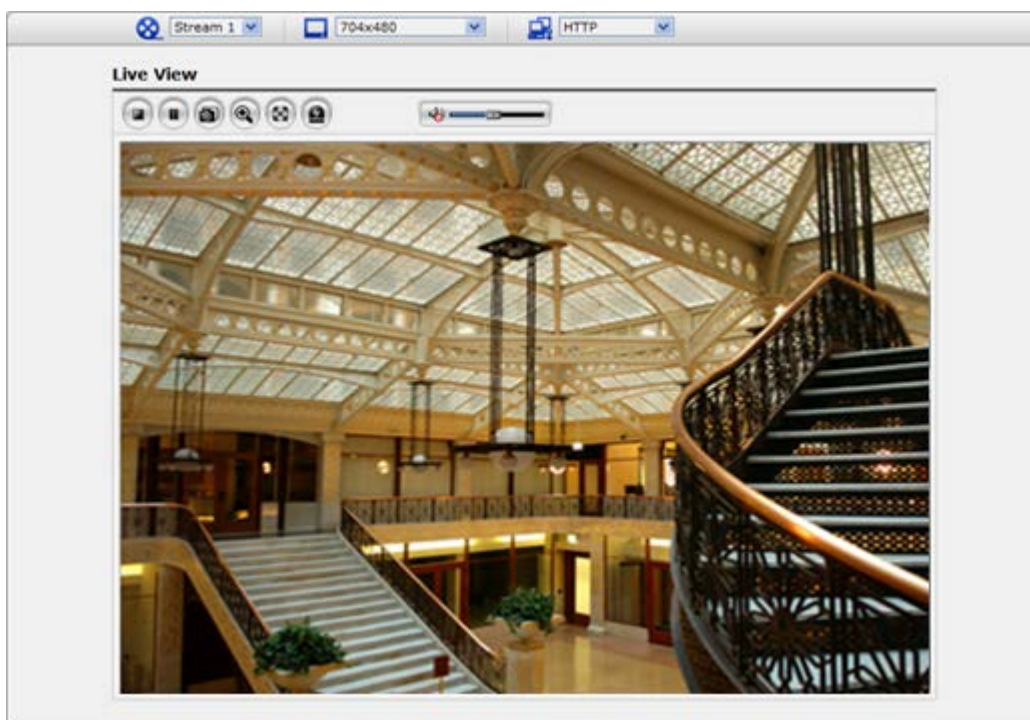

3.2. Access from the internet

Access from the internet once connected, the Network Camera is accessible on your local network (LAN). To access the network camera from the Internet you must configure your broadband router to allow incoming data traffic to the network camera. To do this, enable the NAT-traversal feature, which will attempt to automatically configure the router to allow access to the network camera. This is enabled from Setup > System > Network > NAT.

For more information, please see "3.5.5 System>Network>NAT" of User's Manual.

3.3 Setting the admin password over a secure connection

To gain access to the product, the password for the default administrator user must be set. This is done in the "Admin Password" dialog, which is displayed when the network camera is accessed for the setup at the first time. Enter your admin name and password, set by the administrator.

Note: The default administrator username is admin and password is admin. If the password is lost, the Network Camera must be reset to the factory default settings. See "3.8 Resetting to the Factory Default Settings".

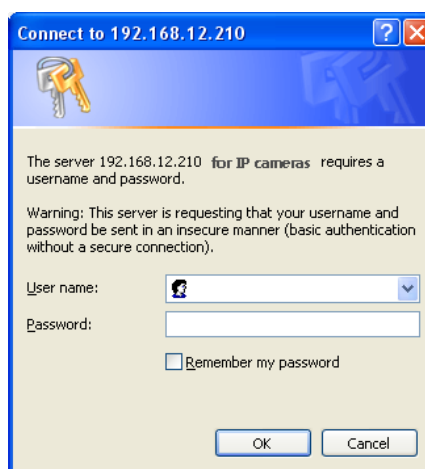

To prevent network eavesdropping when setting the admin password, this can be done via an encrypted HTTPS connection, which requires an HTTPS certificate (see note below).

To set the password via a standard HTTP connection, enter it directly in the first dialog shown below. To set the password via an encrypted HTTPS connection, see "3.5.5 System >Security>HTTPS".

Note: HTTPS (Hypertext Transfer Protocol over SSL) is a protocol used to encrypt the traffic between web browsers and servers. The HTTPS certificate controls the encrypted exchange of information.

3.4 Live View Page

The live view page comes in several screen modes: 1920x1080, 1280x1024, 1280x720, 800x600, 704x480(576), 640x480, 352x240(288) and 320x240. Users are allowed to select the most suitable one out of those modes. Please, adjust the mode in accordance with your PC specifications and monitoring purposes.

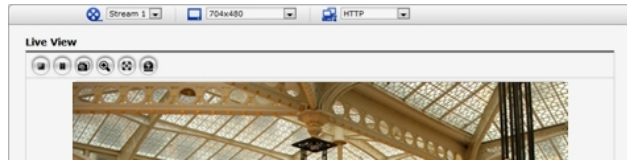

1) General controls

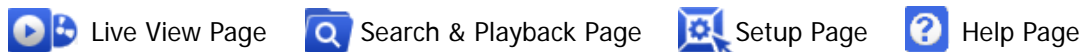

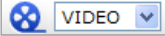

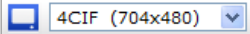

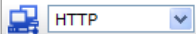

 VIDEO The video drop-down list allows you to select a customized or pre-programmed video stream on the live view page. Stream profiles are configured under Setup > Basic Configuration > Video & Image. For more information, please see “3.5.1 Basic Configuration > Video & Image” of User’s Manual

 4CIF (704x480) The resolution drop-down list allows you to select the most suitable one out of video resolutions to be displayed on live view page.

 HTTP The protocol drop-down list allows you to select which combination of protocols and methods to use depends on your viewing requirements, and on the properties of your network.

2) Control toolbar

The live viewer toolbar is available in the web browser page only. It displays the following buttons:

-  The Stop button stops the video stream being played. Pressing the key again toggles the start and stop. The Start button connects to the network camera or start playing a video stream.
-  The Pause button pause the video stream being played.
-  The Snapshot button takes a snapshot of the current image. The location where the image is saved can be specified.
-  The digital zoom activates a zoom-in or zoom-out function for video image on the live screen.
-  The Full Screen button causes the video image to fill the entire screen area. No other windows will be visible. Press the 'Esc' button on the computer keyboard to cancel full screen view.
-  The Manual Trigger button activates a pop-up window to manually start or stop the event.

3) Video Streams

The network camera provides several images and video stream formats. Your requirements and the properties of your network will determine the type you use.

The Live View page in network camera provides access to H.264, MPEG-4 and Motion JPEG video streams, and to the list of available video streams. Other applications and clients can also access these video streams/images directly, without going via the Live View page.

3.5 Network Camera Setup

This section describes how to configure the network camera, and is intended for product Administrators, who have unrestricted access to all the Setup tools; and Operators, who have access to the settings for Basic, Live View, Video & Image and System Configuration.

You can configure the network camera by clicking Setup in the top right-hand corner of the Live View page. Click on this page to access the online help that explains the setup tools

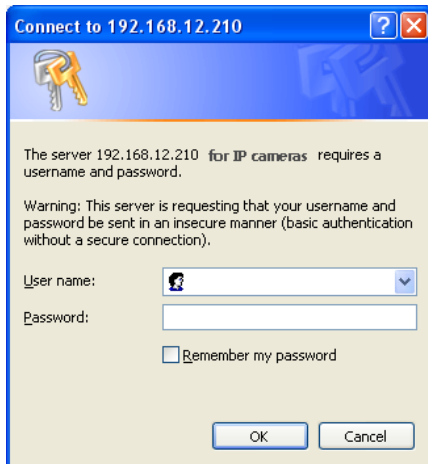

When accessing the Network Camera for the first time, the “Admin Password” dialog appears. Enter your admin name and password, set by the administrator.

Note: If the password is lost, the Network Camera must be reset to the factory default settings. See “3.8 Resetting to the Factory Default Settings”.

3.5.1 Basic Configuration

You can see the device information in this information page.

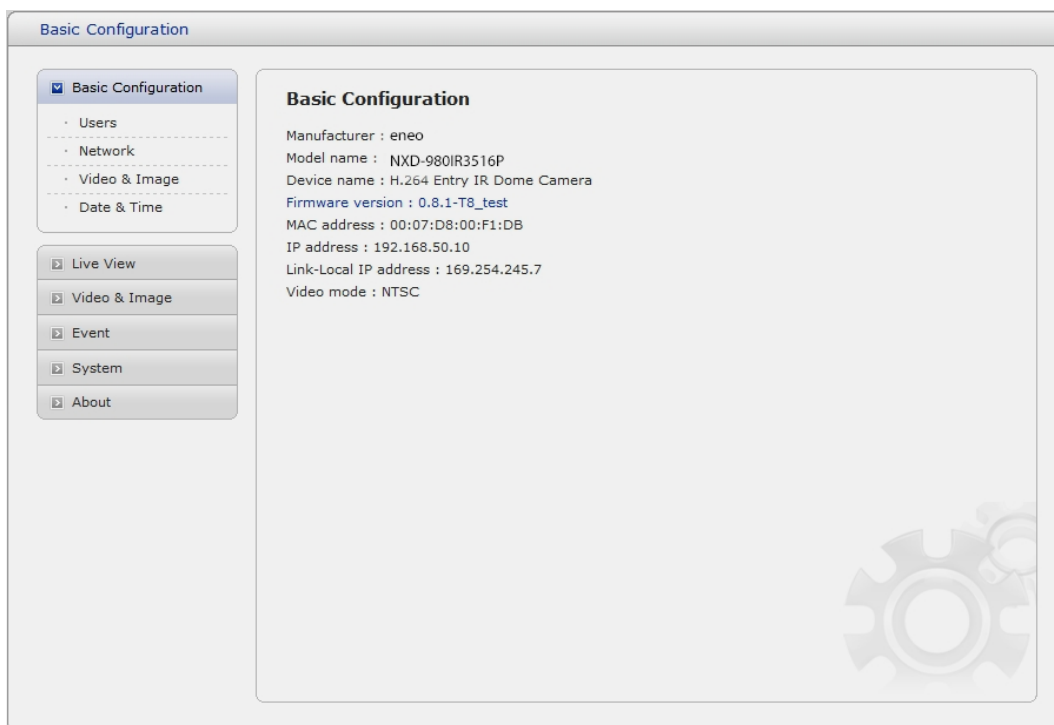

1) Users

User access control is enabled by default. An administrator can set up other users, by giving these user names and passwords. It is also possible to allow anonymous viewer login, which means that anybody may access the Live View page, as described below:

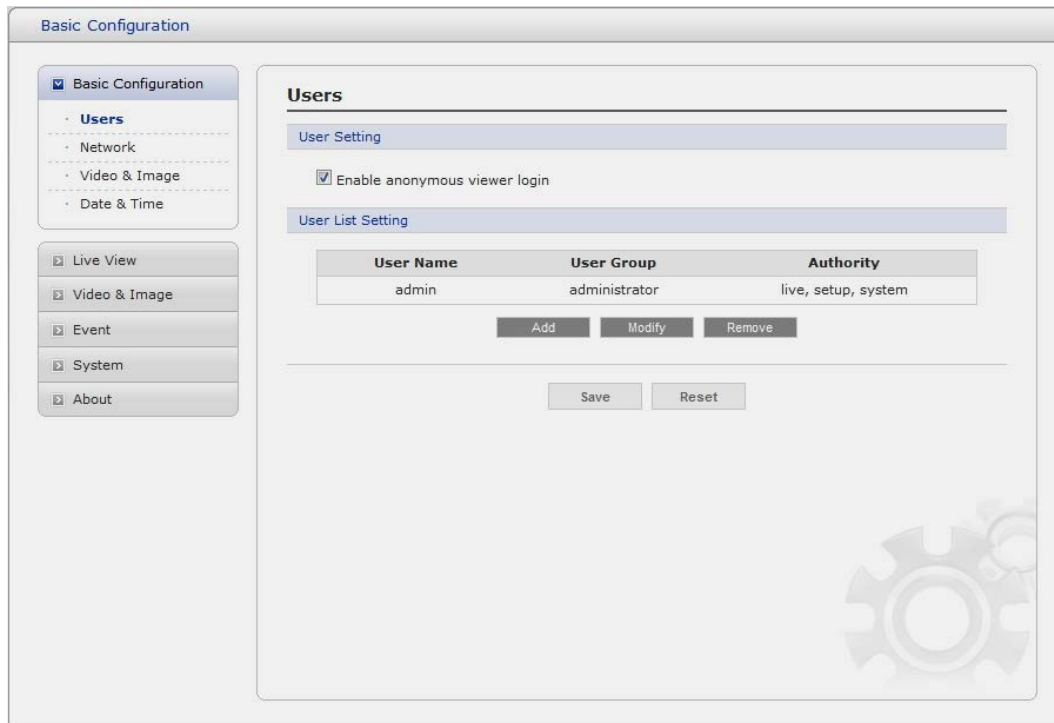

The **user list** displays the authorized users and user groups (levels):

User Group	Authority
Guest	Provides the lowest level of access, which only allows access to the Live View page.
Operator	An operator can view the Live View page, create and modify events, and adjust certain other settings. Operators have no access to System Options.
Administrator	An administrator has unrestricted access to the Setup tools and can determine the registration of all other users.

- **Enable anonymous viewer login:** Check the box to use the webcasting features. Refer to "3.5.2 Video & Image" for more details.

2) Network

The network camera supports both IP version 4 and IP version 6. Both versions may be enabled simultaneously, and at least one version must always be enabled. When using IPv4, the IP address for the network camera can be set automatically via DHCP, or a static IP address can be set manually. If IPv6 is enabled, the network camera receive an IP address according to the configuration in the network router. There is also the option of using the Internet Dynamic DNS Service. For more information on setting the Network, please see Setup> System>Security>Network.

The screenshot shows a web-based configuration interface for a network camera. The main heading is 'Basic Configuration'. On the left, there is a sidebar menu with options: Basic Configuration (selected), Users, Network (selected), Video & Image, Date & Time, Live View, Video & Image, Event, System, and About. The main content area is titled 'Network' and contains an 'IP Address Configuration' section. Two radio buttons are present: 'Obtain IP address via DHCP' (unselected) and 'Use the following IP address:' (selected). Below these are three input fields: 'IP address' with the value '192 . 168 . 50 . 10', 'Subnet mask' with '255 . 255 . 255 . 0', and 'Default router' with '192 . 168 . 50 . 1'. At the bottom of the configuration area are 'Save' and 'Reset' buttons. A faint gear icon is visible in the background of the main content area.

- **Obtain IP address via DHCP** - Dynamic Host Configuration Protocol (DHCP) is a protocol that lets network administrators centrally manage and automate the assignment of IP addresses on a network. DHCP is enabled by default. Although a DHCP server is mostly used to set an IP address dynamically, it is also possible to use it to set a static, known IP address for a particular MAC address.
- **Use the following IP address** - To use a static IP address for the Network Camera, check the radio button and then make the following settings:
 - **IP address** - Specify a unique IP address for your Network Camera.
 - **Subnet mask** - Specify the mask for the subnet the Network Camera is located on.
 - **Default router** - Specify the IP address of the default router (gateway) used for connecting devices attached to different networks and network segments.

Notes:

1. DHCP should only be enabled if using dynamic IP address notification, or if your DHCP server can update a DNS server, which then allows you to access the Network Camera by name (host name). If DHCP is enabled and you cannot access the unit, you may have to reset it to the factory default settings and then perform the installation again.
2. The ARP/Ping service is automatically disabled two minutes after the unit is started, or as soon as an IP address is set.
3. Pinging the unit is still possible when this service is disabled.

3) Video & Image

The screenshot displays the 'Basic Configuration' window for 'Video & Image' settings. On the left, a sidebar contains a tree view with 'Basic Configuration' selected, and sub-items: 'Users', 'Network', 'Video & Image', and 'Date & Time'. Below this are buttons for 'Live View', 'Video & Image', 'Event', 'System', and 'About'. The main area is titled 'Video & Image' and contains three sections: 'Stream 1 Setting', 'Stream 2 Setting', and 'Stream 3 Setting'. Each section has a title bar and a list of settings with dropdown menus and input fields. 'Stream 1 Setting' includes Codec (H.264 Baseline Profile), Resolution (1920x1080), Bitrate control (CBR), Bitrate (4000 [Kbps]), Framerate (30), and GOP size (30 [1...60]). 'Stream 2 Setting' includes Codec (MJPEG), Resolution (640x480), Framerate (30), and Quality (50 [1...100]). 'Stream 3 Setting' includes Codec (H.264 Baseline Profile), Resolution (Same as Stream 2), Bitrate control (CBR), Bitrate (1000 [Kbps]), Framerate (5), and GOP size (5 [1...10]). At the bottom right, there are 'Save' and 'Reset' buttons. A faint gear icon is visible in the background of the main area.

- **Stream1 Setting**

- **Codec:**

- The codec settings are separated into MPEG4 and H.264.

- H.264 is also known as MPEG-4 Part 10. This is the new generation compression standard for digital video. This function offers higher video resolution than Motion JPEG or MPEG-4 at the same bit rate and bandwidth, or the same quality video at a lower bit rate.

- **Profile:**

- There are 4 pre-programmed stream profiles available for quick set-up.

- Choose the form of video encoding you wish to use from the drop-down list:

- * **H.264 HP(High Profile):** The primary profile for broadcast and disc storage applications, particularly for high-definition television applications (for example, this is the profile adopted by the Blu-ray Disc storage format and the DVB HDTV broadcast service).

- * **H.264 MP(Main Profile):**

- Primarily for low-cost applications that requires additional error robustness, this profile is used rarely in videoconferencing and mobile applications, it does add additional error resilience tools to the Constrained Baseline Profile. The importance of this profile is fading after the Constrained Baseline Profile has been defined.

- * **H.264 BP(Baseline Profile):**
Originally intended as the mainstream consumer profile for broadcast and storage applications, the importance of this profile faded when the High profile was developed for those applications.
- * **MPEG4 SP(Simple Profile):**
Mostly aimed for use in situations where low bit rate and low resolution are mandated by other conditions of the applications, like network bandwidth, device size etc.

- **Resolution:**

It enables users to determine a basic screen size when having an access through the Web Browser or PC program. The screen size control comes in seven modes like 1920x1080, 1280x720, 640x480, 352x240, and 320x240. Users can reset the selected screen size anytime while monitoring the screen on a real-time basis.

- **Bitrate control:**

Limiting the bit rate helps control the bandwidth used by the H.264 or MPEG-4 video stream. Leaving the Maximum bit rate as 8000Kbps maintains consistently good image quality but increases bandwidth usage when there is more activity in the image. Limiting the bit rate to a defined value prevents excessive bandwidth usage, but images are lost when the limit is exceeded.

Note that the bit rate control can be used for constant bit rates only.

The bit rate can be set as Variable Bit Rate (VBR) or Constant Bit Rate (CBR). VBR adjusts the bit rate according to the image complexity, using up bandwidth for increased activity in the image, and less for lower activity in the monitored area.

CBR allows you to set a fixed target bitrate that consumes a predictable amount of bandwidth. As the bit rate would usually need to increase for increased image activity, but in this case cannot, the frame rate and image quality are affected negatively. To partly compensate for this, it is possible to prioritize either the frame rate or the image quality whenever the bit rate needs to be increased. Not setting a priority means the frame rate and image quality are equally affected.

- **Frame rate:**

Upon the real-time play, users should select a frame refresh rate per second. If the rate is high, the image will become smooth. On the other hand, if the rate is low, the image will not be natural but it can reduce a network load.

- **GOP size:**

Select the GOP(Group of Picture) size. If users want to have a high quality of fast image one by one, please decrease the value. For the purpose of general monitoring, please do not change a basic value. Such act may cause a problem to the system performance. For the details of GOP setting, please contact the service center.

- **Stream2 Setting**

Sometimes the image size is large due to low light or complex scenery. Adjusting the frame rate and quality helps to control the bandwidth and storage used by the Motion JPEG video stream in these situations. Limiting the frame rate and quality optimizes bandwidth and storage usage, but may give poor image quality. To prevent increased bandwidth and storage usage, the Resolution, Frame rate, and Frame Quality should be set to an optimal value.

- **JPEG resolution:** Same as the Stream1 Setting.
- **JPEG frame rate:** Same as the Stream1 Setting.
- **JPEG quality:**
Select the picture quality. If users want to have a high quality of fast image one by one, please decrease the value. For the purpose of general monitoring, please do not change a basic value. Such act may cause a problem to the system performance.
- **Stream3 Setting**
 - **Codec:** Same as the Stream1 Setting.
 - **Resolution:** Select the Stream1 resolution or the Stream2 resolution.
 - **Bitrate control:** Same as the Stream1 Setting.
 - **Frame rate:** Same as the Stream1 Setting.
 - **GOP size:** Same as the Stream1 Setting.

When satisfied with the settings, click **Save**, or click **Reset** to revert to previously saved settings.

4) Date & Time

- **Current Server Time**
It displays the current date and time (24h clock). The time can be displayed in 12h clock format in the overlay (see below).
- **New Server Time**
Select your time zone from the drop-down list. If you want the server clock to automatically adjust for daylight savings time, select the “Automatically adjustment for daylight saving time changes”.

From the **Time Mode** section, select the preferred method to use for setting the time:

- **Synchronize with computer time:** sets the time from the clock on your computer.
- **Synchronize with NTP Server:** the network camera will obtain the time from an NTP server every 60 minutes.
- **Set manually:** this option allows you to manually set the time and date.
- **Date & Time Format**
Specify the formats for the date and time (12h or 24h) displayed in the video streams.
Select Date & Time format from the drop-down list.
 - **Date Format:** Specify the date format. YYYY: Year, MM: Month, DD: Day
 - **Time Format:** Specify the date format. 24Hours or 12 Hours

3.5.2 Live View

▼ Source

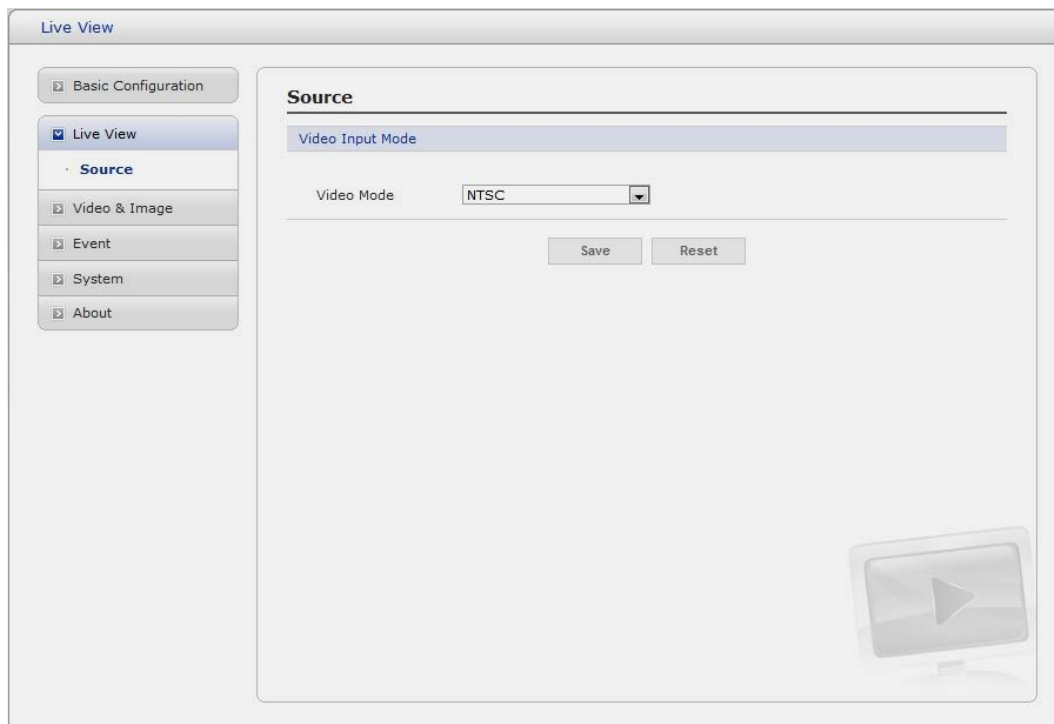

- **Video Input Mode**
 - **Video Mode:**
Choose Video Mode you wish to use from the drop-down list: NTSC or PAL

3.5.3 Video & Image

▼ Basic

The screenshot displays the 'Video & Image' configuration window. On the left is a sidebar with a tree view containing: Basic Configuration, Live View, Video & Image (selected), Event, System, and About. Under 'Video & Image', there are sub-items: Basic, Image, AE & AWB, Day & Night, Privacy Masking, and Webcasting. The main area is titled 'Video & Image - Basic' and contains three sections: 'Sensor Setting', 'Stream 1 Setting', 'Stream 2 Setting', and 'Stream 3 Setting'. Each section has several configuration options with dropdown menus and input fields. At the bottom right, there is a 'Save' button, a 'Reset' button, and a decorative graphic of a film reel and clapperboard.

Section	Parameter	Value
Sensor Setting	Capture mode	1600x1200 Max. 15fps
Stream 1 Setting	Codec	H.264 Baseline Profile
	Resolution	1600x1200
	Bitrate control	CBR
	Bitrate	4000 [Kbps]
	Framerate	15
GOP size	15 [1 ...30]	
Stream 2 Setting	Codec	MJPEG
	Resolution	640x480
	Framerate	15
	Quality	50 [1 ...100]
Stream 3 Setting	Codec	H.264 Baseline Profile
	Resolution	Same as Stream 1
	Bitrate control	CBR
	Bitrate	1000 [Kbps]
	Framerate	15
GOP size	15 [1 ...30]	

Refer to "3.5.1 Basic Configuration > Video & Image" for more details.

▼ Image

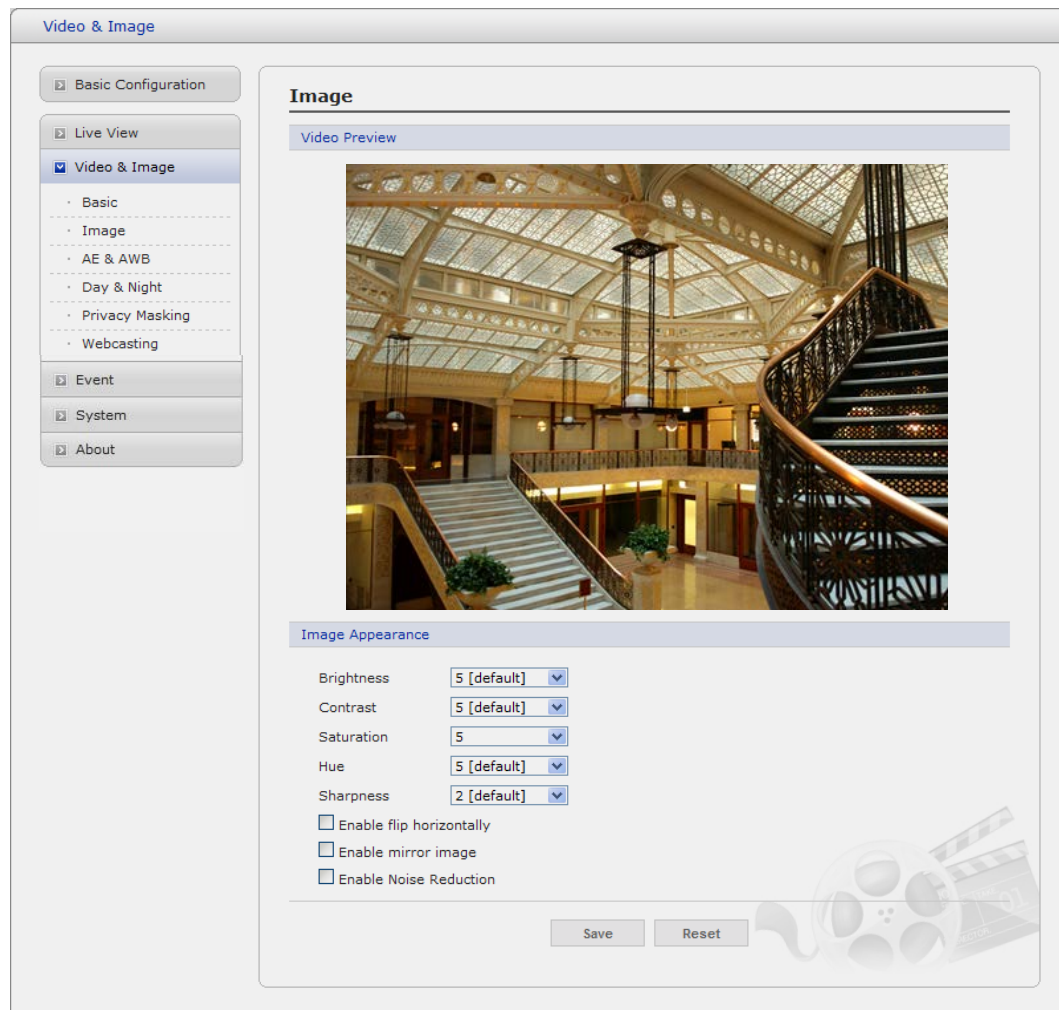

- **Image Appearance**

This page provides access to the advanced image settings for the network camera.

- **Brightness:** The image brightness can be adjusted in the range 1-10, where a higher value produces a brighter image.
- **Contrast:** The image contrast can be adjusted in the range 1-10.
- **Saturation:** Adjust the image's contrast by raising or lowering the value in this field.
- **Hue:** The image hue can be adjusted in the range 1-10.
- **Sharpness:** Controls the amount of sharpening applied to the image. A sharper image might increase image noise especially in low light conditions. A lower setting reduces image noise, but the image would be less sharp.
- **Enable flip image:** Check this box to flip the image.
- **Enable mirror image:** Check this box to mirror the image.
- **Enable Noise Reduction:** Check this box to reduce an image noise.

▼ AE & AWB

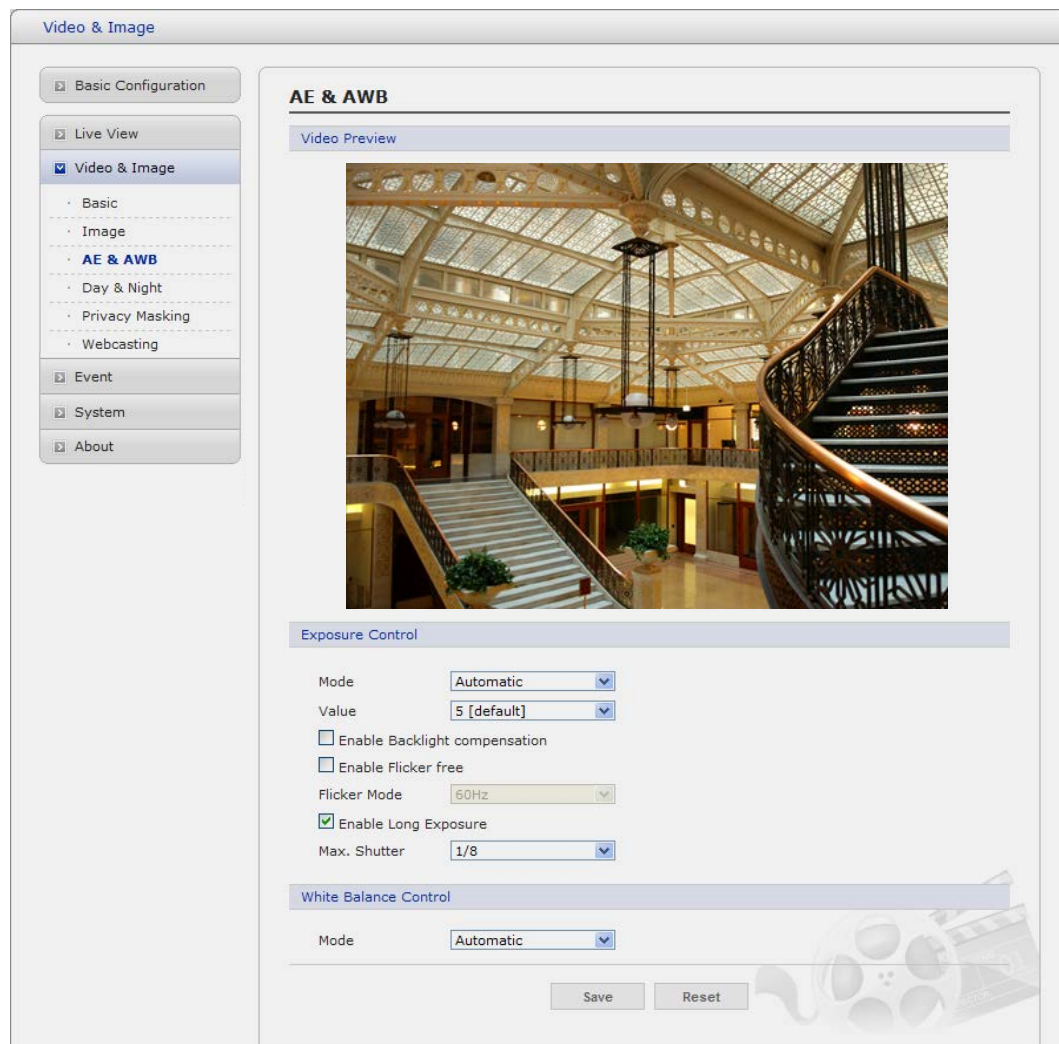

- **Exposure control**

This page provides access to the advanced exposure control settings for the network camera.

- **Mode:** Supports exposure modes to control the amount of light detected by the camera sensor based on settings for light conditions. The default setting is Auto mode.
- * **Automatic:** Automatically sets the amount of light detected by the image sensor.
- * **Hold Current:** Fixes the exposure at its current state.
- **Value:** Select a value in the drop-down list to tune the exposure. The default setting is 5.
- **Enable Backlight Compensation:** Set this checkbox to activate the BLC operation.
- **Flicker Mode** - Provides the options for flicker.
- * **50Hz:** Select at 50 Hz environments.
- * **60Hz:** Select at 60 Hz environments.
- **Enable Long Exposure:** Set this checkbox to activate the electronic shutter of the camera.
- * **Max. Shutter:** Select a shutter speed value in the drop-down list. The default setting is 1/15.

- **White Balance Control**

This adjusts the relative amount of red, green and blue primary colors in the image so that the neutral colors are reproduced correctly. The camera can be set to automatically adjust for the type of light and compensate for its color. Alternatively, the type of light source can be set manually.

From the drop-down list, select the white balance setting suitable for the lighting used for your camera. The available options are:

- **Automatic:** Automatic identification and compensation for the light source color. This can be used in most situations and is the recommended setting.
- **Fixed Incandescent:** Fixed color adjustment, ideal for a room with incandescent (a glow) lighting and good for a normal color temperature around 2600K.
- **Fixed Fluorescent:** Fixed color adjustment; good for fluorescent lighting with a color temperature around 4000K to 5000K.
- **Fixed Outdoor:** Fixed color adjustment for sunny, with a color temperature around 6500K to 7500K.

▼ Day & Night

The screenshot shows a web-based configuration interface for a camera. The main title is 'Video & Image'. On the left, there is a sidebar menu with categories: Basic Configuration, Live View, Video & Image (selected), Event, System, and About. Under 'Video & Image', sub-items include Basic, Image, AE & AWB, Day & Night (selected), Privacy Masking, and Webcasting. The main content area is titled 'Day & Night' and contains a 'Video Preview' window showing a live view of a grand, multi-story building interior with a large glass and steel atrium and a curved staircase. Below the preview, there are two control sections: 'Day & Night Control' and 'IR Control'. In the 'Day & Night Control' section, 'Mode' is set to 'Automatic' and 'Threshold' is set to 'High'. In the 'IR Control' section, 'Enable IR' is checked and 'Max. Strength' is set to '5'. At the bottom right of the configuration area, there are 'Save' and 'Reset' buttons. A faint watermark of a film reel is visible in the bottom right corner of the interface.

- **Day & Night Control**

Select the day/night mode from among three modes.

- **Mode:** Normally works in day mode. It switches automatically to night mode in a dark place.
- * **Automatic:** Normally works in day mode. It switches automatically to night mode in a dark place.
- * **Day:** Always works in day mode.
- * **Night:** Always works in night mode.

- **Threshold**

Select the day/night mode threshold.

- * **High:** quickly changes to day mode, but slowly changes to night mode.
- * **Low:** quickly changes to night mode, but slowly changes to day mode.

- **IR Control**

- **Enable IR:** Set this checkbox to activate IR operation.
- * **Max Strength:** Select a value in the drop-down list to tune the strength. The default setting is 5.

▼ Privacy Masking

The privacy masking function allows you to mask parts of the video image to be transmitted. You can set up to eight privacy masks and the color of privacy masks is black.

The screenshot displays a web-based configuration interface for a video camera. The main window is titled "Video & Image" and contains a sidebar with navigation tabs: "Basic Configuration", "Live View", "Video & Image" (selected), "Event", "System", and "About". Under "Video & Image", there are sub-tabs for "Basic", "Image", "AE & AWB", "Day & Night", "Privacy Masking" (selected), and "Webcasting".

The "Privacy Masking" section is active and shows a "Video Preview" window. The preview displays a video feed of a modern building interior with two black rectangular masks overlaid. The top mask is labeled "Mask Window1" and the bottom mask is labeled "Mask Window2".

Below the preview is the "Privacy Masking Setting" section, which includes a checkbox for "Enable privacy masking" (currently unchecked). Below this is a table with three columns: "ID", "Name", and "Delete".

ID	Name	Delete
----	------	--------

At the bottom of the settings section are "Save" and "Reset" buttons.

The privacy masks are configured by Mask windows. Each window can be selected by clicking with the mouse. It is also possible to **resize or delete, or move** the window, by selecting the appropriate window at the mouse menu on the video screen.



To create a mask window, follow steps:

1. Click the right button of mouse to see the mouse menu.
2. Select New Privacy Mask in the mouse menu.
3. Click and drag mouse to designate a mask window area.

You can also modify or delete a mask window index. Select an index and then, modify items or delete button. Select "Enable" to activate the privacy masking function.

▼ Webcasting

The network camera can stream live video to a website. Copy the HTML code generated on the screen and pastes it in page code of the website you want to display live video.

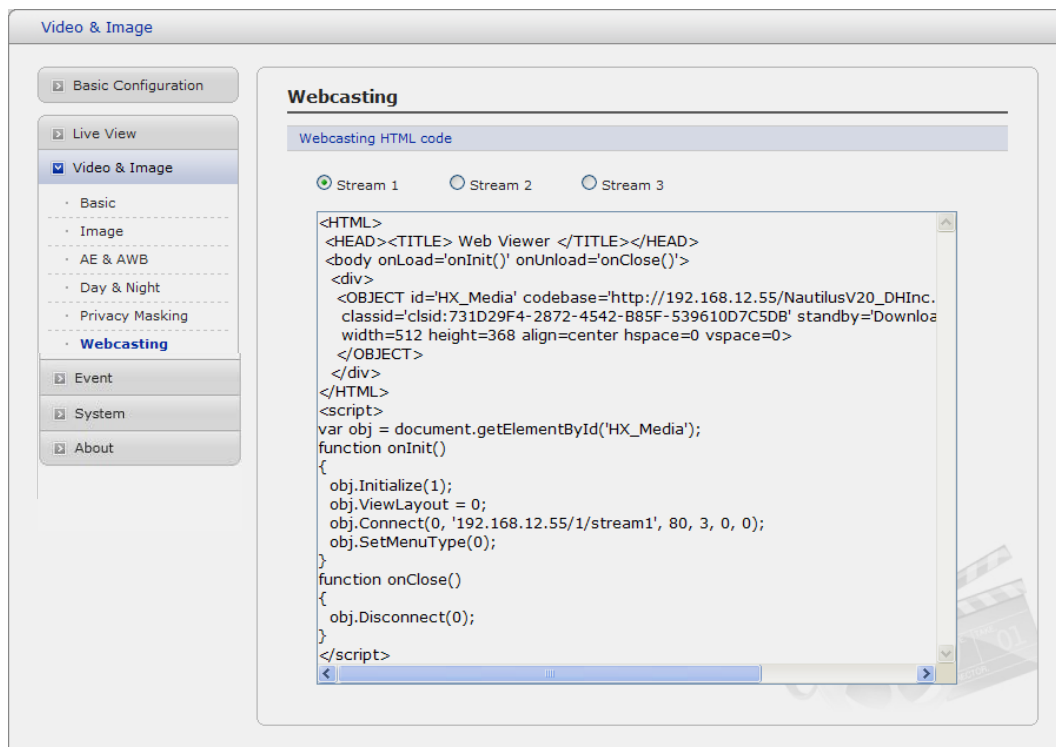

Note: To use webcasting service, the Enable Anonymous viewer login option must be checked. Refer to "3.5.1 Basic Configuration > Users" for more details.

3.5.4 Event

1) Event-In

▼ On Boot

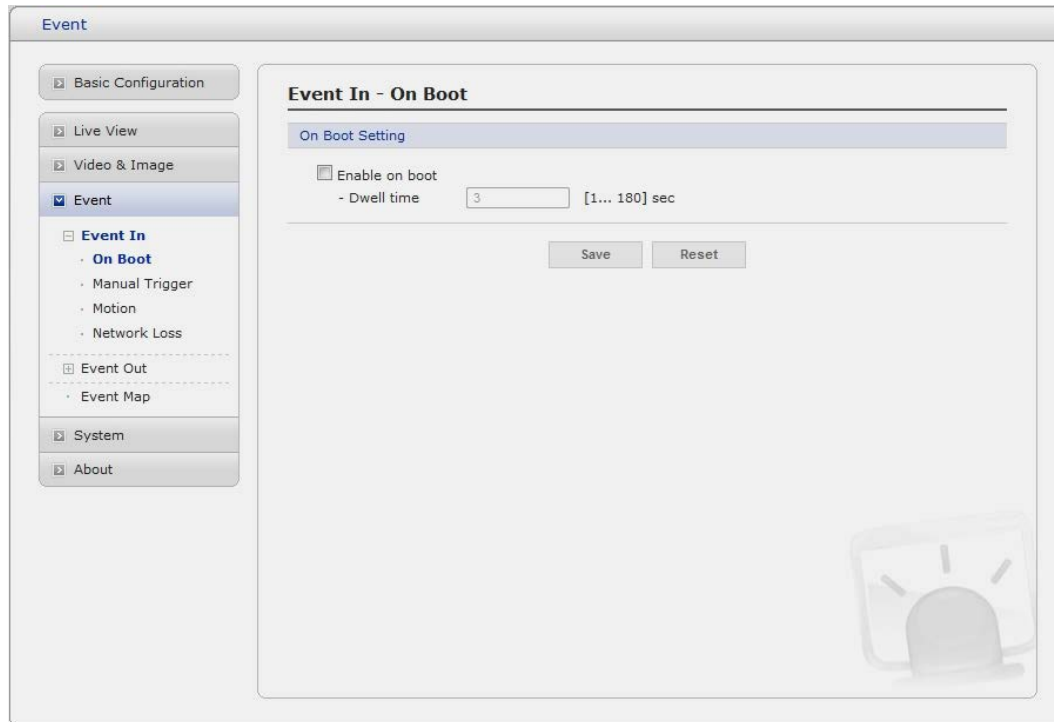

This is used to trigger the event every time the Network Camera is started. Select "Enable" to activate the motion event.

▼ Manual Trigger

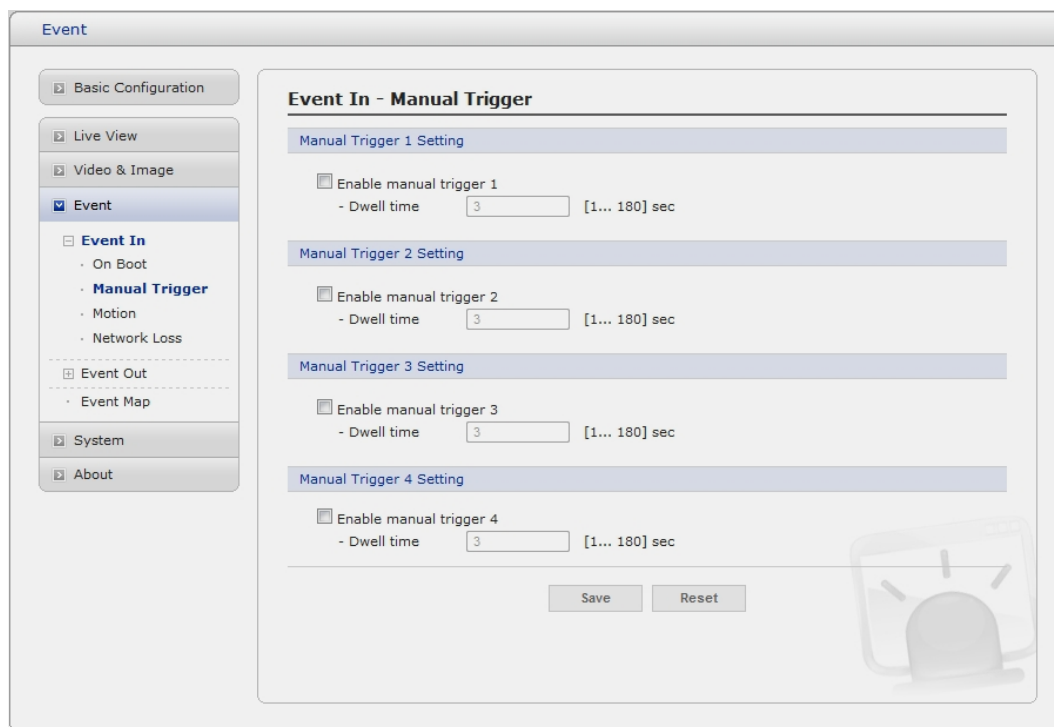

The screenshot shows a web interface for configuring manual triggers. On the left is a sidebar menu with the following items: Basic Configuration, Live View, Video & Image, Event (selected), Event In (expanded), On Boot, Manual Trigger (selected), Motion, Network Loss, Event Out (expanded), Event Map, System, and About. The main content area is titled 'Event In - Manual Trigger' and contains four sections, each for a manual trigger setting:

- Manual Trigger 1 Setting**: Enable manual trigger 1, Dwell time: 3 [1... 180] sec
- Manual Trigger 2 Setting**: Enable manual trigger 2, Dwell time: 3 [1... 180] sec
- Manual Trigger 3 Setting**: Enable manual trigger 3, Dwell time: 3 [1... 180] sec
- Manual Trigger 4 Setting**: Enable manual trigger 4, Dwell time: 3 [1... 180] sec

At the bottom of the main content area are 'Save' and 'Reset' buttons. A faint image of a manual trigger button is visible in the bottom right corner of the interface.

This option makes use of the manual trigger button provided on the live view page, which are used to start or stop the event type manually. Alternatively the event can be triggered via the product's API (Application Programming Interface).

▼ Motion

Event In - Motion

Video Preview

Video Motion Detection Setting

Enable video motion detection

Day Day & Night

ID	Name	Type	Threshold	Sensitivity	Dwell	Delete
1	New	Include	2	55	3	X
			7	40		
2	New(1)	Include	2	55	3	X
			7	40		

Save Reset

Motion detection is used to generate an alarm whenever movement occurs (or stops) in the video image. A total of 8 Motion and/or Mask windows can be created and configured.

Motion is detected in defined **Motion** windows, which are placed in the video image to target specific areas. Movement in the areas outside the motion windows will be ignored. If part of a motion window needs to be masked, this can be configured in a **Mask** window.

- **Pre-Viewer**

Motion detection windows are configured by Motion or Mask windows. Each window can be selected by clicking with the mouse. It is also possible to **resize or delete, or move** the window, by selecting the appropriate window at the mouse menu on the video screen.

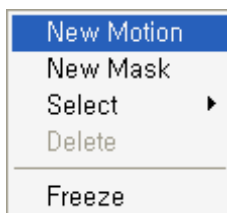

To create a motion or mask window, follow steps:

1. Click the right button of mouse to see the mouse menu.
2. Select New Motion (or Mask) Window in the mouse menu.
3. Click and drag mouse to designate a motion area.

- **Motion Detection Setting**

The behavior for each window is defined by adjusting the Threshold and Sensitivity, as described below.

A motion index is a set of parameters describing Window Name, Type, Threshold, Sensitivity, and Dwell Time. Window Types is one of Motion and Mask windows.

- **Threshold:** Sets up the threshold for the motion detection.
- **Sensitivity:** Sets up the sensitivity for the motion detection.
- **Dwell Time:** Set the hold time an event lasts for the specified hold time from the point of detection of a motion.

You can also modify or delete a motion index. Select an index and then, click the Modify or Delete button.

Select "Enable" to activate the motion window.

▼ Network Loss

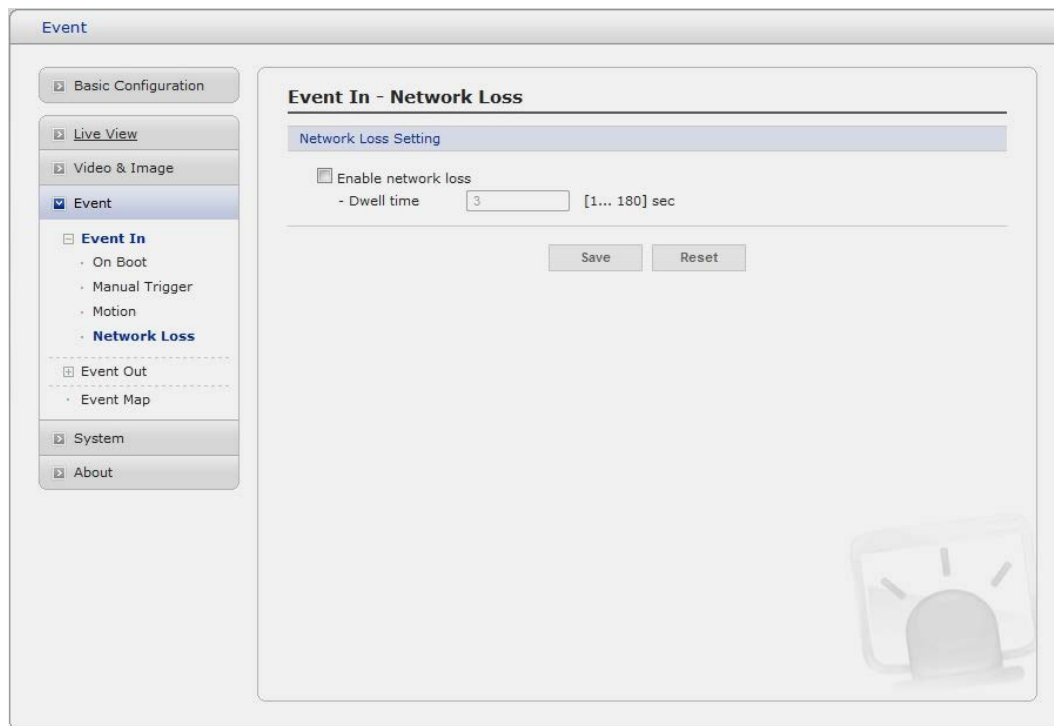

This is used to trigger the event every time the network connection is failed. Select "Enable" to activate the Network Loss event.

2) Event-Out

▼ SMTP(E-Mail)

The screenshot shows the 'Event Out - SMTP(E-Mail)' configuration page. On the left is a navigation menu with options like 'Basic Configuration', 'Live View', 'Video & Image', 'Event', 'Event In', 'Event Out', 'System', and 'About'. The 'Event Out' section is expanded to show 'SMTP(E-Mail)'. The main content area is titled 'Event Out - SMTP(E-Mail)' and contains three sub-sections: 'SMTP(E-Mail) Setting', 'SMTP(E-Mail) Receiver', and 'SMTP(E-Mail) Test'. The 'SMTP(E-Mail) Setting' section has a 'Enable SMTP' checkbox, a 'Sender' field, an 'Interval' field (60), an 'Aggregate events' field (50), a 'Use mail server' checkbox, a 'Mail server' field, a 'Port' field (25), a 'Connections security' dropdown (None), and an 'Enable use(SMTP) authentication' checkbox with 'User name', 'Password', and 'Login method' (AUTH LOGIN) fields. The 'SMTP(E-Mail) Receiver' section has eight input fields labeled Receiver 1 through Receiver 8. The 'SMTP(E-Mail) Test' section has a 'Receiver' field and a 'Test' button. At the bottom are 'Save' and 'Reset' buttons.

The Network Camera can be configured to send event and error email messages via SMTP (Simple Mail Transfer Protocol).

• SMTP(E-Mail) Setting

Select "Enable" to activate the SMTP operation.

- **Mail Server / Port:** Enter the host names (or IP addresses) and port numbers for your mail server in the fields provided, to enable the sending of notifications and image email messages from the camera to predefined addresses via SMTP.
- **Sender:** Enter the email address to be used as the sender for all messages sent by the Network Camera.
- **Interval:** Represents the frequency of the email notification when an event occurs.
- **Aggregate events:** Shows the maximum number of emails sent within each interval.

If your mail server requires authentication, check the box for Use authentication to log in to this server and enter the necessary information.

- **User Name/Password:** Enter the User Name and Password as provided by your network administrator or ISP (Internet Service Provider).

To ensure that the login procedure is performed as securely as possible when using SMTP authentication, you must define the weakest authentication method allowed.

- **Login Method:** Set the Weakest method allowed to the highest/safest method supported by the mail server. The most secure method is listed in the drop-down list:
Login / Plain
- **SMTP(E-Mail) Receiver**
 - **Receiver:** Enter an email address. You can also register the e-mail address of recipients up to 8.
- **SMTP(E-Mail) Test**
 - **Receiver:** Enter an email address and click the Test button to test that the mail servers are functioning and that the email address is valid.

▼ FTP & JPEG

When the network camera detects an event, it can record and save images to an FTP server. Images can be sent as e-mail attachments. Check the box to enable the service.

- **FTP Setting**
 - **Server:** Enter the server's IP address or host name. Note that a DNS server must be specified in the TCP/IP network settings if using a host name.
 - **Port:** Enter the port number used by the FTP server. The default is 21.
 - **Use passive mode:** Under normal circumstances the Network Camera simply requests the target FTP server to open the data connection. Checking this box issues a PASV command to the FTP server and establishes a passive FTP connection; whereby the Network Camera actively initiates both the FTP control and data connections to the target server. This is normally desirable if there is a firewall between the camera and the target FTP server.
 - **Remote directory:** Specify the path to the directory where the uploaded images will be stored. If this directory does not already exist on the FTP server, there will be an error message when uploading.
 - **User name/Password:** Provide your log-in information.

- **JPEG Setting**

- **Pre-event:** A pre-event buffer contains images from the time immediately preceding the event trigger. These are stored internally in the server. This buffer can be very useful when checking to see what happened to cause the event trigger.
Check the box to enable the pre-trigger buffer, enter the desired total length in seconds, minutes or hours, and specify the required image frequency.
- **Post-event:** This function is the counterpart to the pre-trigger buffer described above and contains images from the time immediately after the trigger. Configure as for pre-event.
- **Prefix file name:** This name will be used for all the image files saved. If suffixes are also used, the file name will take the form <prefix>.<suffix>.<extension>
- **Additional suffix:** Add either a date/time suffix or, a sequence number - with or without a maximum value

▼ **HTTP Server**

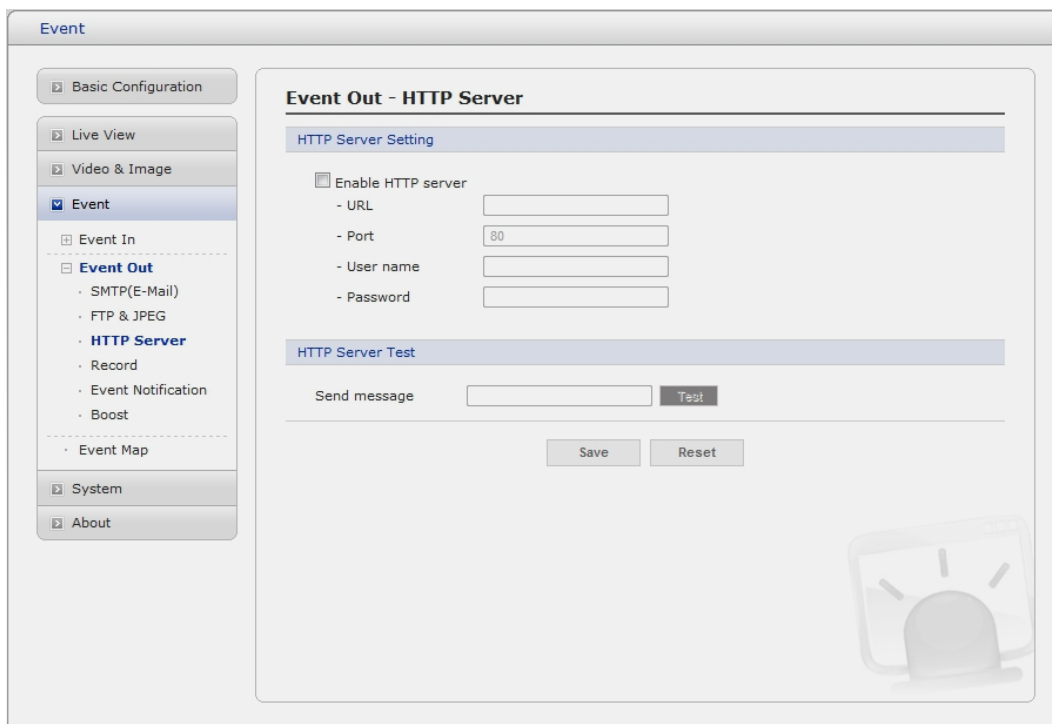

When the network camera detects an event, HTTP Server is used to receive uploaded image files and/or notification messages. Check the box to enable the service.

- **HTTP Server Setting**

- **Name:** The name of the HTTP event server. Use a descriptive name.
- **URL:** The network address to the server and the script that will handle the request.
For example: <http://192.168.12.244/cgi-bin/upload.cgi>
- **User name/Password:** Provide your log-in information.

- **HTTP Server Test**

When the setup is complete, the connection can be tested by clicking the Test button.

▼ Record

Event Out - Record

Record Setting

Enable Record

Overwrite

Continuous Record

* Note : Using continuous recording may shorten life time of SD card.

- Stream Type: Stream 1

- Pre-event: 0 [0... 10] sec

- Post-event: 0 [0... 60] sec

Record schedule

No Recording Recording

	0	1	2	3	4	5	6	7	8	9	10	11	12	13	14	15	16	17	18	19	20	21	22	23
SUN																								
MON																								
TUE																								
WED																								
THU																								
FRI																								
SAT																								

All Select All Delete

Device Setting

Device Type: SD

Format

Device Status : No Storage

Device Remove

Device Information

Total	Used	Available	Used Percent	Bad Sector
0.00MB	0.00MB	0.00MB	0.00%	0.00%

Save Reset

When the network camera detects an event, it can record video stream in the Micro SD Memory (not supplied) or NAS (Network Attached Device) as a storage device. Check the box to enable the service.

- **Record Setting**

- **Overwrite:** Click checkbox to overwrite the storage device.
- **Stream Type:** You can select Stream1, Stream2, or Stream3.
 - * **Stream1:** H.264 or MPEG-4 data
 - * **Stream2:** MJPEG data
 - * **Stream3:** You can select VIDEO or IMAGE.
- **Pre-event:** Enter pre-event time value for storage device pre-recording.
- **Post-event:** Enter post-event time value for storage device post-recording.

- **Record Schedule**

You can set the weekly recording schedule for each day. Drag or click area by a box unit at first. Clicking the block toggles the recording between on and off. Click the "All Select" button to set a schedule for the entire week or a whole day, respectively.

- **Device Setting**

Select Device Type to be recorded in the drop-down list.

- **SD:** built-in SD card
- **CIFS:** A file format for a NAS device.
- **NFS:** A file format for a NAS device.

Note1: Common Internet File System (CIFS) is a remote file access protocol that forms the basis for Windows file sharing, network printing, and various other network services. CIFS requires a large number of request/response transactions and its performance degrades significantly over high-latency WAN links such as the Internet.

Note2: Network File System (NFS) is a network file system protocol, allowing a user on a client computer to access files over a network in a manner similar to how local storage is accessed. NFS, like many other protocols, builds on the Open Network Computing Remote Procedure Call (ONC RPC) system.

The screenshot shows a web-based form titled "Device Setting". It includes the following fields and controls:

- Device Type:** A dropdown menu with "CIFS" selected.
- Address:** A text input field.
- Remote directory:** A text input field.
- Capacity:** A text input field containing "0", followed by "GB".
- ID:** A text input field.
- Password:** A text input field.
- Check:** A button located at the bottom right of the form.

- * **Address:** Enter IP address for NAS device.
- * **Remote Directory:** Enter directory or folder location to be recorded in the NAS device.
- * **Capacity:** Enter the capacity of storage to be used. It must be less than the total storage capacity.
- * **IP/Password:** Enter ID and Password. The network camera will ask them whenever you access NAS device.
- * **Check:** Press the Check button to check the validity of Device Setting data.

- **Format**

Click the Format button to format SD card.

- **Device Information**

Show current SD card information.

▼ Event Notification

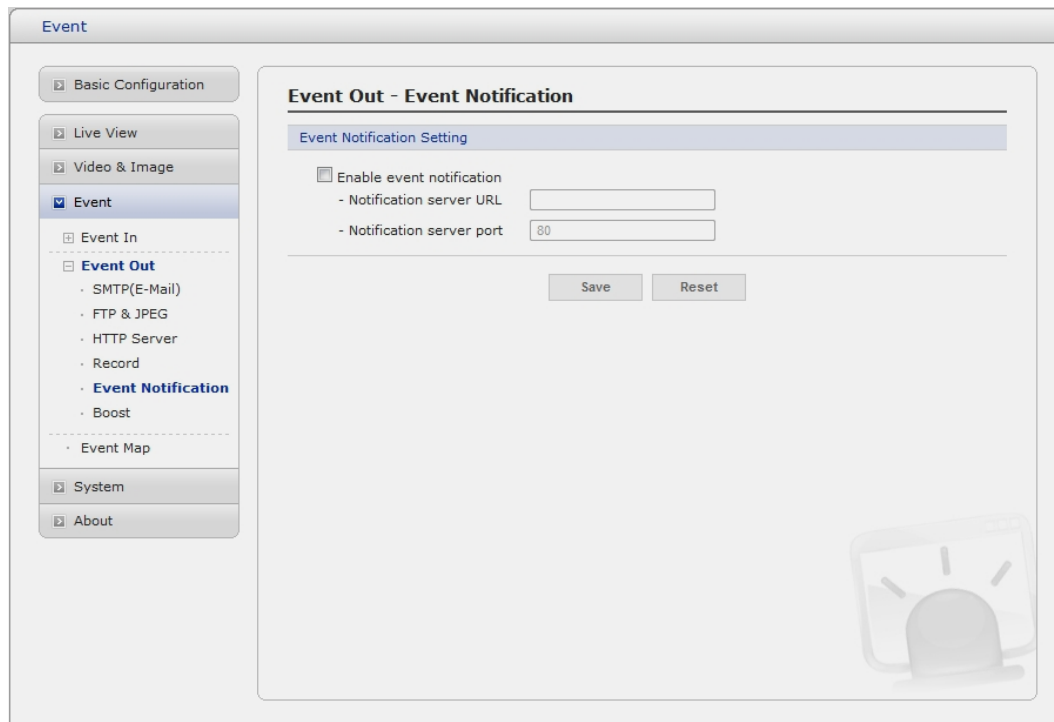

The screenshot shows a web interface for configuring event notifications. On the left is a navigation menu with categories: Basic Configuration, Live View, Video & Image, Event (selected), Event In, Event Out (expanded), System, and About. Under 'Event Out', 'Event Notification' is highlighted. The main area is titled 'Event Out - Event Notification' and contains an 'Event Notification Setting' section. It features a checkbox for 'Enable event notification', which is currently unchecked. Below it are two input fields: 'Notification server URL' (empty) and 'Notification server port' (containing '80'). At the bottom of the settings are 'Save' and 'Reset' buttons. A faint icon of a camera with a sunburst effect is visible in the bottom right corner of the main content area.

When the network camera detects an event, Notification Server is used to receive notification messages as a type of XML data format. Check the box to enable the service.

- **Event Notification Setting**
 - **Notification Server URL:** The network address to the server and the script that will handle the request.

▼ Boost

Event

Basic Configuration

Live View

Video & Image

Event

Event In

Event Out

- SMTP(E-Mail)
- FTP & JPEG
- HTTP Server
- Record
- Event Notification
- Boost**

Event Map

System

About

Event Out - Boost

Boost Setting

Enable boost

- Boost Stream: Stream 1

	Normal Condition	Boost Condition
Framerate	30	30
Bitrate control	CBR	
Bitrate	4000 [Kbps]	4000 [Kbps]

Save Reset

The Boost feature is used in conjunction with event detection. When this feature is turned ON, the Framerate and Bitrate in the boost condition can be set to a different value than the ones in the normal condition field. When an event is detected, the camera will boost the Framerate and Bitrate from the normal condition to this boosted level for the duration of the event.

Check the box to enable the service.

- **Boost Setting**

You can set the condition in Normal and Boost mode.

- **Boost Stream:** Select a video stream for each condition in the drop-down list.
- **Framerate:** Select a frame refresh rate per second for each condition in the drop-down list.
- **Bitrate control:** Select VBR or CBR in the drop-down list in Normal Condition. You can't change it in Boost Condition.
- **Bitrate:** Select a value for each condition in the drop-down list.

3) Event Map

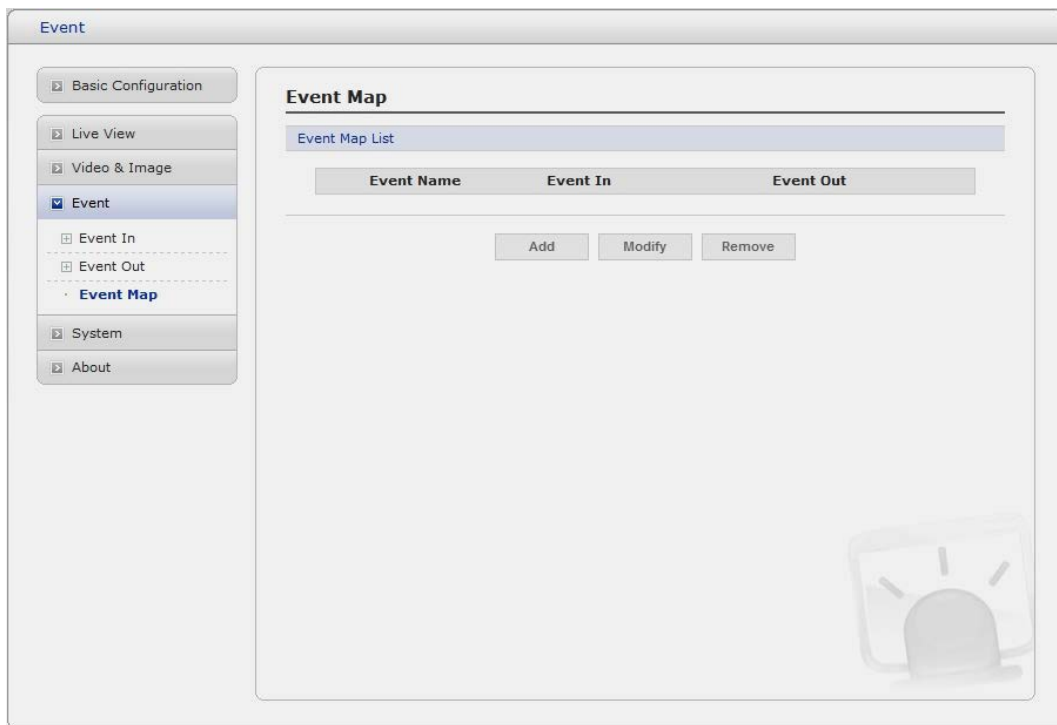

The event map allows you to change the settings and establish a schedule for each event trigger from the Network Camera. You can register the event map up to max. 15.

Click Add button to make a new event map and you can see a popup window as below.

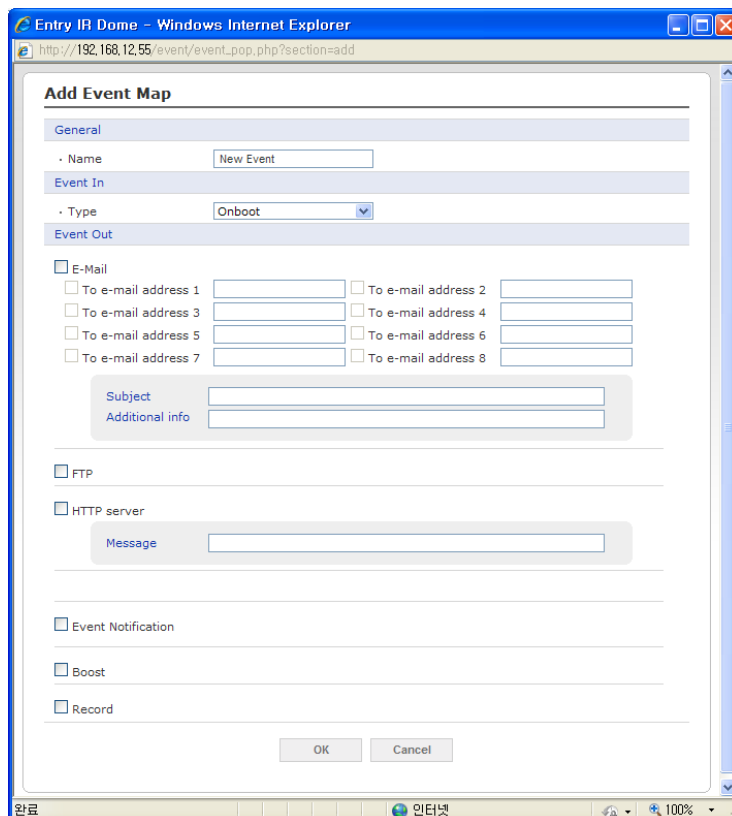

- **General**
Enter the name for a new event map.

- **Event In**
Select an event type in the drop down list.

- **Event Out**
 - **E-mail:** Select email addresses you want to send via email that an event has occurred.
 - **FTP:** Select checkbox beside FTP to record and saves images to an FTP server when an event has occurred.
 - **HTTP Server:** It sends notification messages to an HTTP server that listens for these. The destination server must first be configured on the Event In page. Enter a message you want to send.
 - **Event Notification:** It sends XML messages to an Notification server that listens for these. The destination server must first be configured on the Event In page.
 - **Boost:** when an event has occurred, the camera will boost the Framerate and Bitrate from the normal condition to this boosted level for the duration of the event. Check the box to enable the Function.
 - **Record:** When the network camera detects an event, it can record video stream in the Micro SD Memory (not supplied) or NAS (Network Attached Device) as a storage device. Check the box to enable the Function.

3.5.5 System

1) Information

You can enter the system information. This page is very useful when you refer device information after installation.

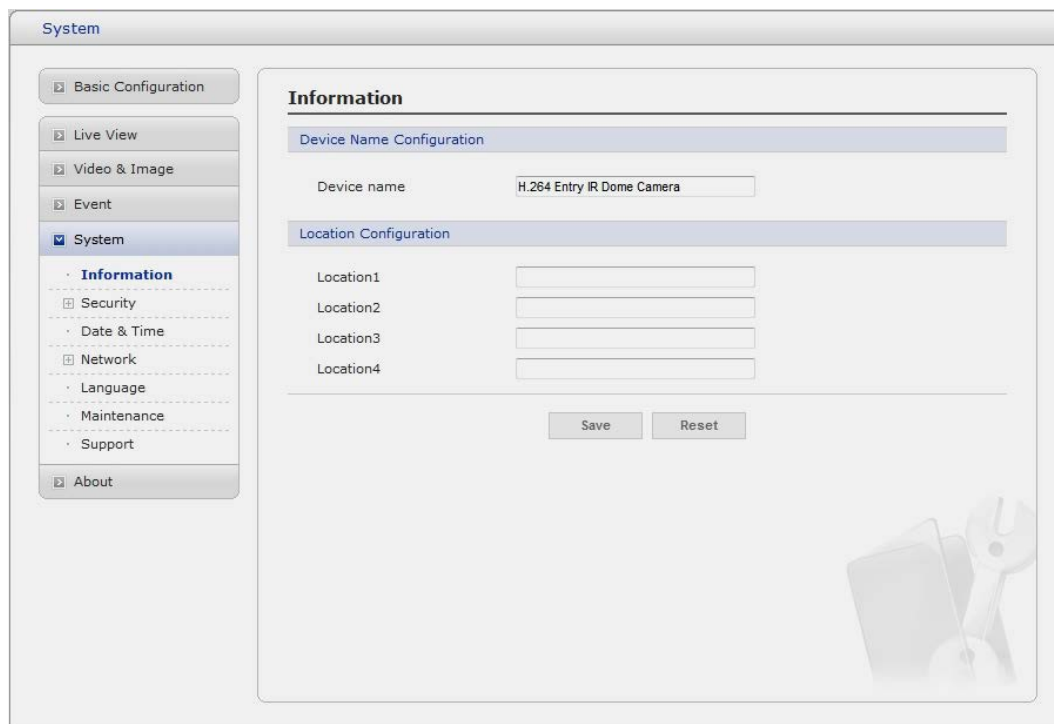

The screenshot shows a web interface for system configuration. On the left is a sidebar menu with the following items: Basic Configuration, Live View, Video & Image, Event, System (selected), Information (sub-menu), Security, Date & Time, Network, Language, Maintenance, Support, and About. The main content area is titled 'System' and contains an 'Information' section. This section has two sub-sections: 'Device Name Configuration' with a text input field containing 'H.264 Entry IR Dome Camera', and 'Location Configuration' with four text input fields labeled 'Location1', 'Location2', 'Location3', and 'Location4'. At the bottom of the main area are 'Save' and 'Reset' buttons. A faint watermark of a camera and tools is visible in the bottom right corner of the interface.

- **Device Name Configuration**
Enter the device name.
- **Location Configuration**
Enter the location information. You can enter that by four.

2) Security

▼ Users

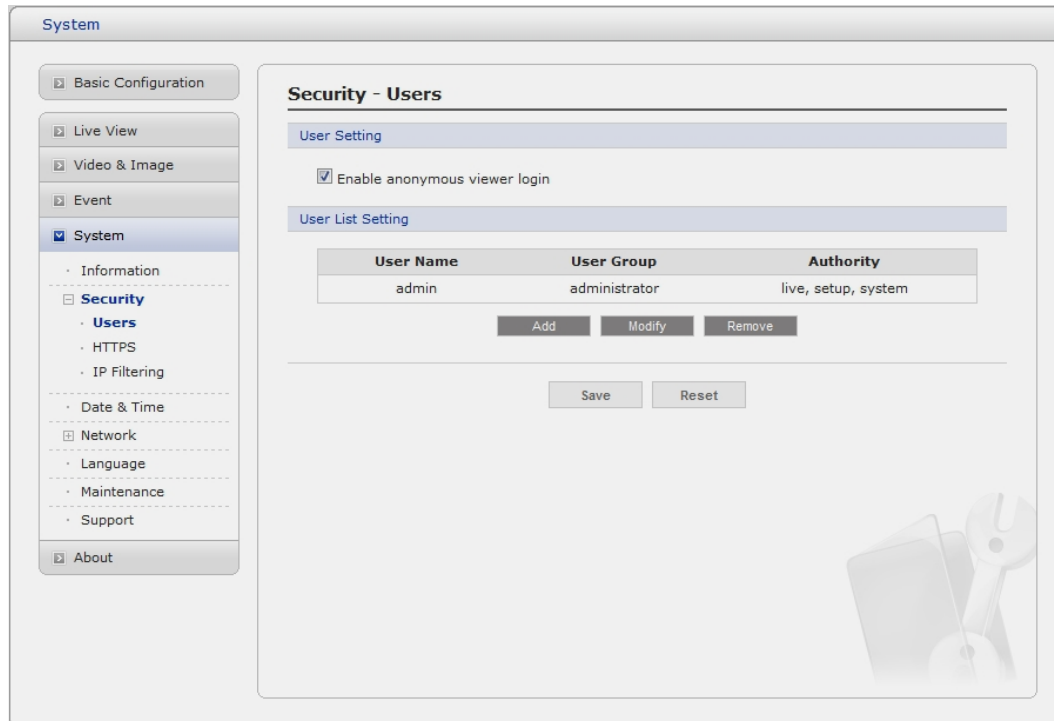

User access control is enabled by default, when the administrator sets the root password on first access. New users are authorized with user names and passwords, or the administrator can choose to allow anonymous viewer login to the Live View page, as described below:

- **User Setting**
Check the box to enable anonymous viewer login to the Network Camera without the user account. When using the user account, users have to try log-in at every access.
- **User List Setting**
This section shows a registered user account. Enter a user name and password to be added, and register them by pressing the Add button. You can see the pop-up window as below.



▼ HTTPS

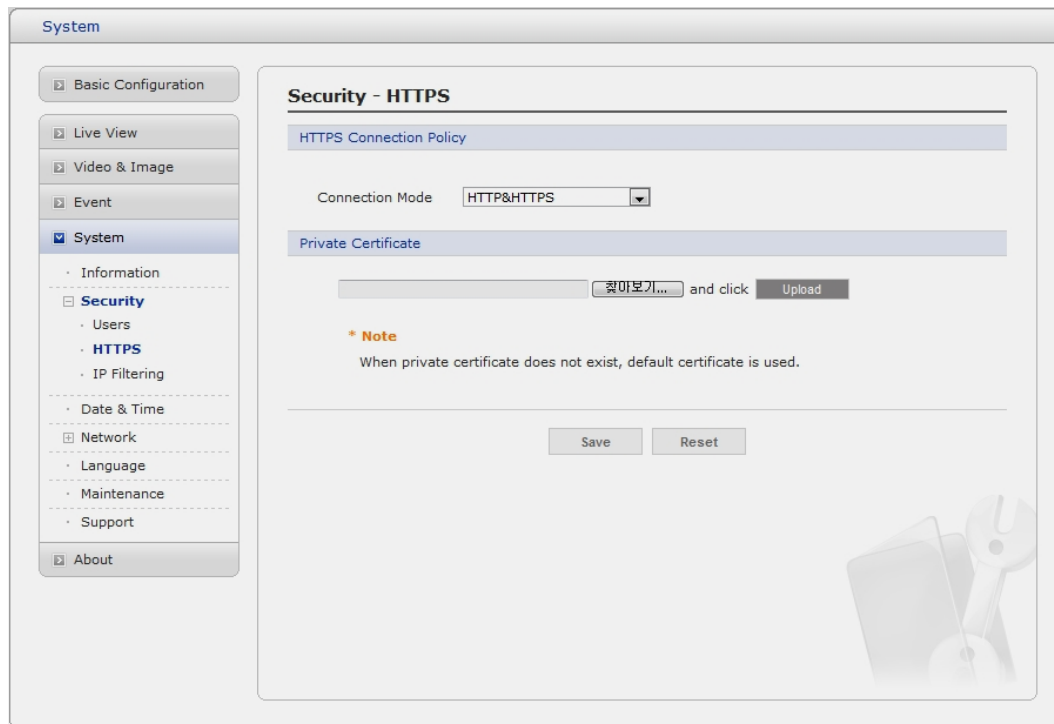

For greater security, the Network Camera can be configured to use HTTPS (Hypertext Transfer Protocol over SSL (Secure Socket Layer)). That is, all communication that would otherwise go via HTTP will instead go via an encrypted HTTPS connection.

- **HTTPS Connection Policy**
Choose the form of connection you wish to use from the drop-down list for the administrator, Operator and Viewer to enable HTTPS connection (set to HTTP by default).
 - HTTP
 - HTTPS
 - HTTP & HTTPS
- **Upload Certificate**
To use HTTPS for communication with the Network Camera, An official certificate issued by a CA (Certificate Authority) must be uploaded from your PC. Provide the path to the certificate directly, or use the **Browse** button to locate it. Then click the **Upload** button.

Please refer to the home page of your preferred CA for information on where to send the request. For more information, please see the online help.

▼ IP Filtering

System

Basic Configuration

Live View

Video & Image

Event

System

- Information
- Security
 - Users
 - HTTPS
 - IP Filtering
- Date & Time
- Network
- Language
- Maintenance
- Support

About

Security - IP Filtering

IP Filtering Setting

Enable IP filtering

On/Off	Priority	Policy	Start IP	End IP
<input type="checkbox"/>	1	ALLOW	0 . 0 . 0 . 0	0 . 0 . 0 . 0
<input type="checkbox"/>	2	ALLOW	0 . 0 . 0 . 0	0 . 0 . 0 . 0
<input type="checkbox"/>	3	ALLOW	0 . 0 . 0 . 0	0 . 0 . 0 . 0
<input type="checkbox"/>	4	ALLOW	0 . 0 . 0 . 0	0 . 0 . 0 . 0
<input type="checkbox"/>	5	ALLOW	0 . 0 . 0 . 0	0 . 0 . 0 . 0

Save Reset

Checking the **Enable IP address filtering** box enables the IP address filtering function. Up to 256 IP address entries may be specified (a single entry can contain multiple IP addresses). Click the **Add** button to add new filtered addresses.

When the IP address filter is enabled, addresses added to the list are set as allowed **or** denied addresses. All other IP addresses not in this list will then be allowed or denied access accordingly, that is, if the addresses in the list are allowed, then all others are denied access, and vice versa. See also the online help for more information.

Note that users from IP addresses that will be allowed must also be registered with the appropriate access rights (Guest, Operator or Administrator). This is done from Setup> System>Security>Users.

3) Date & Time

The screenshot shows a web-based configuration interface for a system. On the left is a navigation menu with categories: Basic Configuration, Live View, Video & Image, Event, System (selected), Information, Security, Date & Time (highlighted), Network, Language, Maintenance, Support, and About. The main content area is titled 'Date & Time' and is divided into three sections: 'Current Server Time', 'New Server Time', and 'Date & Time Format'. The 'Current Server Time' section shows 'Date : 2013-10-29' and 'Time : 15:08:01'. The 'New Server Time' section includes a 'Time zone' dropdown set to '(GMT) Greenwich Mean Time : Dublin, Edinburgh, Lisbon, London' and a checkbox for 'Automatically adjusts for daylight saving time changes'. The 'Time mode' section has three radio buttons: 'Synchronize with computer time' (selected), 'Synchronize with NTP server' (with 'NTP server : time.nist.gov' and 'NTP Interval : 12 [hour]'), and 'Set manually'. Below this, the 'Date & Time Format' section has dropdowns for 'Date Format : YYYY-MM-DD' and 'Time Format : 24 Hour'. At the bottom are 'Save' and 'Reset' buttons.

- **Current Server Time**
It displays the current date and time (24h clock). The time can be displayed in 12h clock format in the overlay (see below).
- **New Server Time**
Select your time zone from the drop-down list. If you want the server clock to automatically adjust for daylight savings time, select "Automatically adjustment for daylight saving time changes".

From the Time Mode section, select the preferred method to use for setting the time:

- **Synchronize with computer time:** sets the time from the clock on your computer.
- **Synchronize with NTP Server:** the network camera will obtain the time from an NTP server every 60 minutes.
- **Set manually:** this option allows you to manually set the time and date.

Note: Note that if using a host name for the NTP server, a DNS server must be configured under TCP/IP settings.

4) Network

The screenshot displays a web-based network configuration interface. On the left is a sidebar menu with categories: Basic Configuration, Live View, Video & Image, Event, System (selected), Information, Security, Date & Time, Network (expanded), Basic (selected), DDNS, RTP, UPnP, QoS, NAT, Zeroconf, Bonjour, Live Push, Language, Maintenance, Support, and About. The main content area is titled 'Network - Basic' and contains several sections: 'IP Address Configuration' with radio buttons for DHCP and static IP (selected), and input fields for IP address (192.168.30.220), Subnet mask (255.255.255.0), and Default router (192.168.30.1); 'IPv6 Address Configuration' with an unchecked 'Enable IPv6' checkbox and an IPv6 address field (fe80::207:d8ff:fe00:f1db/64); 'DNS Configuration' with radio buttons for DHCP and static DNS server (selected), and input fields for Domain name, Primary DNS server (168.126.63.1), and Secondary DNS server (0.0.0.0); 'Host Name Configuration' with a Host Name field (NVT-8224R0007D800F1DB); 'Services' with input fields for HTTP port (80), HTTPS port (443), and RTSP port (554); and 'ARP/Ping setting' with a checked 'Enable ARP/Ping setting' checkbox. At the bottom right are 'Save' and 'Reset' buttons.

Setting in regard to network can be executed. Settings for IP, DNS, Host Name, Port, and ARP/Ping can be established, along with setting for DDNS, uPnP, QoS, Zeroconfig, Bonjour and wireless.

▼ Basic

- **IP Address Configuration:**
 - **Obtain IP address via DHCP:** Dynamic Host Configuration Protocol (DHCP) is a protocol that lets network administrators centrally manage and automate the assignment of IP addresses on a network. DHCP is enabled by default. Although a DHCP server is mostly used to set an IP address dynamically, it is also possible to use it to set a static, known IP address for a particular MAC address.
 - **Use the following IP address:** To use a static IP address for the Network Camera, check the radio button and then make the following settings:
 - * **IP address:** Specify a unique IP address for your Network Camera.
 - * **Subnet mask:** Specify the mask for the subnet the Network Camera is located on.
 - * **Default router:** Specify the IP address of the default router (gateway) used for connecting devices attached to different networks and network segments.
- **IPv6 Address Configuration**

Check this box to enable IPv6. Other settings for IPv6 are configured in the network router.
- **DNS Configuration**

DNS (Domain Name Service) provides the translation of host names to IP addresses on your network.

 - **Obtain DNS Server via DHCP:** Automatically use the DNS server settings provided by the DHCP server. Click the View button to see the current settings.
 - Use the following DNS server address to enter the desired DNS server by specifying the following:
 - * **Domain name:** enter the domain(s) to search for the host name used by the Network Camera. Multiple domains can be separated by semicolons (;). The host name is always the first part of a Fully Qualified Domain Name, for example, my server is the host name in the Fully Qualified Domain Name myserver.mycompany.com where mycompany.com is the Domain name.
 - * **DNS servers:** enter the IP addresses of the primary and secondary DNS servers.
- **Host Name Configuration**
 - **Host Name:** enter the host name to be used as device information in the client software or Speco Manager.
- **Services**
 - **HTTP port:** Enter a port to receive a service through the HTTP. Default Port Number is '80'.
 - **HTTPS port:** Enter a port to receive a service through the HTTPS. Default Port Number is '443'.
 - **RTSP port:** Enter a port to receive a service through the RTSP. Default Port Number is '554'.
- **ARP/Ping Setting**
 - Enable ARP/Ping setting of IP address - The IP address can be set using the ARP/Ping method, which associates the unit's MAC address with an IP address. Check this box to enable the service.
Leave disabled to prevent unintentional resetting of the IP address.
- **Gateway Priority**
 - **Wireless:** In case of network connection through the wireless AP
 - **Wire:** In case of a wired network connection.

▼ DDNS

The screenshot shows a web interface for configuring DDNS. On the left is a navigation menu with categories like System, Security, Network, and About. The 'System' category is selected, and the 'Network - DDNS' sub-menu is active. The main content area is titled 'Network - DDNS' and contains the following elements:

- Internet DDNS (Dynamic Domain Name Service)**
- Enable DDNS
- * Note**
Please remember you have to configure at least primary DNS server in DNS configuration settings to use Dynamic DNS.
- DDNS Server:
- Registered host:
- User name:
- Password:
- Confirm password:
- Maximum time interval:
- Register local network IP address
- Registered IP address : _____
- Buttons: Save, Reset

- **Internet DDNS(Dynamic Domain Name Service)**

When using the high-speed Internet with the telephone or cable network, users can operate the Network Camera even on the floating IP environment in which IPs are changed at every access. Users should receive an account and password by visiting a DDNS service like <http://www.dyndns.com/>, or <http://www.cctv-network.co.kr/>.

- **Enable DDNS:** Check to get DDNS service to be available.
 - * **Username:** Enter an ID to access to the DDNS server.

▼ RTP

System

Basic Configuration

Live View

Video & Image

Event

System

- Information
- Security
- Date & Time
- Network**
 - Basic
 - DDNS
 - RTP**
 - UPnP
 - QoS
 - NAT
 - Zeroconf
 - Bonjour
 - Live Push
- Language
- Maintenance
- Support

About

Network - RTP

Port Range

Start port: [30000... 39920; only even values are available]

End port:

Multicast (Stream 1)

- Multicast destination IP: [224.0.0.0... 239.255.255.255]

- RTP port: [1024... 65530]

- RTP TTL: [1... 255]

Always enable multicast

Multicast (Stream 2)

- Multicast destination IP: [224.0.0.0... 239.255.255.255]

- RTP port: [1024... 65530]

- RTP TTL: [1... 255]

Always enable multicast

Multicast (Stream 3)

- Multicast destination IP: [224.0.0.0... 239.255.255.255]

- RTP port: [1024... 65530]

- RTP TTL: [1... 255]

Always enable multicast

Multicast (Meta)

- Multicast destination IP: [224.0.0.0... 239.255.255.255]

- RTP port: [1024... 65530]

- RTP TTL: [1... 255]

Always enable multicast

Save Reset

Have a setting for sending and receiving a video on a real-time basis. These settings are the IP address, port number, and Time-To-Live value to use for the media stream(s) in multicast H.264 format. Only certain IP addresses and port numbers should be used for multicast streams. For more information, please see the online help.

- **Port Range**
 - **Start port:** Enter a value between 30000 and 39920
 - **End port:** Enter a value between 30000 and 39920
- **Multicast(Stream1/Stream2/Stream3)**

This function is for sending Video to Multicast group.

 - **Enable Multicast:** Check the checkbox to enable multicast operation.

- **Multicast destination IP:** Enter an IP between 224.0.0.0 and 239.255.255.255. Although it is empty, an IP will be entered automatically.
- **RTP port:** Enter a value between 1024 and 65530.
- **RTP TTL:** Enter a value between 1 and 255. If a network status is smooth, enter a lower value. On the other hand, if a network status is poor, enter a higher value. When there are many Network Cameras or users, a higher value may cause a heavy load to the network. For a detailed setting, please consult with a network manager.

▼ UPnP

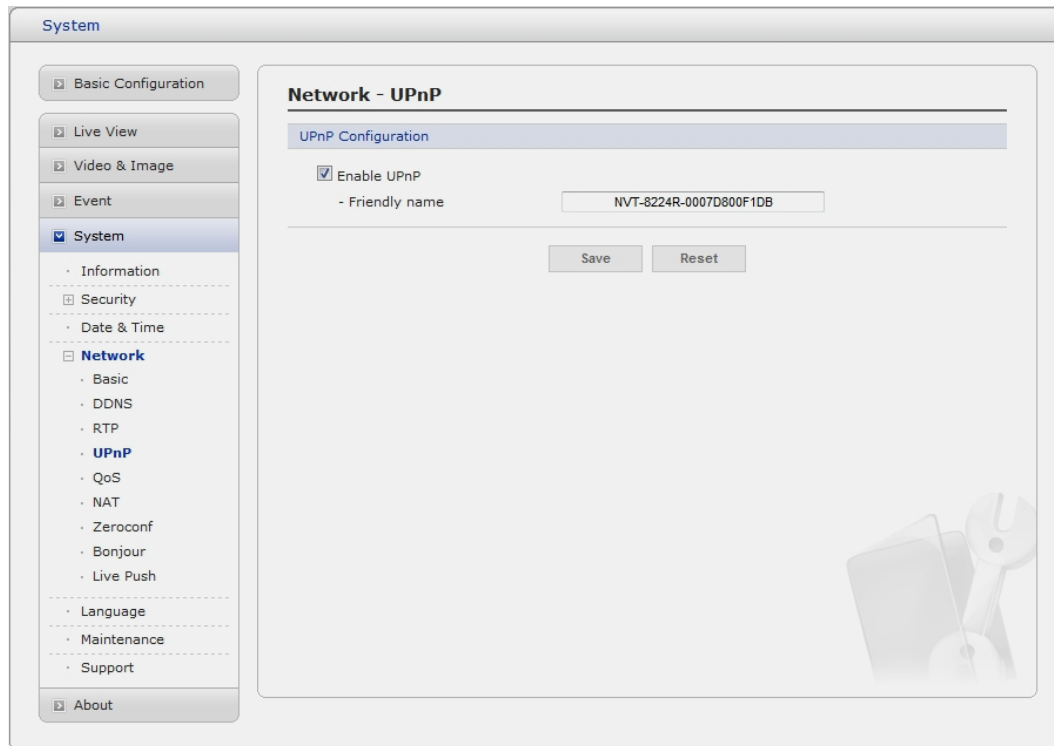

The Network Camera includes support for UPnP™. UPnP™ is enabled by default, and the Network Camera then is automatically detected by operating systems and clients that support this protocol.

Note: UPnP™ must be installed on your workstation if running Windows XP. To do this, open the Control Panel from the Start Menu and select Add/Remove Programs. Select Add/Remove Windows Components and open the Networking Services section. Click Details and then select UPnP™ as the service to add.

▼ QoS

Quality of Service (QoS) provides the means to guarantee a certain level of a specified resource to selected traffic on a network. Quality can be defined as a maintained level of bandwidth, low latency, and no packet losses.

The main benefits of a QoS-aware network are:

- The ability to prioritize traffic and thus allow critical flows to be served before flows with lesser priority.
- Greater reliability in the network, thanks to the control of the amount of bandwidth an application may use, and thus control over bandwidth races between applications.

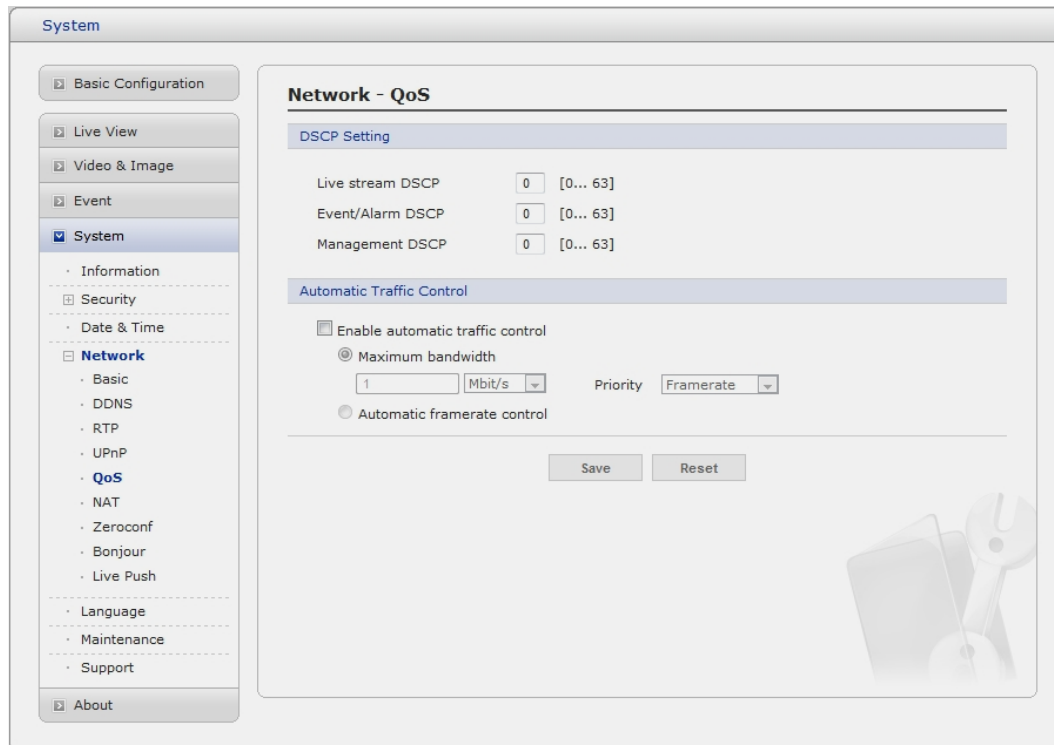

- **DSCP Settings**

For each type of network traffic supported by your network video product, enter a DSCP (Differentiated Services Code Point) value. This value is used to mark the traffic's IP header. When the marked traffic reaches a network router or switch, the DSCP value in the IP header tell the router or switch which type of treatment to apply to this type of traffic, for example, how much bandwidth to reserve for it. Note that DSCP values can be entered in decimal or hex form, but saved values are always shown in decimal.

The following types of traffic are marked:

- **Live Stream DSCP:**
- **Event/Alarm DSCP:**
- **Management DSCP:**

- **Automatic Traffic Control**

Set a limitation on user network resources by designating the maximum bandwidth.

- **Maximum bandwidth:** In case of sharing other network programs or equipment, it is possible to set a limitation on the maximum bandwidth in the unit of Mbit/s or kbit/s.
- **Auto frame rate:** Selected if not influenced by a network-related program or equipment without a limitation on the network bandwidth.

▼ NAT Traversal

A broadband router allows devices on a private network (LAN) to share a single connection to the Internet. This is done by forwarding network traffic from the private network to the “outside”, that is, the Internet. Security on the private network (LAN) is increased since most broadband routers are pre-configured to stop attempts to access the private network (LAN) from the public network/Internet.

Use **NAT traversal** when your network cameras are located on an intranet (LAN) and you wish to make it available from the other (WAN) side of a NAT router. With NAT traversal properly configured, all HTTP traffic to an external HTTP port in the NAT router is forwarded to the network camera.

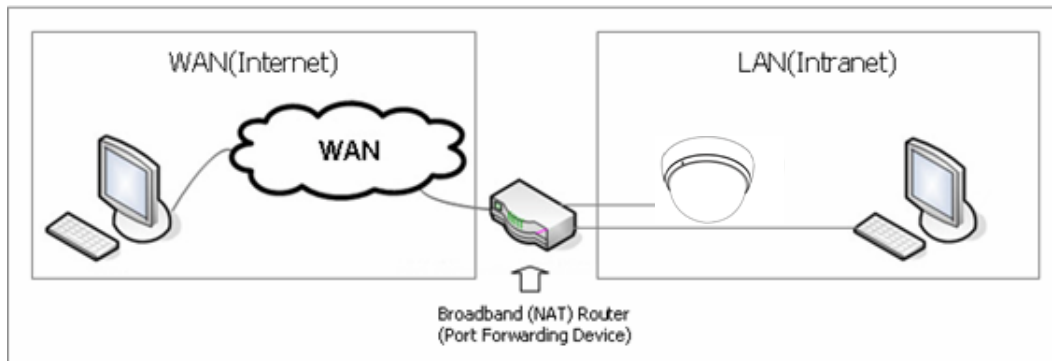

Notes:

- For NAT traversal to work, this must be supported by the broadband router.
- The broadband router has many different names: “NAT router”, “Network router”, “Internet Gateway”, “Broadband sharing device” or “Home firewall” but the essential purpose of the device is the same.

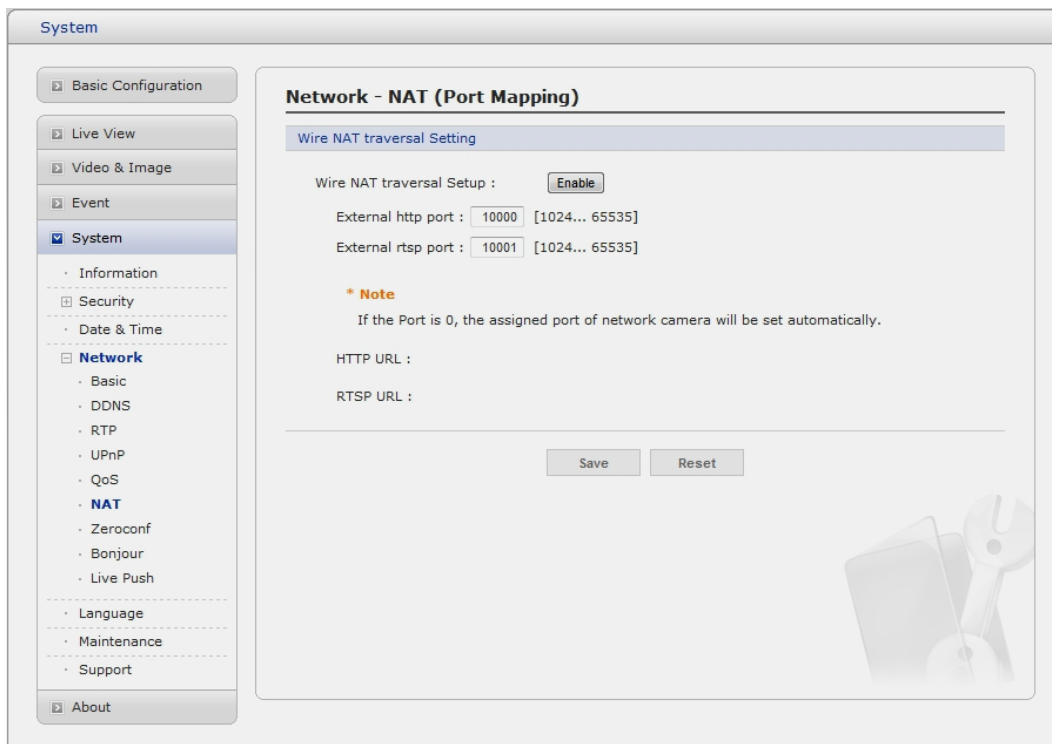

- **NAT traversal Settings**

- **Enable:** when enabled, the network camera attempt to configure port mapping in a NAT router on your network, using UPnP™. Note that UPnP™ must be enabled in the Network Camera (see System>Network>UPnP).
- * **automatic setting:** The Network Camera automatically search for NAT routers on your network.
- * **manual setting:** Select this option to manually select a NAT router and enter the external port number for the router in the field provided.

Notes:

- If you attempt to manually enter a port that is already in use, an alert message will be displayed.
- When the port is selected automatically it is displayed in this field. To change this enter a new port number and click Save.

▼ **Zeroconfig**

Zeroconfig allows the network camera to create and assign IP address for network cameras and connect to a network automatically.

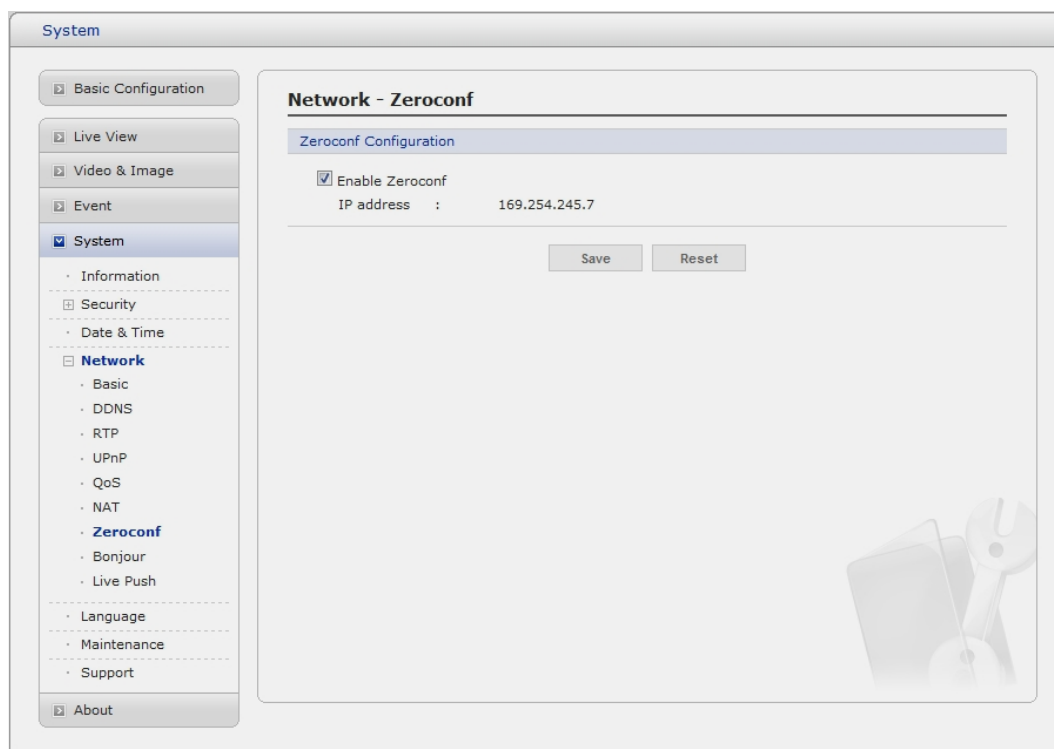

Zero configuration networking (zeroconf), is a set of techniques that automatically creates a usable Internet Protocol (IP) network without manual operator intervention or special configuration servers.

Zero configuration networking allows devices such as computers and printers to connect to a network automatically. Without zeroconf, a network administrator must set up services, such as Dynamic Host Configuration Protocol (DHCP) and Domain Name System (DNS), or configure each computer's network settings manually, which may be difficult and time-consuming.

Zeroconf is built on three core technologies:

- Assignment of numeric network addresses for networked devices (link-local address auto configuration)
- Automatic resolution and distribution of computer hostnames (multicast DNS)
- Automatic location of network services, such as printing devices through DNS service discovery.

▼ Bonjour

The network camera includes support for Bonjour. When enabled, the network camera is automatically detected by operating systems and clients that support this protocol.

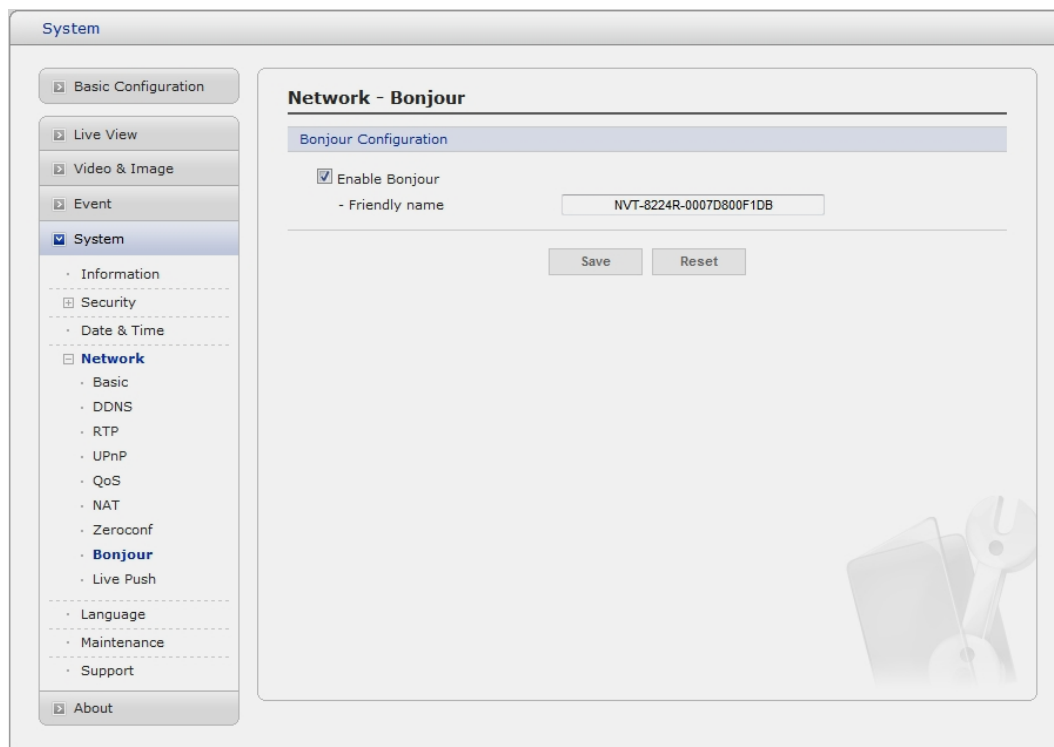

Note: Bonjour - Also known as zero-configuration networking, Bonjour enables devices to automatically discover each other on a network, without having to enter IP addresses or configure DNS servers. Bonjour is a trademark of Apple Computer, Inc.

▼ Live Push

The screenshot displays the 'System' configuration page with a sidebar on the left. The sidebar includes sections for 'Basic Configuration', 'Live View', 'Video & Image', 'Event', 'System' (selected), 'Information', 'Security', 'Date & Time', 'Network' (expanded), 'Language', 'Maintenance', 'Support', and 'About'. Under 'Network', 'Live Push' is highlighted. The main content area is titled 'Network - Live Push' and contains three identical configuration sections: 'Live Push 1 Configuration', 'Live Push 2 Configuration', and 'Live Push 3 Configuration'. Each section has a checkbox for 'Enable live push' and four input fields: 'URL', 'Port' (with '80' pre-filled), 'User name', and 'Password'. At the bottom of the configuration area are 'Save' and 'Reset' buttons. A faint watermark of a laptop and tools is visible in the bottom right corner of the interface.

When you activate this function, the network camera as a client can transfer audio, video and event data to the registered server. The network camera and server use RTP/RTSP as the protocol for the actual transport of audio/video data.

Up to 3 servers can be configured.

- **URL:** The network address to the server and the script that will handle the request.
- **Port:** Enter the port number used by the Live Push server. The default is 80.
- **User name/Password:** Provide your log-in information. The network camera will ask them whenever you access the Live Push Server.

5) Language

It will be able to select a user language. The type of language it will be able to select is the English, chinese, Russian and the Korean.

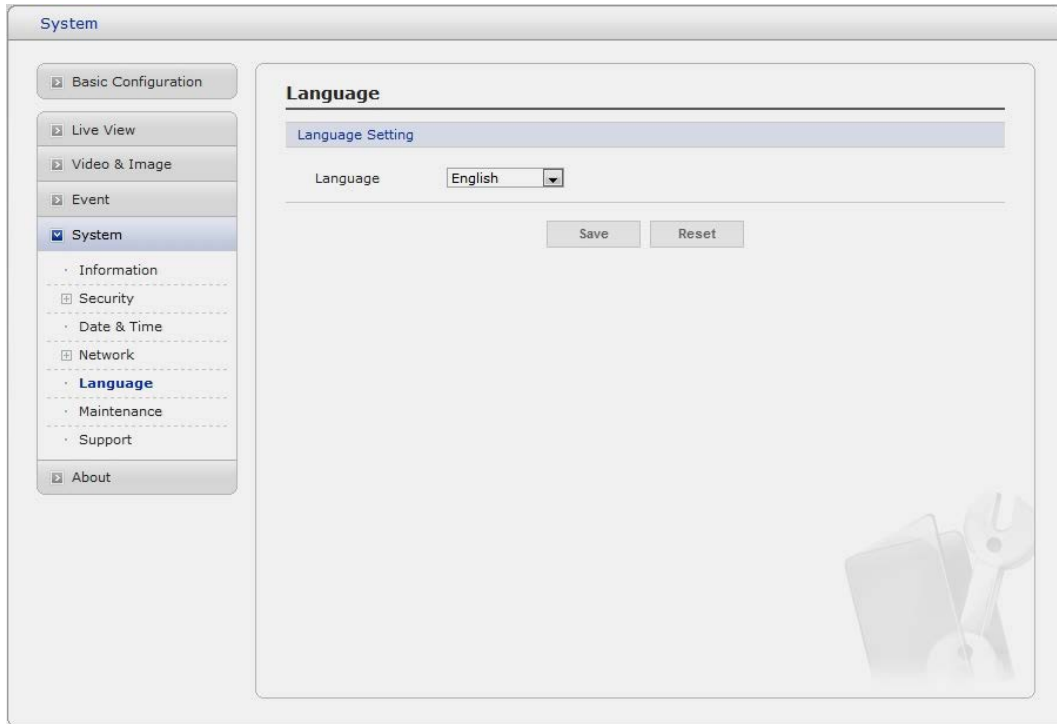

6) Maintenance

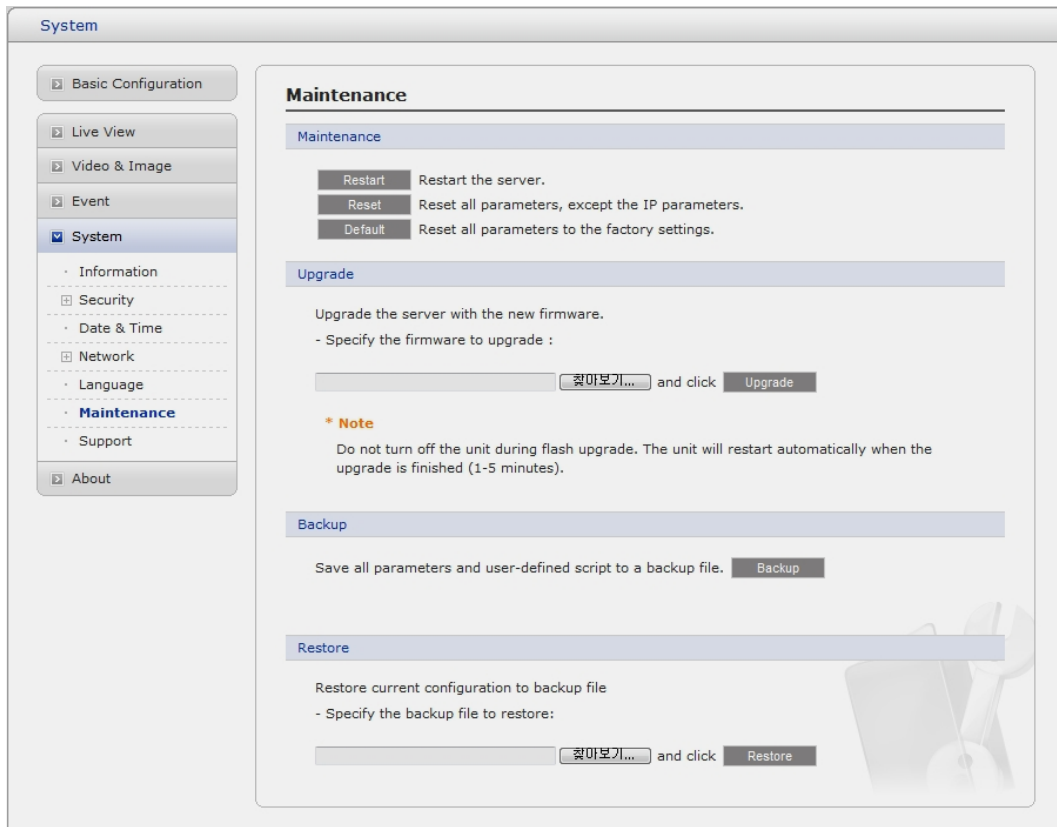

- **Maintenance**

- **Restart:** The unit is restarted without changing any of the settings. Use this method if the unit is not behaving as expected.
- **Reset:** The unit is restarted and most current settings are reset to factory default values. The settings that are not affected are:
 - * the boot protocol (DHCP or static)
 - * the static IP address
 - * the default router
 - * the subnet mask
 - * the system time
- **Default:** The default button should be used with caution. Pressing this will return all of the Network Camera's settings to the factory default values (including the IP address).

- **Upgrade**

Carry out the upgrade by importing an upgrade file and pressing the Upgrade button. During the upgrade, do not turn off the power of the Network Camera. And try an access again after waiting five minutes or longer.

- **Backup**

Save a setting value that users enter to the Network Camera, to a user PC.

- **Restore**

Import and apply a setting value saved to a user PC.

Note: Backup and Restore can only be used on the same unit running the same firmware. This feature is not intended for multi-configurations or for firmware upgrades.

7) Support

The support page provides valuable information on troubleshooting and contact information, should you require technical assistance.

System

- Basic Configuration
- Live View
- Video & Image
- Event
- System**
 - Information
 - Security
 - Date & Time
 - Network
 - Language
 - Maintenance
 - Support**
- About

Support

The log and report files can be useful for troubleshooting or contacting the support team.

Logs

- System Log System log information
- Event Log Event log information

Reports

- Server Report Important information of the server status.
- Parameter List The unit's parameters and their current settings.

Health Check

- System Check Important information of system resources.
- Media Check Video and audio stream information.
- Network Check Network setting and traffic information.
- Hardware Check Hardware diagnostic check.

- **Logs**
The network Camera support system log information. Click the System Log button to get the log data.
- **Reports**
 - **Server Report:** Click the Server Report button to get the important information about the server's status and should always be included when requesting support.
 - **Parameter List:** Click the Parameter List button to see the unit's parameters and their current settings.
- **Health Check**
 - **System Check:** Click the System Check button to get the important information about the camera's system resources. You can see the pop-up window below.

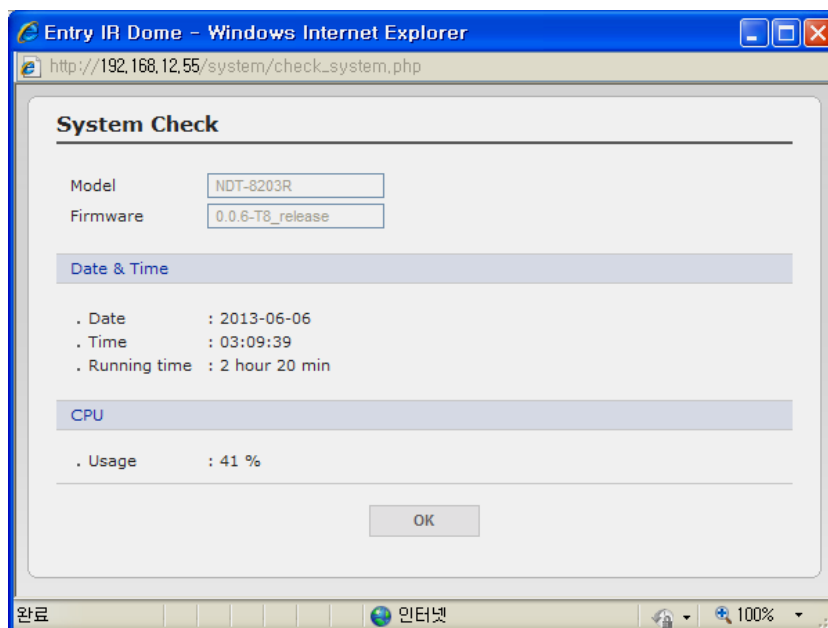

- **Media Check:** Click the Media Check button to get the information about the camera's video stream. You can see the pop-up window below.

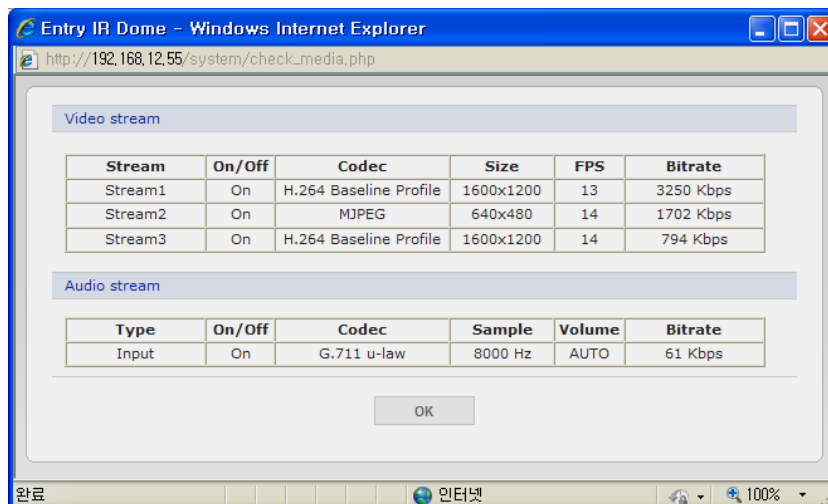

- **Networks Check:** Click the Network Check button to get the information about the camera's network setting and traffic. You can see the pop-up window below.

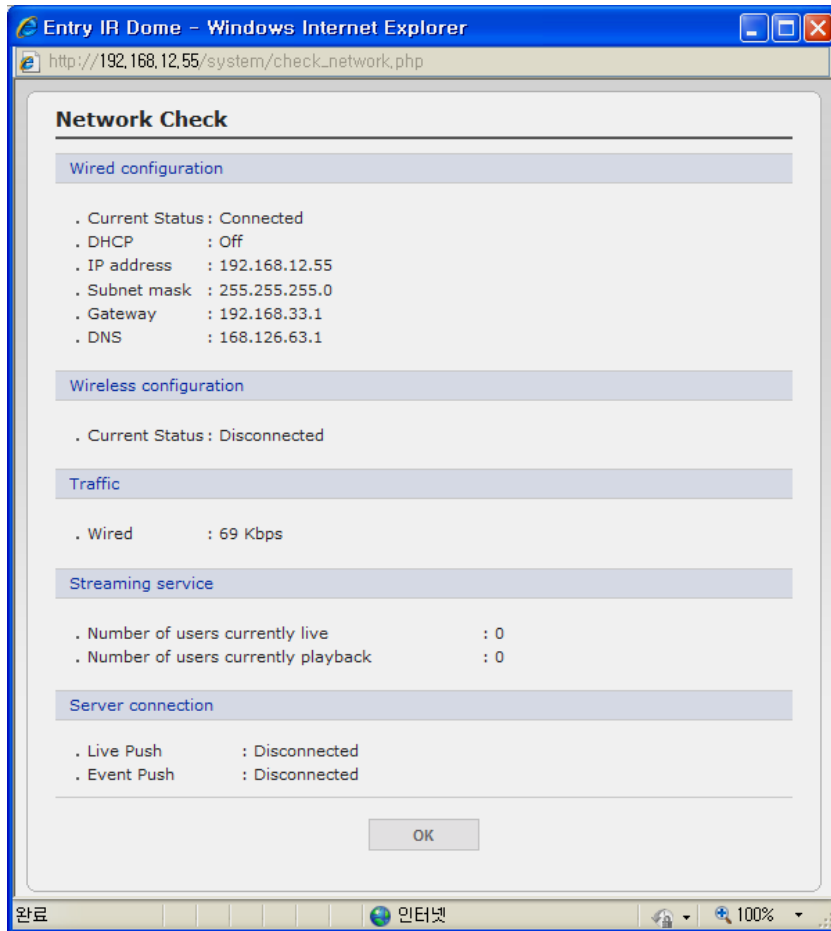

- **Hardware Check:** Click the Hardware Check button to diagnose the camera's hardware like video.

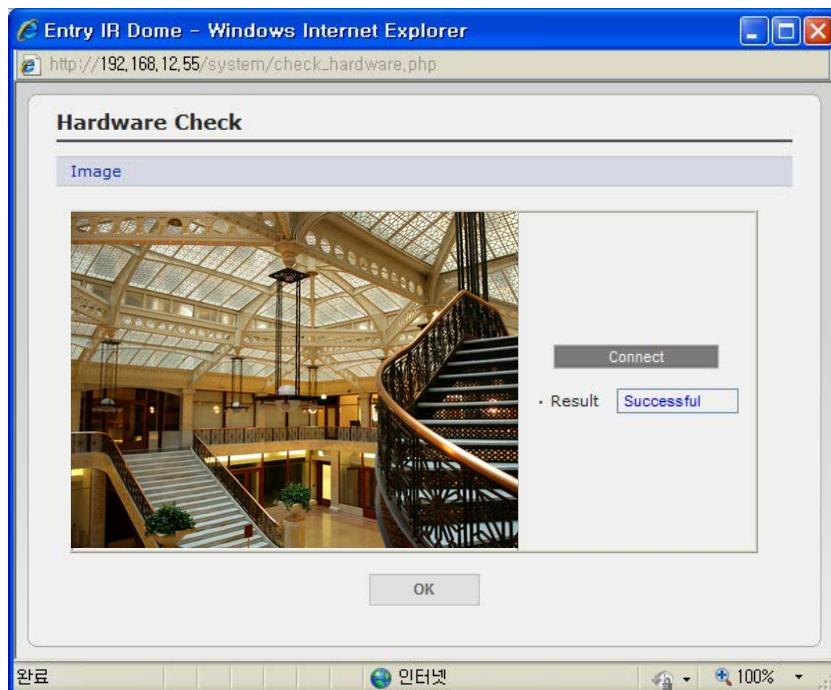

3.5.6 About

The following website will provide the support information for the Network Camera information and operation.

3.6 Playback

The Playback window contains a list of recordings made to the memory card. It shows each recording's start time, length, the event type used to start the recording, calendar and time slice bar indicates if the recording is existed or not.

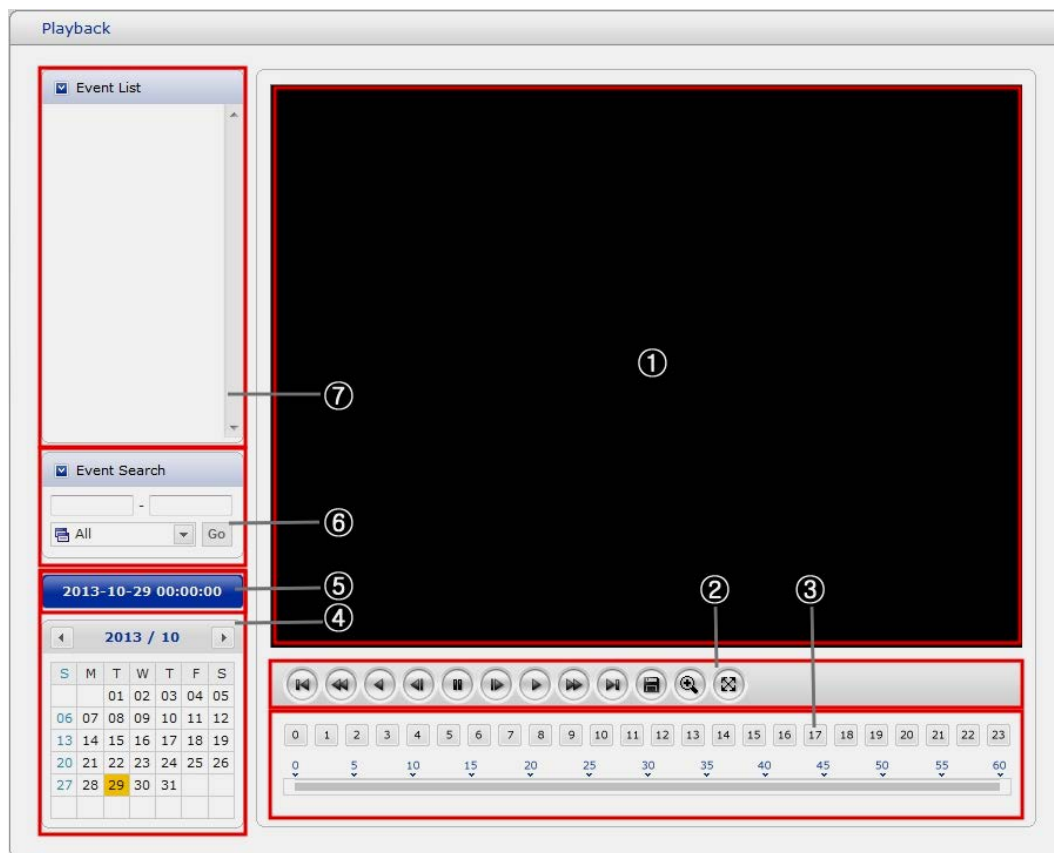



The description of playback window follows.











(1) Video Screen

You can see the video screen when playing the video clip in the Micro SD memory

(2) Playback Buttons

To view a recording data in the SD local storage, select it from the list and click the Playback buttons.

-  Go to the first: go to the beginning of the video clip.
-  Fast backward play:

-  Backward play: play backward of the video clip.
-  Step backward play: go back one frame of the video clip.
-  Pause: pause playback of the video clip.
-  Step forward play: go forward one frame of the video clip.
-  Forward Play: play forward the video clip.
-  Fast forward play: play fast forward of the video clip.
-  Step forward play: go forward one frame of the video clip.
-  Clip copy: copy the video clip.
-  Zoom In: zoom in the video clip
-  Full Screen: display full screen of the video.

(3) Time Chart

Display an hour-based search screen for the chosen date. If there is recording data, a blue section will be displayed on a 24-hour basis.

(4) Search Calendar

Search results from the SD local storage in the network camera connected are displayed monthly. If there is a recorded data for a particular date, a blue square on the date will be displayed.

(5) Play Time

Displays time of the video playing.

(6) Event Search Window

Select a search option in the drop-down list and click GO button. You can also enter the time period for searching. If you click Start Date or End Date zone, displays Search Calendar.

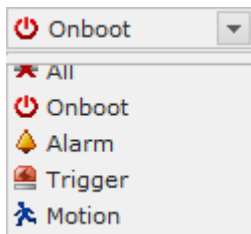

(7) Event List Window

Event List displays the event(s) that were recorded in the SD local storage. Select a list and click the play button. The video clip will be played.

3.7 Help

The Help information window will be provided as a popup window so that users can open and read it without a need for log-in. It will offer a description on setting and Help page by which users can manipulate the Network Camera without a reference to the manual.

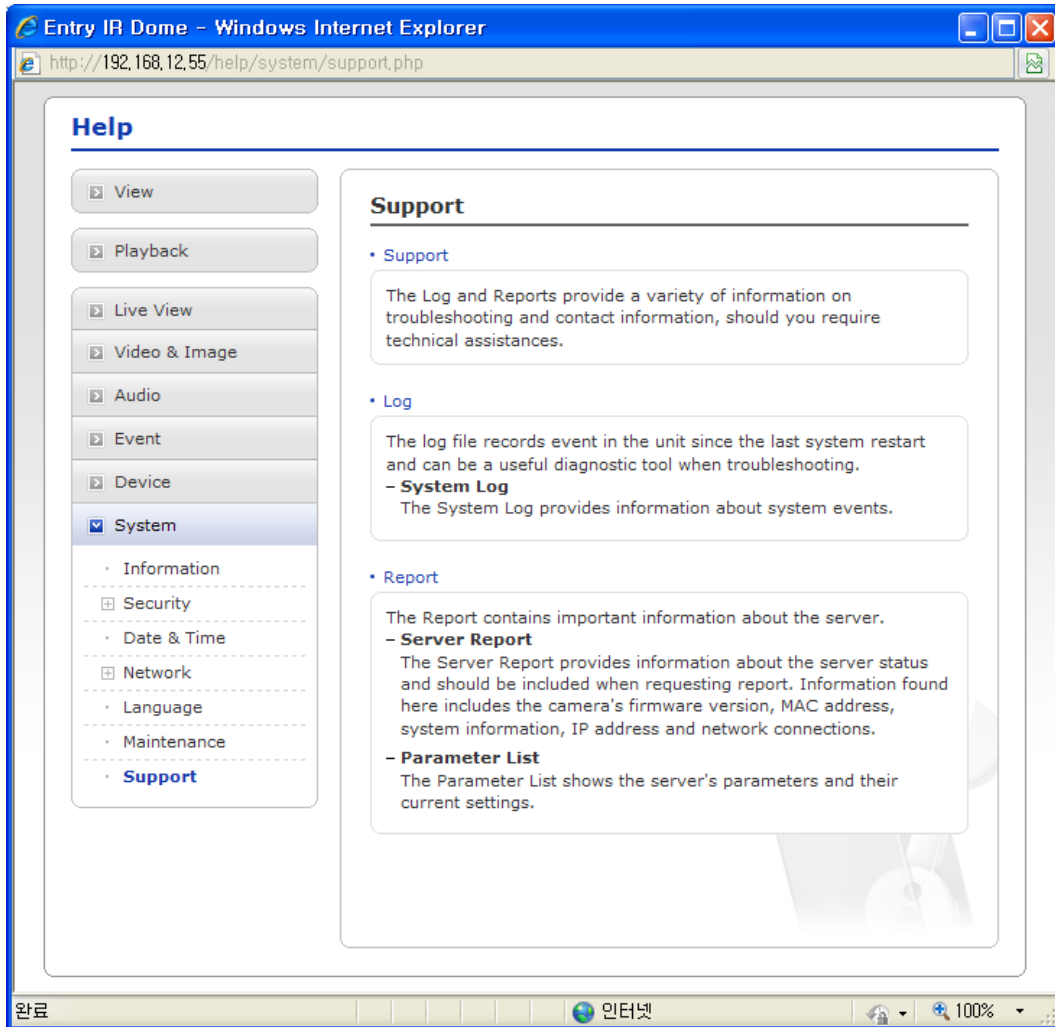

3.8 Resetting to the factory default settings

To reset the Network Camera to the original factory settings, go to the Setup>System> Maintenance web page (described in “3.5.5 System > Maintenance”) or use the Reset button on the network camera, as described below

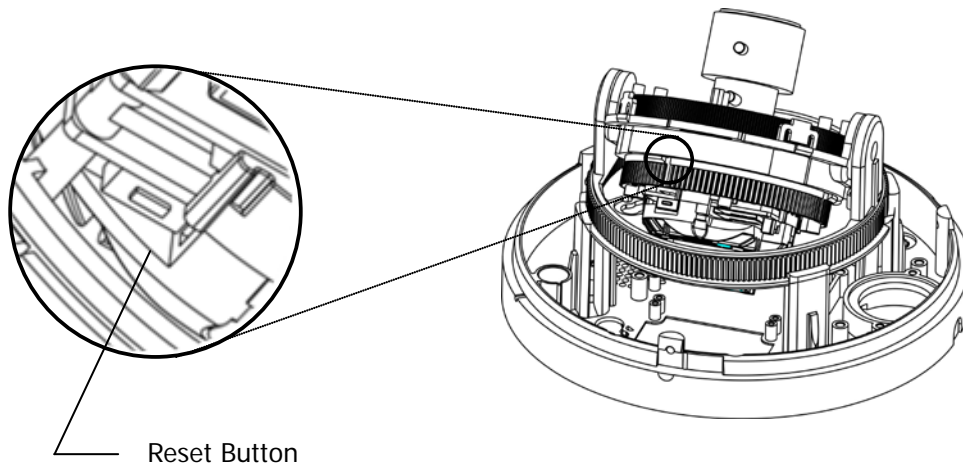

- **Using the Reset Button**

Follow the instructions below to reset the Network Camera to the factory default settings using the Reset button.

1. Switch off the Network Camera by disconnecting the power adapter.
2. Press and hold the Reset button while reconnecting the power.
3. Keep the Reset button pressed during about 2 seconds or more than.
4. Release the Reset button.
5. The network camera resets to factory defaults and restarts after completing the factory reset.

Caution: When performing a Factory Reset, you will lose any settings you have saved.
(Default IP 192.168.1.10)

4. Appendix

4.1 Troubleshooting

Troubleshooting if problems occur, verify the installation of the Network Camera with the instructions in this manual and with other operating equipment. Isolate the problem to the specific piece of equipment in the system and refer to the equipment manual for further information.

Problems/Symptoms	Possible Causes or Corrective Actions
The camera cannot be accessed by some clients.	If using a proxy server, try disabling the proxy setting in your browser. Check all cabling and connectors.
The camera works locally, but not externally.	Check if there are firewall settings that need to be adjusted. Check if there are router settings that need to be configured.
Poor or intermittent network connection.	If using a network switch, check that the port on that device uses the same setting for the network connection type (speed/duplex).
The camera cannot be accessed via a host name.	Check that the host name and DNS server settings are correct.
Not possible to log in.	When HTTPS is enabled, ensure that the correct protocol (HTTP or HTTPS) is used. When attempting to log in, you may need to manually type in http or https in the browser's address bar.
No image using Refresh and/or slow updating of images.	If images are very complex, try limiting the number of clients accessing the camera.
Images only shown in black & white.	Check the Video & Image setting.
Blurred images.	Refocus the camera.
Poor image quality.	Increased lighting can often improve image quality. Check that there is sufficient lighting at the monitored location. Check all image and lighting settings.
Rolling dark bands or flickering in image.	Try adjusting the Exposure Control setting under AE and AWB part.
H.264 not displayed in the client.	Check that the correct network interface is selected in the Video & Image/Stream.
Multicast H.264 not displayed in the client.	Check with your network administrator that the multicast addresses used by the camera are valid for your network. Check that the Enable multicast checkbox are enabled in the System/Network/RTP tab. Checks with your network administrator to see if there is a firewall preventing viewing.
Multicast H.264 only accessible by local clients.	Check if your router supports multicasting, or if the router settings between the client and the server need to be configured. The TTL value may need to be increased.
Color saturation is different in H.264 and Motion JPEG.	Modify the settings for your graphics adapter. Please see the adapter's documentation for more information.
Video cannot be recorded.	Check that the SD Card is inserted properly. Check that the SD Card is formatted properly.

4.2 Preventive Maintenance

Preventive maintenance allows detection and correction of minor that faults before they become serious and cause equipment failure.

Every three-month, perform the following maintenance.

1. Inspect all connection cables for deterioration or other damage.
2. Clean components with a clean damp cloth.
3. Verify that all the mounting hardware is secure.

4.3 Product Specification

Main Item		Specification
C A M E R A	Image sensor	1/2.8" Progressive scan RGB CMOS
	Active Array	1920(H) x 1080(V)
	Lens	Varifocal 3.5mm ~ 16.0mm, F1.2, DC IRIS
	Angle of View	3.5mm: 85°(H) x 47°(V)/16mm :26°(H) x 14°(V)
	IR Distance	20m (with built-in 30 IR LEDs)
	Min. illumination	Color: 0.2Lux, B/W: 0.0Lux (F1.2, 50IRE with IR On)
	Shutter Speed	1/20,000 ~ 1/30 (Slow shutter 1/15, 1/8 and 1/4)
N E T W O R K	Video Compression	- Motion JPEG - MPEG-4 Part2 - H.264 (MPEG-4 Part 10) - Profiles: H.264 HP, MP, and BP, MPEG-4 SP
	Video Streaming	Simultaneously H.264(or MPEG-4) and MJPEG Controllable Frame Rate and Bandwidth VBR/CBR H.264 and MPEG-4
	Video Resolutions	1920x1080 ~ 320x240
	Frame Rate	30fps @ All Resolution
	Protocol	TCP/IP, UDP, IPv4/v6, HTTP, HTTPS, QoS, FTP, uPnP, RTP, RTSP, RTCP, DHCP, ARP, Zeroconf, Bonjour
	Security	Multi-user authority, HTTPS, IP Filtering, Privacy Zone
	Max. Connection	10
	API Programming Interface	API Supported, Open Platform Compatible: ONVIF
	Alarm Events	- File upload via FTP and HTTP - Notification via E-mail, HTTP and TCP
	Video Buffering	Pre and Post Alarm
	Motion Detection	Yes, max. 8 programmable zone
	Network Time Synchronization	Yes
	SD Recording	Yes, Continuous/Event
	Software Reset	Yes
	Factory Reset	Yes, Button/Web browser
	Auto Recovery	Yes
Installation Tool	SmartManager, NC Titanium	
Upgrade	Web browser, SmartManager, NC Titanium	
G E N E R A L	Ethernet	RJ-45 10BASE-T/100BASE-TX
	Operating Temperature	0°C ~ 45°C
	Operation Humidity	0~80% (non-condensing)
	Power Consumption	DC 12V 600mA, 7.0W / PoE 130mA, 6.5W (with IR on) Power over Ethernet IEEE 802.3af Class0
	Dimensions (ø x H)	145.6ø x 113mm[Bubble Diameter: Φ100]
	Unit Weight	460g

System Requirement for Web Browser

Operating System: Microsoft Windows 98, Microsoft Windows ME, Microsoft Windows 2000, Microsoft Windows XP, or Microsoft Windows Vista, Windows 7, Windows 8

CPU: Intel Core 2 Duo 2Ghz or higher, 1GB RAM or more, 10GB free disk or higher

VGA: AGP, Video RAM 32MB or higher (1024x768, 24bpp or higher)

General performance considerations

When setting up your system, it is important to consider how various settings and situations will affect performance. Some factors affect the amount of bandwidth (the bit rate) required, others can affect the frame rate, and some affect both. If the load on the CPU reaches its maximum, this will also affect the frame rate.

The following factors are among the most important to consider:

- High image resolutions and/or lower compression levels (or high bitrates) result in larger images. Frame rate and Bandwidth affected.
- Accessing both Motion JPEG and H.264 video streams simultaneously. Frame rate and bandwidth affected.
- Heavy network utilization due to poor infrastructure. Frame rate and Bandwidth affected.
- Heavy network utilization via wireless router due to poor infrastructure. Frame rate and bandwidth affected.
- Viewing on poorly performing client PCs lowers perceived performance. Frame rate affected.



eneo® is a registered trademark of
VIDEOR E. Hartig GmbH
Exclusive distribution through specialised trade
chan-nels only.

VIDEOR E. Hartig GmbH
Carl-Zeiss-Straße 8 · 63322 Rödermark/Germany
Tel. +49 (0) 6074 / 888-0 · Fax +49 (0) 6074 /
888-100
www.videor.com
www.eneo-security.com

Technical changes reserved

© Copyright by VIDEOR E. Hartig GmbH 10/2015