

# HIGH PERFORMANCE MINIATURE DOME CAMERA

## OPERATION MANUAL



Thank you for choosing our high quality camera. Before attempting to connect or operate, please read and follow these instructions.

### CAUTIONS

These servicing instructions are for use by qualified service personnel only. To reduce the risk of electric shock do not perform any servicing other than that contained in the operating instructions unless you are qualified to do so.

In USA and Canada, Use Class 2 Power Supply Only.

**This device complies with Part 15 of the FCC Rules. Operation is subject to the following two conditions:**

1. This device may not cause harmful interference.
2. This device must accept any interference received, including interference that may cause undesired operation.

#### Note -

This equipment has been tested and found to comply with the limits for a Class A digital device, pursuant to part 15 of the FCC Rules. These limits are designed to provide reasonable protection against harmful interference when the equipment is operated in a commercial environment. This equipment generates, uses, and can radiate radio frequency energy and, if not installed and used in accordance with the instruction manual, may cause harmful interference to radio communications. Operation of this equipment in a residential area is likely to cause harmful interference in which case the user will be required to correct the interference at his own expense."

#### WARNING -

This is a class A product. In a domestic environment this product may cause radio interference in which case the user may be required to take adequate measures.

#### Caution -

Any changes or modifications in construction of this device which are not expressly approved by the party responsible for compliance could void the user's authority to operate the equipment.

#### ⚠ CAUTION ⚠

1. A regulated DC12V/DC5V 300mA power supply is recommended for use with this camera for the best picture and the most stable operation. An unregulated power supply can cause damage to the camera. When unregulated power supply is applied, product warranty will be out of subject.
2. It is recommended that the camera is used with a monitor that has a CCTV quality 75 video impedance level. If your monitor is switched to high impedance then please adjust accordingly.
3. Do not attempt to disassemble the camera to gain access to the internal components. Refer servicing to your dealer.
4. Never face the camera towards the sun or any bright or reflective light, which may cause smear on the picture and possible damage to the CCD.
5. Do not remove the serial sticker for the warranty service.



**WEEE**  
(Waste Electrical & Electronic Equipment)

This marking shown on the product or its literature, indicates that it should not be disposed with other household wastes at the end of its working life. To prevent possible harm to the environment or human health from uncontrolled waste disposal, please separate this from other types of wastes and recycle it responsibly to promote the sustainable reuse of material resources. Household users should contact either the retailer where they purchased this product, or their local government office, for details of where and how they can take item for environmentally safe recycling. Business users should contact their supplier and check the terms and conditions of the purchase contract. This product should not be mixed with other commercial wastes for disposal.



#### CAUTION

**RISK OF ELECTRIC SHOCK DO NOT OPEN**  
CAUTION: TO REDUCE THE RISK OF ELECTRIC SHOCK, DO NOT REMOVE COVER (OR BACK). NO USER SERVICEABLE PARTS INSIDE. REFER SERVICING TO QUALIFIED SERVICE PERSONNEL



This symbol is intended to alert the user to the presence of un-insulated "dangerous voltage" within the product's enclosure that may be of sufficient magnitude to constitute a risk of electric shock.







This symbol is intended to alert the user to the presence of important operating and maintenance (servicing) instructions in the literature accompanying the appliance.

### IMPORTANT SAFETY INSTRUCTIONS

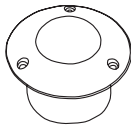
- 1) Read these instructions.
- 2) Keep these instructions.
- 3) Heed all warnings.
- 4) Follow all instructions.
- 5) Do not use this apparatus near water.
- 6) Clean only with dry cloth.
- 7) Do not block any ventilation openings. Install in accordance with the manufacturer's instructions.
- 8) Do not install near any heat sources such as radiators, heat registers, stoves, or other apparatus (including amplifiers) that produce heat.
- 9) Do not defeat the safety purpose of the polarized or grounding-type plug. A polarized plug has two blades with one wider than the other. A grounding type plug has two blades and a third grounding prong. The wide blade or the third prong are provided for your safety. If the provided plug does not fit into your outlet, consult an electrician for replacement of the obsolete outlet.
- 10) Protect the power cord from being walked on or pinched particularly at plugs, convenience receptacles, and the point where they exit from the apparatus.
- 11) Only use attachments/accessories specified by the manufacturer.
- 12) Use only with the cart, stand, tripod, bracket, or table specified by the manufacturer, or sold with the apparatus. When a cart is used, use caution when moving the cart/apparatus combination to avoid injury from tip-over. 
- 13) Unplug this apparatus during lightning storms or when unused for long periods of time.
- 14) Refer all servicing to qualified service personnel. Servicing is required when the apparatus has been damaged in any way, such as power-supply cord or plug is damaged, liquid has been spilled or objects have fallen into the apparatus, the apparatus has been exposed to rain or moisture, does not operate normally, or has been dropped.

### EQUIPMENT AND ACCESSORIES

Camera	
Video Output Cable	
Screw 4ea	
Operation Manual	

### SPECIFICATION

Signal Format	PAL
Image Device	1/3" 960H SONY Super HAD CCD II
Scanning System	2 : 1 Interlace
H.Resolution	700TV Lines
Scanning Frequency	15.625KHz(H), 50Hz(V)
Total Pixels	1020(H) X 596(V)
Effective Pixels	976(H) X 582(V)
Electronic Shutter Speed	1/50 ~ 1/100,000sec
S/N Ratio	More than 50dB(AGC OFF)
Gamma	γ = 0.45
Min. Illumination	0.1 Lux / F2.0
Sync System	Internal
Video Output	1.0 Vp-p Composite(75Ω)
White Balance	PUSH
Lens	Fixed Pinhole
2DNR	AUTO
Power Consumption	DC12V(±10%), Max. 90mA 210mA
Operating Temperature	-10°C~+50°C
Storage Temperature	-20°C~+60°C
Humidity	Less than 80%
Dimension(mm)	Wall mount type : 470 x 45(H) Ceiling Mount type : 650 x 45(H)

Specifications and designs are subject to change for improving the functionality of this product without notice.

## CONNECTION

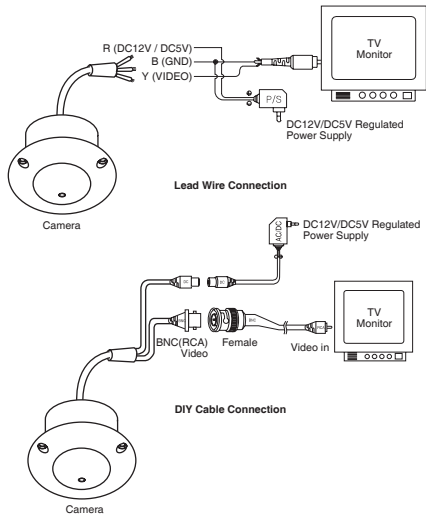

**!** When you install the camera, please glue up the end of cable to keep it stable in order to protect the camera from the humidity problems.

## ANGLE OF VIEW

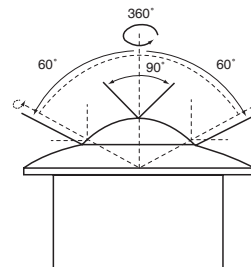

1. Camera revolves 360°
2. Camera ball is adjusted to max 60° from the axis to each end of the front case.
3. Viewable angle of the camera lens is 90° (Standard)  
\* 78° is available as an option.

## INSTALLATION

### 1. WALL MOUNT

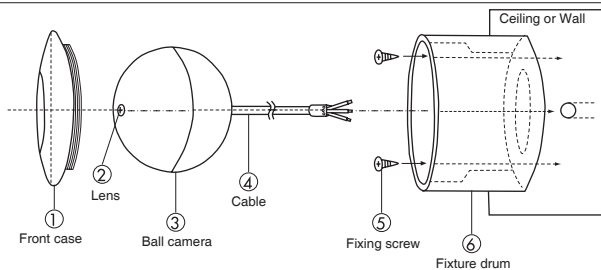

### 2. CEILING MOUNT

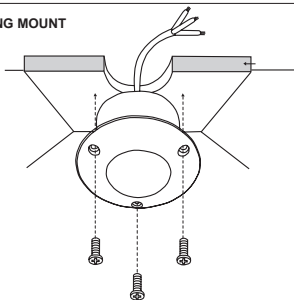

## DIMENSIONS

Unit(mm)

### 1. WALL MOUNT

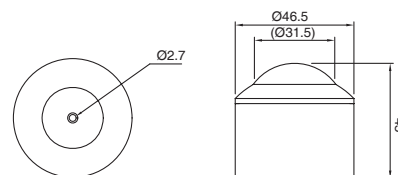

### 2. CEILING MOUNT

