



EN

Full Manual

Network Video Recorder

PNR-5316

PNR-5308



PNR-5304

Before reading this manual

This operation manual contains basic instructions on installing and using Network Video Recorder. Users who are using this product for the first time, as well as users with experience using comparable products, must read this operation manual carefully before use and heed to the warnings and precautions contained herein while using the product. Safety warnings and precautions contained in this operation manual are intended to promote proper use of the product and thereby prevent accidents and property damage and must be followed at all times. Once you have read this operation manual, keep it at an easily accessible location for future reference.

- ✓ The manufacturer will not be held responsible for any product damage resulting from the use of unauthorized parts and accessories or from the user's failure to comply with the instructions contained in this operation manual.
- It is recommended that first-time users of Network Video Recorder and individuals who are not familiar with its use seek technical assistance from their retailer regarding product installation and use.
- If you need to disassemble the product for functionality expansion or repair purposes, you must contact your retailer and seek professional assistance.
- Both retailers and users should be aware that this product has been certified as being electromagnetically compatible for commercial use. If you have sold or purchased this product unintentionally, please replace with a consumer version.

Safety Precautions

	CAUTION RISK OF ELECTRIC SHOCK DO NOT OPEN	
CAUTION: TO REDUCE THE RISK OF ELECTRIC SHOCK, DO NOT REMOVE COVER (OR BACK). NO USER-SERVICEABLE PARTS INSIDE. REFER SERVICING TO QUALIFIED SERVICE PERSONNEL.		



The lightning flash with arrowhead symbol, within an equilateral triangle, is intended to alert the user to the presence of uninsulated "dangerous voltage" within the product's enclosure that may be of sufficient magnitude to constitute a risk of electric shock.



The exclamation point within an equilateral triangle is intended to alert the user to the presence of important operating and maintenance (servicing) instructions in the literature accompanying the appliance.

Important Safeguards

1. Read Instructions

All the safety and operating instructions should be read before the appliance is operated.

2. Retain Instructions

The safety and operating instructions should be retained for future reference.

3. Cleaning

Unplug this equipment from the wall outlet before cleaning it. Do not use liquid aerosol cleaners. Use a damp soft cloth for cleaning.

4. Attachments

Never add any attachments and/or equipment without the approval of the manufacturer as such additions may result in the risk of fire, electric shock or other personal injury.

5. Water and/or Moisture

Do not use this equipment near water or in contact with water.

6. Ventilation

Place this equipment only in an upright position. This equipment has an open-frame Switching Mode Power Supply (SMPS), which can cause a fire or electric shock if anything is inserted through the ventilation holes on the side of the equipment.

7. Accessories

Do not place this equipment on an unstable cart, stand or table. The equipment may fall, causing serious injury to a child or adult, and serious damage to the equipment. Wall or shelf mounting should follow the manufacturer's instructions, and should use a mounting kit approved by the manufacturer.



This equipment and cart combination should be moved with care. Quick stops, excessive force, and uneven surfaces may cause the equipment and cart combination to overturn.

8. Power Sources

This equipment should be operated only from the type of power source indicated on the marking label. If you are not sure of the type of power, please consult your equipment dealer or local power company.

You may want to install a UPS (Uninterruptible Power Supply) system for safe operation in order to prevent damage caused by an unexpected power stoppage. Any questions concerning UPS, consult your UPS retailer.

9. Power Cords

Operator or installer must remove power and TNT connections before handling the equipment.

10. Lightning

For added protection for this equipment during a lightning storm, or when it is left unattended and unused for long periods of time, unplug it from the wall outlet and disconnect the antenna or cable system. This will prevent damage to the equipment due to lightning and power-line surges.

11. Overloading

Do not overload wall outlets and extension cords as this can result in the risk of fire or electric shock.

12. Objects and Liquids

Never push objects of any kind through openings of this equipment as they may touch dangerous voltage points or short out parts that could result in a fire or electric shock. Never spill liquid of any kind on the equipment.

13. Servicing

Do not attempt to service this equipment yourself. Refer all servicing to qualified service personnel.

14. Damage requiring Service

Unplug this equipment from the wall outlet and refer servicing to qualified service personnel under the following conditions:

- A. When the power-supply cord or the plug has been damaged.
- B. If liquid is spilled, or objects have fallen into the equipment.
- C. If the equipment has been exposed to rain or water.
- D. If the equipment does not operate normally by following the operating instructions, adjust only those controls that are covered by the operating instructions as an improper adjustment of other controls may result in damage and will often require extensive work by a qualified technician to restore the equipment to its normal operation.
- E. If the equipment has been dropped, or the cabinet damaged.
- F. When the equipment exhibits a distinct change in performance — this indicates a need for service.

15. Replacement Parts

When replacement parts are required, be sure the service technician has used replacement parts specified by the manufacturer or that have the same characteristics as the original part. Unauthorized substitutions may result in fire, electric shock or other hazards.

16. Safety Check

Upon completion of any service or repairs to this equipment, ask the service technician to perform safety checks to determine that the equipment is in proper operating condition.

17. Field Installation

This installation should be made by a qualified service person and should conform to all local codes.

18. Correct Batteries

Warning: Risk of explosion if battery is replaced by an incorrect type. Dispose of used batteries according to the instructions.

19. Tmra

A manufacturer's maximum recommended ambient temperature (Tmra) for the equipment must be specified so that the customer and installer may determine a suitable maximum operating environment for the equipment.

20. Elevated Operating Ambient Temperature

If installed in a closed or multi-unit rack assembly, the operating ambient temperature of the rack environment may be greater than room ambient. Therefore, consideration should be given to installing the equipment in an environment compatible with the manufacturer's maximum rated ambient temperature (Tmra).

21. Reduced Air Flow

Installation of the equipment in the rack should be such that the amount of airflow required for safe operation of the equipment is not compromised.

22. Mechanical Loading

Mounting of the equipment in the rack should be such that a hazardous condition is not caused by uneven mechanical loading.



23. Circuit Overloading

Consideration should be given to connection of the equipment to supply circuit and the effect that overloading of circuits might have on over current protection and supply wiring. Appropriate consideration of equipment nameplate ratings should be used when addressing this concern.

24. Reliable Earthing (Grounding)

Reliable grounding of rack mounted equipment should be maintained. Particular attention should be given to supply connections other than direct connections to the branch circuit (e.g., use of power strips).

In-Text

Symbol	Type	Description
	Caution	Important information concerning a specific function.
	Note	Useful information concerning a specific function.

User's Caution Statement

Caution: Any changes or modifications to the equipment not expressly approved by the party responsible for compliance could void your authority to operate the equipment.

FCC Compliance Statement

THIS EQUIPMENT HAS BEEN TESTED AND FOUND TO COMPLY WITH THE LIMITS FOR A CLASS A DIGITAL DEVICE, PURSUANT TO PART 15 OF THE FCC RULES. THESE LIMITS ARE DESIGNED TO PROVIDE REASONABLE PROTECTION AGAINST HARMFUL INTERFERENCE WHEN THE EQUIPMENT IS OPERATED IN A COMMERCIAL ENVIRONMENT. THIS EQUIPMENT GENERATES, USES, AND CAN RADIATE RADIO FREQUENCY ENERGY AND IF NOT INSTALLED AND USED IN ACCORDANCE WITH THE INSTRUCTION MANUAL, MAY CAUSE HARMFUL INTERFERENCE TO RADIO COMMUNICATIONS. OPERATION OF THIS EQUIPMENT IN A RESIDENTIAL AREA IS LIKELY TO CAUSE HARMFUL INTERFERENCE, IN WHICH CASE USERS WILL BE REQUIRED TO CORRECT THE INTERFERENCE AT THEIR OWN EXPENSE.

WARNING: CHANGES OR MODIFICATIONS NOT EXPRESSLY APPROVED BY THE PARTY RESPONSIBLE FOR COMPLIANCE COULD VOID THE USER'S AUTHORITY TO OPERATE THE EQUIPMENT.

THIS CLASS OF DIGITAL APPARATUS MEETS ALL REQUIREMENTS OF THE CANADIAN INTERFERENCE CAUSING EQUIPMENT REGULATIONS.

WEEE (Waste Electrical & Electronic Equipment)

Correct Disposal of This Product

(Applicable in the European Union and other European countries with separate collection systems)



This marking shown on the product or its literature, indicates that it should not be disposed with other household wastes at the end of its working life. To prevent possible harm to the environment or human health from uncontrolled waste disposal, please separate this from other types of wastes and recycle it responsibly to promote the sustainable reuse of material resources.

Household users should contact either the retailer where they purchased this product, or their local government office, for details of where and how they can take this item for environmentally safe recycling.

Business users should contact their supplier and check the terms and conditions of the purchase contract. This product should not be mixed with other commercial wastes for disposal.

The information in this manual is believed to be accurate as of the date of publication even though explanation about some functions may not be incorporated. We are not responsible for any problems resulting from the use thereof. The information contained herein is subject to change without notice. Revisions or new editions to this publication may be issued to incorporate such changes.

The software included in this product contains some Open Sources. You may obtain the complete corresponding source code from us. See the Open Source Guide on the software CD (OpenSourceGuide\OpenSourceGuide.pdf) or as a printed document included along with the User's Manual.

Table of Contents

1

Part 1 – Introduction.....	9
Product Features	9
Accessories.....	10
Overview	11
Front Panel.....	11
Rear Panel	14
Rear Panel Connections	14
Remote Control	18

2

Part 2 - Getting Started	21
Setup Wizard	21
Camera Registration.....	24
Device Scan.....	24
Advanced Setup: Video In IP Setup.....	25
Camera Registration Mode.....	26
Login	26
Live Mode.....	27
Live Menu	27
Zoom	30
PTZ Control.....	31
Event Monitoring	32
Covert Camera	32
Context Menu Access	33
Edit Group	33
Video Recording.....	33
Panic Recording.....	33
Audio Recording	34
Video Recording Playback	34
All Channel Playback	34
Remote Control Buttons during Playback	34
Context Menu.....	34

Part 3 - Configuration	35
Menu Use	35
Text Input via Virtual Keyboard	35
Batch Assignment	35
Mouse	36
System Setup	36
General	36
Date/Time	37
User	38
Storage	40
Monitoring	40
Record Setup	42
General	42
Schedule	43
Pre-Event	44
Event Setup (PLS-53xx)	45
Video-Analytics	45
Alarm-In	48
Video Loss	49
Audio Detection (PLS-53xx)	49
Text insertion (POS systems)	50
Network Setup	51
General	51
WAN	51
FEN	52
Device Setup	53
Alarm-Out	53
Display Setup	54
OSD	54
Main Monitor	54
Notification Setup	55
Schedule	55
Callback	55
Mail	55
SNS	56
Camera Setup	57
General	57

4

Advanced Setup (PLS-53xx).....	57
Stream.....	62
Audio (PLS-53xx).....	63
Upgrade (PLS-53xx).....	63

Part 4 - Search.....64

Time-Lapse Search.....	64
Search Menu.....	65
Time-Lapse Search Menu.....	66
Context Menu.....	69
Print.....	69
Event Log Search.....	70
Overlapped Recording Search.....	71

5

Part 5 - WebGuard.....72

Web Monitoring Mode.....	73
Web Search Mode.....	75

6

Part 6 - Appendix.....77

System Log Types.....	77
Error Code Types.....	78
Notes on first-time operation of ONVIF IP cameras (PX, PT, NX series).....	80
Recommended Network Setups.....	81
Cameras on the PNR, no WAN.....	81
Cameras on the PNR with WAN.....	82
Cameras in the local network.....	82
Cameras on the local network and on the PNR.....	83
Troubleshooting.....	84
Specifications.....	85
Index.....	87

Part 1 – Introduction

Product Features

This is a video recorder that supports surveillance, recording, and playback of video from pos (or video encoders).



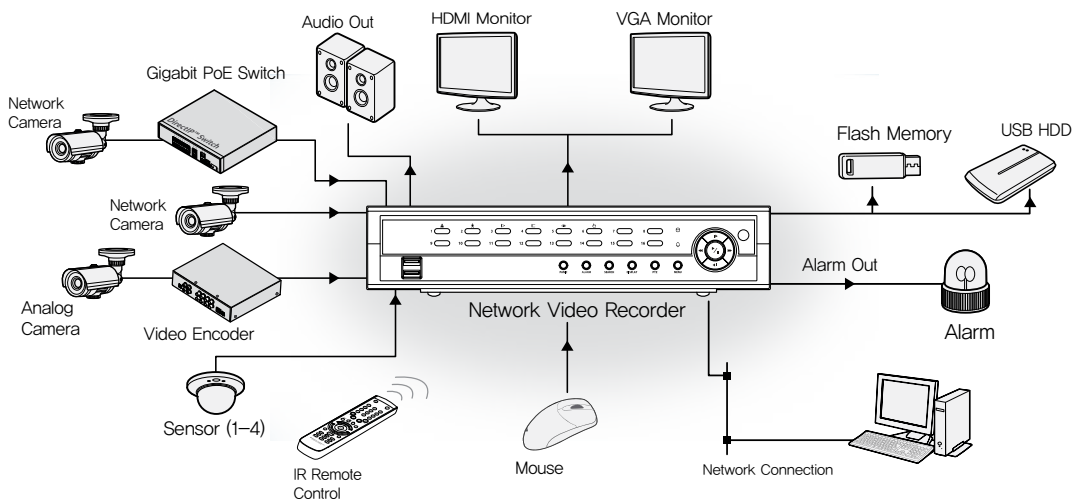

This NVR (Network Video Recorder) unit offers the following features:

- Real-time 4/8/16-channel network surveillance
- Supports Network Cameras with Zeroconf
- Supports up to Full HD 480ips video recording (4-ch model: 120ips video recording)
- HDMI out (1) and VGA out (1) ports
- Fast and easy search feature (Time-Lapse, Event log, Motion, Text-In)
- Simultaneously survey, record, play back, and transmit data in real-time
- Graphic User Interface(GUI) and multilingual
- Multiple recording modes (Schedule, Event, Pre-Event, and Panic)
- PoE-enabled Camera Connection
- 1 x USB 2.0, 1 x USB 3.0 ports (for connecting peripherals, upgrading software, and saving recording data)
- 2 internal SATA2 HDD bays and 1 eSATA port
- Two-way audio communication (not currently supported)
- Network camera audio recording and 1-channel audio playback
- 4 alarm ins and 1 alarm out
- IR remote control-enabled
- Self-diagnosis and automated system event alerts (industry standard S.M.A.R.T. protocol for HDD status alerts)

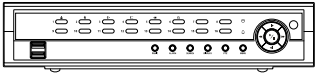
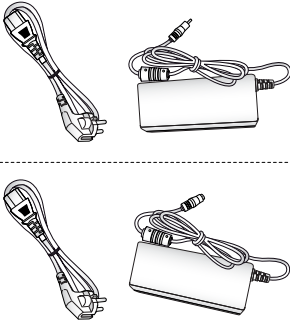
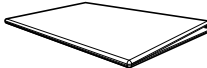

Accessories

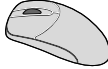
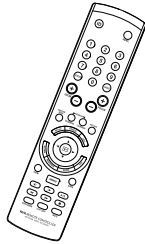
Upon unpackaging the product, check the contents inside to ensure that all the following accessories are included.

		
<p>Network Video Recorder</p>	<p>Power Cable / DC Adapter(12V, 48V)</p>	<p>Quick Guide</p>
		
<p>Operation Manual and Remote Program CD</p>	<p>Optical USB Mouse</p>	<p>IR Remote Control</p>
		
<p>Assembly Screws for Adding Hard Disk Drives</p>	<p>SATA2 cables</p>	

Overview

Front Panel

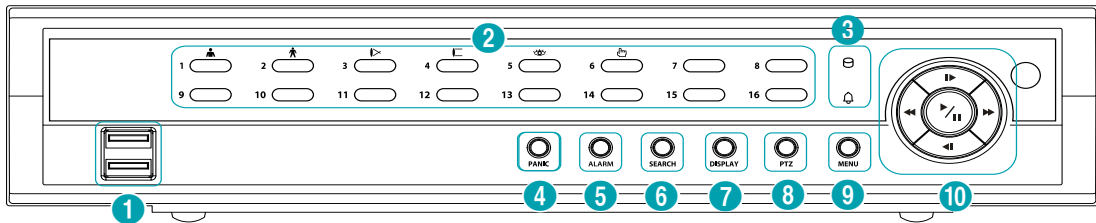

1	USB Ports	2	Camera Buttons	3	LEDs	4	Panic Recording Button
5	Alarm Button	6	Search Mode Button	7	Display Button	8	PTZ Button
9	Menu Button	10	Arrow and Playback Control Buttons				

- ✓ Some buttons have more than one function.
- Remote control sensor is located on the right side of the arrow buttons. Ensure that the sensor remains unobstructed at all times. If obstructed, the sensor might not be able to receive remote control signals.
- Placing a Wi-Fi, Bluetooth, or any other wireless communication device near the NVR may interfere with remote control signal transmission.
- Access various windows and menus using a USB mouse as you would on a personal computer.
- For easier system configuration, a USB mouse is recommended.

① **USB Ports**

• **Storage Device Connection**

Connect an external USB hard drive or a USB flash memory device to one of the USB ports for use with the Clip Copy feature. The external storage device should be placed as close to the NVR as possible. It is recommended that you use a connection cable that is no longer than 180cm in length. Use the connection cable included with your external storage device to connect the device to one of NVR's USB ports. For more information Clip Copy, refer to the **5 Clip-Copy on page 67**.

• **Peripheral Device Connection**

Use the USB ports to connect peripherals such as a USB mouse to the NVR. You can also use a USB-to-serial converter and connect multiple text-in devices to the NVR at the same time.



For USB flash memory devices, the NVR supports the FAT32 file format only.

② **Camera Button**

Pressing the **Camera** button while in Live or Playback mode displays images from the selected camera in full screen. To select a camera whose channel is made up of two digits, enter the digits in sequence using the number keys.

③ **LEDs**

- **HDD LED:** Flashes when data is being written on the HDD or a video search is in progress.
- **Alarm LED:** Lights up in red when an alarm event occurs.

④ **Panic Recording Button**

Pressing the **PANIC** button displays the **!** icon and commences recording irrespective of the current schedule. Press the button again to deactivate Panic Recording mode.

⑤ **Alarm Button**

Pressing the **ALARM** button while the alarm has been activated resets all NVR outputs, including the built-in buzzer. Pressing the button while the alarm is off displays the event log on the screen.

⑥ **Search Mode Button**

Pressing the **SEARCH** button initiates Search mode, which will allow you to search for and play back video recordings. Pressing the **SEARCH** button while in Search mode

returns the screen to Live mode.

⑦ **Display Button**

Press the **DISPLAY** button to toggle screen formats.

⑧ **PTZ Button**

Pressing the **PTZ** button initiates PTZ mode, allowing you to control PTZ cameras. In PTZ mode, use the arrow buttons to move the camera up, down, left, and right.

1	Zoom-In
2	Zoom-Out
3	Focus Near
4	Focus Far
5	Preset View
6	Preset SET

⑨ **Menu Button**

Pressing and holding the **MENU** button for 3 seconds while in Live mode displays the Live menu. Pressing the **MENU** button while in Search mode displays the Search menu. Press the button once more to close the menu. Pressing and holding the **MENU** button for 3 seconds while in Playback mode activates One-Touch mode and displays the clip copy window.

⑩ **Arrow and Playback Control Buttons**

These buttons are used to select menus and options.

Play/Pause (▶/) Buttons	Plays the video in normal speed and displays ▶ on the screen. Press again during playback to pause the video and display on the screen.
Setup Menu	Up/Down/Left/Right Buttons: Moves the focus up, down, left, or right. Up/Down Buttons: Increases or decreases values.

Playback Mode

From paused state:

◀| Button: To the previous screen

|▶ Button: To the next screen

◀◀ Button: Scans backward through the video at a fast rate. (Press to cycle through ◀◀, ◀◀◀, and ◀◀◀◀ the speed)

▶▶ Button: Scans forward through the video at a fast rate. (Press to cycle through ▶▶, ▶▶▶, and ▶▶▶▶ the speed)

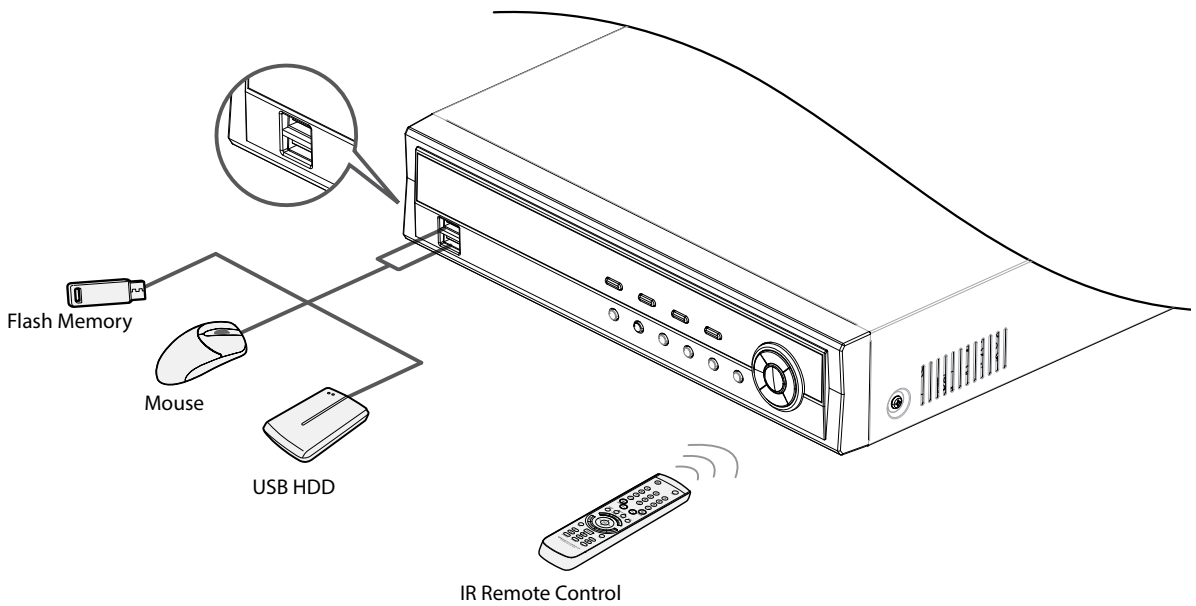
Connections on the Front Panel

Rear Panel

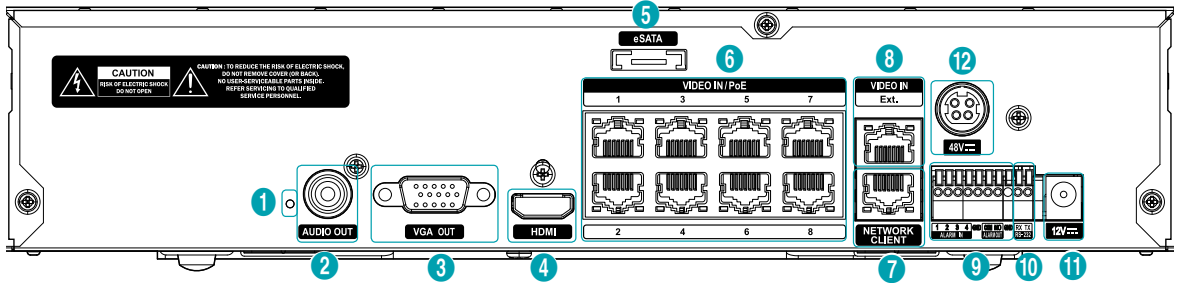

1	Factory Reset Button	2	Audio Ports	3	VGA Out Port
4	HDMI Out Port	5	eSATA Port	6	Video In / PoE Ports
7	Network Port	8	Video In / Ext. Port	9	Alarm Connection Ports
10	RS-232 Port	11	Power In Port (12V)	12	Power In Port (48V)

Rear Panel Connections

Monitor Connection

Connect to the **VGA OUT** or **HDMI** port.

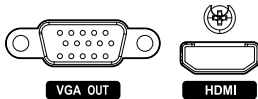

Audio Connection



Connect the speakers with a built-in amplifier to the **AUDIO OUT** port. Use the **AUDIO OUT** port to listen to audio from network cameras.

- This NVR does not feature a built-in audio amplifier unit and therefore requires the user to purchase a speaker system with a built-in amplifier separately.
- Check your local laws and regulations on making audio recordings.

Video Connection

- **Video In/PoE Port**

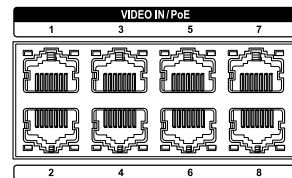

Connect network cameras or video encoders to the NVR using RJ-45 cable (Cat5, Cat5e, or Cat6).

- Green LED on the right will turn on when PoE comes on line. Orange LED on the left will then flash once a link has been established.
- If more than 16 cameras from video encoders are registered on the NVR, video may not be displayed smoothly in a remote program.

• **Video In/Ext. Port**

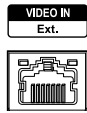

This port does not support PoE. It's possible to establish a network with network cameras and external hubs using a Cat6 cable.



- This port is only available in Recorders with 8/16 channels.
- Green LED on the right will turn on if connected to a 1000 BASE-T network. Orange LED on the left will then flash once a link has been established.
- When using a Cat5e cable, the data transfer speed may decrease depending on how to establish a network.

eSATA Connection

Connect external hard drives to these ports.



Do not connect or disconnect an eSATA device while the NVR is powered on. To connect an eSATA device, first turn off the NVR and unplug the power cable. Connect the eSATA device and then power the eSATA device first and then NVR back on. To disconnect an eSATA device, first turn off the NVR and unplug the power cable. Turn off the eSATA device and then disconnect the eSATA connection cable.

Network Connection



This NVR is capable of connecting to networks via an ethernet connector. Connect an RJ-45 cable (Cat5, Cat5e, or Cat6) to the NVR's network port. It's possible to operate and upgrade the NVR remotely over a network. For more information on ethernet connection setup, refer to **Network Setup on page 51**.



Green LED on the right will begin to flash if connected a 1000 BASE-T network. Orange LED on the left will then flash once a link has been established.

RS-232 Connection

Connect an external device such as a POS unit to this port.



Alarm Connection

Connect alarm connectors to these ports.

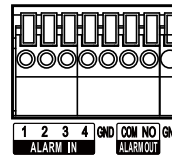

Press down on the button and insert the cable into the opening. Release the button and then pull on the cable slightly to ensure it is held securely in place. To disconnect the cable, press down on the button again and pull the cable out.

• **Alarm In 1 through 4**

This NVR is capable of responding to event signals from external alarm in devices. Connect mechanical or electrical switches to AI 1 through 4 and the GND (ground) connector. In order to be recognized by the NVR, the signal from an alarm in device must be less than 0.3V and maintained for at least 0.5 seconds. The alarm in voltage range is 0V to 5V. For more information on alarm in setup, refer to the **Alarm-In on page 48**.

• **GND (Ground)**

Connect alarm in or out's ground cable to the GND connector.



All connectors marked "GND" are common connectors.

• **NO (Relay Alarm Outputs)**

This NVR is capable of activating/deactivating buzzers, lights, and other external devices. Connect a mechanical or electrical switch to NO and COM connectors. Electrical specifications are 2A sync at 125VAC and 1A sync at 30VDC. For more information on alarm out setup, refer to the **Alarm-Out on page 53**.

• **Connector Arrangement**

ALARM IN 1 through 4	Alarm In 1 through 4
GND	Ground
ALARM OUT COM	Relay Common
ALARM OUT NO	Normally Open Relay Alarm Out (connected to COM port)

Power Cable Connection



This NVR does not feature a separate power on/off button and will turn on the moment power is supplied. Connect the connector(12V) of adapter to the NVR and then connect the AC power cable of adapter to the power outlet.



This NVR is built in PSE(Power Source Equipment) to connect the PoE-enabled network camera. Connect the connector(48V) of adapter to the NVR and then connect the AC power cable of adapter to the power outlet.

- Organize the power cable so that it will not cause people to trip over or become damaged from chairs, cabinets, desks, and other objects in the vicinity. Do not run the power cable underneath a rug or carpet.
- The power cable is grounded. Do not modify the power plug even if your power outlet does not have a ground contact.
- Do not connect multiple devices to a single power outlet.

Factory Reset



Located next to the Audio Out port on the rear of the NVR is a switch that, once activated, will reset the NVR to all its initial factory settings.

A factory reset will clear all NVR settings configured by the user.

You will need a straightened paper clip to access the factory reset button.

- 1 Turn off the NVR.
- 2 Insert a straightened paper clip into the factory reset switch hole and press the switch. Turn on the NVR while holding the switch.
- 3 Press and hold until you hear 2 beeps from the NVR's internal buzzer.
- 4 All NVR settings will be returned to their factory values once you remove the paper clip.

Connections on the Rear Panel

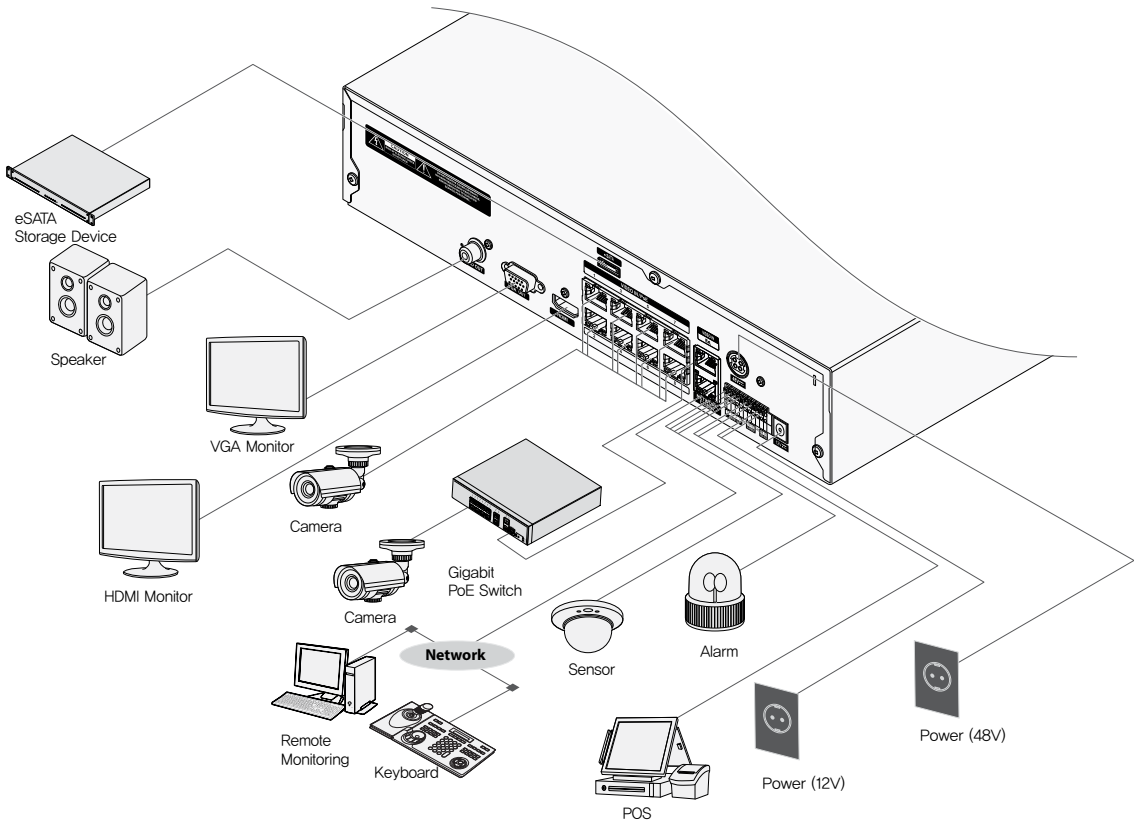

Remote Control

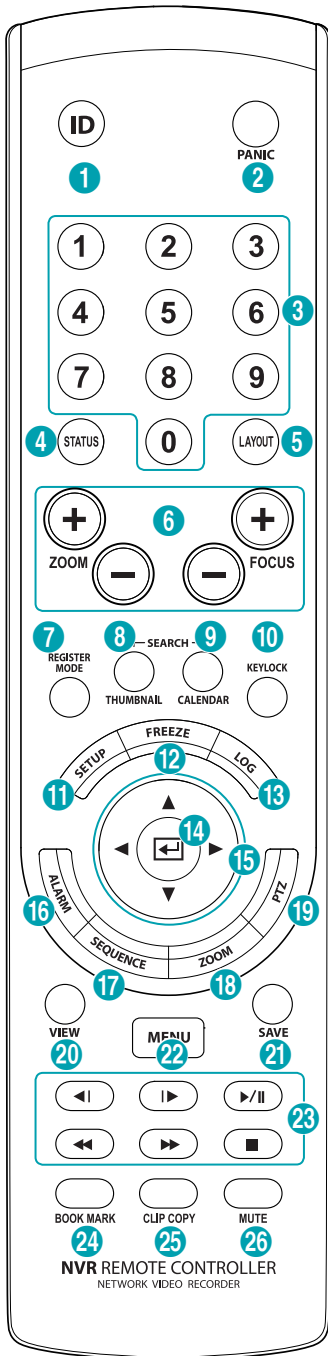

1	ID Button
2	PANIC Button
3	Camera Buttons
4	STATUS Button
5	LAYOUT Button
6	PTZ Control Buttons
7	REGISTER MODE Button
8	THUMBNAIL Button
9	CALENDAR Button
10	KEYLOCK Button
11	SETUP Button
12	FREEZE Button
13	LOG Button
14	Enter Button
15	Arrow Buttons
16	ALARM Button
17	SEQUENCE Button
18	ZOOM Button
19	PTZ Button
20	VIEW Button
21	SAVE Button
22	MENU Button
23	Playback Buttons
24	BOOKMARK Button
25	CLIP COPY Button
26	MUTE Button

① **ID** Button

Used to assign remote control ID values.

No additional remote control assignment is necessary if the system's ID is 0. If the system's ID is a number between 1 and 9, however, you will need to press the ID button and then press the system ID number (1 through 99) on the remote control. The  (remote control) icon will appear on the upper right corner of the NVR screen (status indication area) to indicate successful system-to-remote control pairing. If using multiple systems, it's possible to control all the units with a single remote control as long as all the system IDs are 0. For more information on system IDs, refer to the **System Setup on page 36**.

② **PANIC** Button

Pressing this button commences recording irrespective of the current schedule.

Press the button again to deactivate Panic Recording mode.

③ **Camera** Buttons

Pressing the **Camera** button while in Live or Playback mode displays images from the selected camera in full screen. To select a camera whose channel is made up of two digits, enter the digits in sequence using the number keys.

④ **STATUS** Button

Displays event recording device and network statuses.

⑤ **LAYOUT** Button

2x2 > 3x3 > 4x4

⑥ **PTZ** Control Buttons

Used in PTZ mode to zoom in/out on the screen and to shift focus between a nearby point and a far away point.

⑦ **REGISTER MODE** Button

Used in Live mode to access Camera Registration mode.

⑧ **THUMBNAIL** Button

Used in Playback mode to access Thumbnail Search mode. Thumbnail Search mode displays thumbnails of video recordings and allows you to search recordings based on date and time parameters. (Will be supported.)

⑨ **CALENDAR** Button

Displays a video recording playback screen that includes a calendar.

⑩ **KEYLOCK** Button

Locks out all remote control keys. To unlock, press the button again.

⑪ **SETUP** Button

Displays the Live menu in Live mode or **Control Area** menu in Search mode. Selecting **Top** by using this button in the **Control Area** menu displays the Search menu. For more information on the Control Area menu, refer to **Time-Lapse Search on page 64**. Press the button once more to close the menu.

Pressing this button while a camera screen is selected by pressing the **Enter** () button in Live mode displays the Camera menu. Selecting Camera Registration displays NVR and IP Camera Setup window.

Pressing and holding this button for 3 seconds activates One-Touch mode and displays the clip copy window. If the Search menu is displayed on the top of the screen, One-Touch mode is not activated.

⑫ **FREEZE** Button

Used to pause Live screen.

⑬ **LOG** Button

Displays system log window and allows you to search the log.

⑭ **Enter** Button

Used to make menu option selections and register data entries. In addition, pressing this button while a camera screen is selected by pressing the Menu button in Live or Playback mode displays the Camera menu.

15 **Arrow** Buttons

Used to navigate through menus and interact with GUIs. In a Setup menu, use the **Up/Down Arrow** buttons to increase or decrease numerical values. In Live or Playback mode, use the **Left/Right Arrow** buttons to view the previous or next screen.

16 **ALARM** Button

Pressing this button while the alarm has been activated resets all NVR outputs, including the built-in buzzer. Displays the event log on the screen when the alarm is off in Live mode.

17 **SEQUENCE** Button

Pressing the **SEQUENCE** button while in Live mode initiates Live Sequential mode (displays channels in sequence).

18 **ZOOM** Button

Used to zoom in on a specific part of the screen. Once zoomed in, use the arrow buttons to pan around.

19 **PTZ** Button

Initiates PTZ mode and allows you to control the selected PTZ camera.

20 **VIEW** Button

Pressing the **VIEW** button while in PTZ mode displays the preset list.

21 **SAVE** Button

Press the **SAVE** button while in PTZ mode to save the current position as a preset.

22 **MENU** Button

Pressing the **MENU** button while in Live mode displays the Live menu. Alternatively, pressing the button while in Search mode displays the Search menu. Press the button once more to close the menu. Use the arrow buttons to select menus and options.

23 **Playback** Buttons

◀◀	Scans backward through the video at a fast rate. (Press to cycle through ◀◀, ◀◀◀, and ◀◀◀◀ the speed)
▶/	Plays the video in normal speed and displays ▶ on the screen. Pressing the ▶/ button during playback pauses the video and displays on the screen.
▶▶	Scans forward through the video at a fast rate. (Press to cycle through ▶▶, ▶▶▶, and ▶▶▶▶ the speed)
■	Stops the video and restores Live mode.
◀	Skips to the previous screen (while in paused state).
▶	Skips to the next screen (while in paused state).

24 **BOOKMARK** Button

When in the playback mode, pressing the **BOOKMARK** button allows you to display the bookmark window.

25 **CLIP COPY** Button

Used to perform Clip Copy.

26 **MUTE** Button

Temporarily disables audio.

Part 2 - Getting Started

Setup Wizard

Setup Wizard lets you configure basic settings required for operating the system.

 Setup Wizard only appears during initial booting. To use Wizard after initial booting, go to Live menu and select Wizard.

1 Select a system language.



2 Select the desired Setup Wizard option and click **Next**. (This does not appear during initial booting)



 Select **Cancel** from any of the Wizard screen to cancel the setup process and return to the main setup menu.

Quick Wizard

1 Select Quick Wizard.



2 Specify the current date and time and then click **Next**.

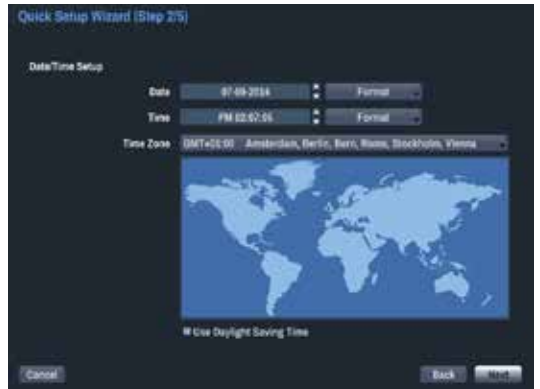

-  The new date and time settings will only be applied after clicking **Next**.
- For more information on date and time settings, refer to the **Date/Time** section under System Setup on page 36.

3 Choose the desired **Recording Method** and click **Next**.



4 Choose the desired **Recording Quality** and click **Next**.



-  • Higher recording quality uses up more disk space.
- Recording resolution is determined based on the selected recording quality.
 - **High Video Quality Priority Profile:** Very high
 - **Standard Recording Profile:** High
 - **Longer Recording Time Priority Profile:** Standard

– Recording resolutions used under each recording method and record video quality setting are as follows:

	High Video Quality Priority Profile	Standard Recording Profile	Longer Recording Time Priority Profile
Motion Event Record	Very high	High	Standard
Continuous & Motion Event Record	Very High (Continuous) / Very high (Motion)	High (Continuous) / High (Motion)	Standard (Continuous) / Standard (Motion)
Continuous	Very high	High	Standard

5 Click **Finish** to exit Quick Wizard.



Network Wizard

 After exiting from Quick Wizard, you can click **Go to Network Setup** and set up the network with Network Wizard.

1 Select Network Wizard.



- 2 Specify whether the system is connected to the Internet and click **Next**.



 If you have chosen **No**, wait for the test to finish and then click **Finish** to exit Network Wizard.

- 3 Select Network Configuration and then click **Next**. Select either Auto Configuration or Manual Configuration and then click **Test** to test the system's current network configuration.



-  • This test must be performed before proceeding to the next step.
- If the NVR is on a network connected to a network that has a DHCP server, selecting **Auto Configuration** retrieves LAN settings such as IP and DNS addresses automatically. Selecting **Manual Configuration**, on the other hand, lets you specify the settings manually.
 - **UPnP support device not found.** If this error message is displayed, check to see if the IP router (or NAT) supports UPnP and if UPnP has been enabled. For more information about the router's UPnP function, refer to the router's operation manual.

- 4 Enter in the **Device Name** field the NVR name to be registered on the FEN server and then click **Check** to check its availability.



-  The device name you register on the FEN server will be a unique name used to identify the NVR. Once registered, the name can be used to access the NVR directly from clients such as iRAS. Check the name's availability to complete the registration process. The Finish button will then become activated.
- You will be prompted with an error message if you do not enter a name for the NVR or enter a name already registered on the FEN server.
- Depending on the network environment, FEN services may not be active and therefore prevent the NVR from connecting to the network. In this case, you will need to manually configure the ports. For more information on port configuration, refer to [Network Setup on page 51](#).

- 5 Click **Finish** to exit Network Wizard.



Camera Registration

Once Network Setup Wizard is complete, click the "Scan" button to scan for cameras connected to NVR. Also you can delete and register cameras.



- **Title:** Indicates the camera's title. Left-click on the title to edit the camera's title.



Device Scan

Click the "Scan" button and the Device Scan screen appears.

- Some functions may not be supported for the third party cameras depending on their protocol and model.

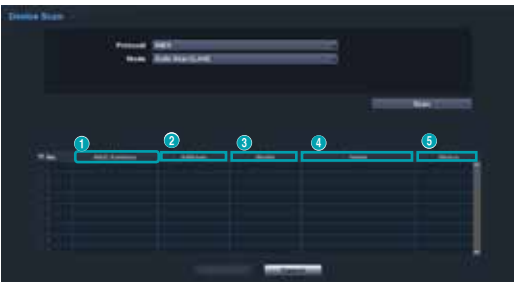

- **Protocol:** Select the protocol used by the camera (or video encoder) you wish to search for.
 - ONVIF: PX, PT and NX series
 - iNEX: PLS-53xx

- Even if the network device uses a protocol supported by the NVR, the device itself may not be visible for scanning and registration by the NVR. For more information about supported network devices and models, contact your retailer.

- **Mode:** Select the scan mode.
 - **Auto Scan (LAN):** Lists cameras in a LAN environment. If Auto Scan (LAN) fails to recognize a camera, try using IP Address Scan instead.
 - **IP Address Scan:** Enter the IP address of a camera. The NVR scans for the camera matching the specified address. If you enter IP address's range, the NVR scans for cameras falling under the specified address's range. By specifying an IP address, you can also specify which port to use with the Remote Admin feature. It is recommended that the camera not be networked via DHCP (Dynamic Host Configuration Protocol). If the camera is networked via DHCP, connection to the camera may not be made properly depending on changes in the external network environment.

- ① **Mac Address:** Displays the last 6 digits of the camera's MAC address.
- ② **Address:** Indicates the camera's searched IP address.
- ③ **Model:** Indicates the camera's model.
- ④ **Name:** Indicates the camera's name.
- ⑤ **Status:** Identifies the camera's registration status "registered" or "not registered."

Advanced Setup: Video In IP Setup

If the camera is networked but not scanned, use this setup. This setup allows you to change the network setting of the NVR's VIDEO IN port which is camera's network environment. Check the camera's network setting first before you use this setup.

- Make sure that this setting does not conflict with the WAN setting. For more information on the WAN setting, refer to **WAN on page 51** as well as the [Appendix under Recommended Network Setups](#).



- **Link-local address:** Disables this advanced setup. For cameras with ZeroConf function such as NX series.
- **Manual:** Allows you to enter the IP address and other network settings manually.
- **DHCP Client:** Retrieves an IP address and other network settings automatically from a DHCP server.
- **DHCP Server:** It makes the NVR run as a DHCP server. Select **Searching DHCP Server** to check if there is any DHCP server in the same network. If there is no DHCP server, this option is enabled. The NVR allocates an IP address automatically in the range of 10.10.0.128 to 10.10.254.254 by using DHCP to the camera connected to the NVR's VIDEO IN port.

- When several NVRs exist in the same network, only one of NVRs has to be run as a DHCP server.

- 1 Select **Scan** to commence scanning.

- Only cameras that are connected to the NVR via VIDEO IN ports can be scanned and registered.

- 2 Select a camera from the scan list and then select **Add Camera**. The device login window will appear.

- 3 Enter a **User ID** and a **Password** for the selected camera.



- **Apply to All Devices:** Selects to apply the same user and password to all selected devices if you selected more than one device and the selected devices have the same user ID and password.

Camera Registration Mode

While in Live mode, right-click and select **Camera Registration**.



Login

Configuring the NVR's settings and accessing its searching and other functions require an authorized user login.

1 While in Live mode, right-click on the mouse and select **Login** and either press the **SETUP** button on the remote control.



2 Select a user, enter the password, and then select **OK**.

- There is no default password for the admin account. Select **admin** and then **OK** without entering a password to log in.
- Leaving the admin account unassigned with a password poses a security risk. Please assign a password at your earliest convenience. A warning message will continue to be displayed until a password is assigned.
- Click on the button next to the password field using the mouse. This will bring up a virtual keyboard you can use to assign a password. For more information on using the virtual keyboard, refer to the [Text Input via Virtual Keyboard on page 38](#).

3 To log out, right-click on the mouse and select **Logout**.



Live Mode

Live Menu

Press the **MENU** button on the NVR's front panel while in Live mode to bring up the Live menu on the right edge of the screen. Press **MENU** button once more to hide the menu. Use the Arrow buttons on the remote control to select the menu options.

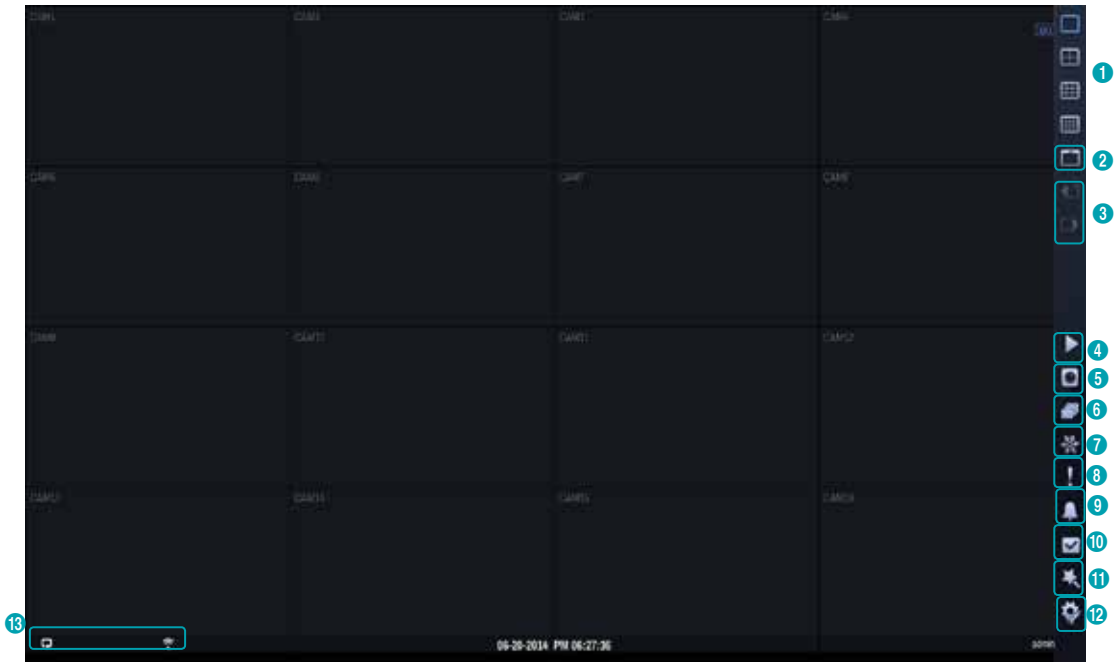

1	Layout	2	Display	3	Previous Group, Next Group	4	Search Mode
5	Select Camera	6	Sequeunce	7	Freeze	8	Panic Recording
9	Alarm	10	Status	11	Wizard	12	Setup
13	Status Indication						



Placing the mouse pointer near the right edge portion of the screen also displays the Live menu.

① **Layout**

Used to change the screen layout.

② **Display**

- **OSD** (On Screen Display): Enables/disables the **OSD** feature.
- **Aspect Ratio**: Select whether to enable the original aspect ratio of video transmitted from the camera.

③ **Previous/Next Group**

Loads the previous/next screen group.

④ **Search Mode**

- **Time-Lapse Search**: Select **Search Mode > Time-Lapse Search** to search for and play back saved data directly from the record table.
- **Event Log Search**: Select **Search Mode > Event Log Search** to search for event logs and play back associated event recordings.

⑤ **Select Camera**

Displays the selected camera in a single screen format.

⑥ **Sequence**

Initiates **Sequence** in the same manner as pressing the **SEQUENCE** button on the remote control while in Live mode. To exit, select **Sequence** once more or press the **SEQUENCE** button. The  icon is displayed on the bottom left part of the screen while Sequence is in progress.

Full Sequence

Displays all channels in sequence while in Live mode (single and split screen settings). In order to use the Full Sequence feature, **Full Sequence** (Display Setup - Main Monitor > Sequence) must first be enabled.

e.g.) Full Sequence



Cameo Sequence

In **Cameo Sequence** mode, only the bottom right screen in a split screen setup changes sequence. In order to use the **Cameo Sequence** feature, **Cameo Sequence** (Display Setup - Main Monitor > Sequence) must first be enabled.

e.g.) Cameo Sequence in 2x2 split screen mode

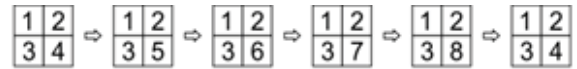

- If using the **Full Sequence** setting, page numbers appear on the system status area on the bottom left part of the screen, next to the Sequence icon.
- Pages are skipped under the following circumstances:
 - If all cameras included in the page are deactivated.
 - If there are no video signals.
 - If the page contains "covert" cameras.
 - If the user does not have permission to view feeds from the cameras.

⑦ **Freeze**

Freezes the screen. Select **Freeze** again to unfreeze.

⑧ **Panic Recording**

Activates/deactivates Panic Recording

⑨ **Alarm**

Pressing this button while the alarm has been activated resets All NVR outputs, including the built in buzzer.

10 Status

Event

This screen displays an overview of all events. When an event occurs, the corresponding channel flashes for 5 seconds.



Event Types

	Alarm-In		Check Alarm-In
	Motion		Video Loss
	Audio Detection		Trip Zone
	Tampering		Text-In

- **Panic Record:** Displays event status based on current Panic Record status.
- **Check Recording:** Displays event status based on **System Monitoring** settings. For more information, refer to the **Monitoring on page 40**.
- **Disk Almost Full/Disk Full:** If the storage device is not in **Recycle** status, event status is displayed when the amount of disk space specified under **System Monitoring** is reached and when the disk becomes 100% full. For more information, refer to the **Monitoring on page 40**.
- **Fan Error:** Event is indicated when the cooling fan cannot reach a certain RPM or fails for longer than 50 seconds.
- **Disk Config Change:** It will be highlighted when the NVR reboots after the hard disk drive has been replaced.

Storage

Indicates each disk's status.

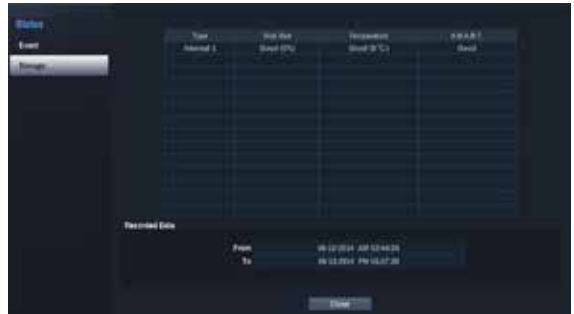

• Disk Bad

Not Formatted	A disk that has never been used before.
Good	<ul style="list-style-type: none"> • Disk performing normally. • If the HDD is partially damaged, indicates the bad sector percentage.
Error	<ul style="list-style-type: none"> • If the HDD's bad sector ratio is higher than as designated by the user. • Generates a system event.

• Temperature

N/A	Unable to detect the disk's temperature.
Good	Operating within normal temperature range.
Bad	<ul style="list-style-type: none"> • Disk temperature higher than as designated by the user. • Generates a system event.

• S.M.A.R.T.

N/A	A disk that does not support S.M.A.R.T.
Good	A disk with normal S.M.A.R.T. status.
Bad	A disk with abnormal S.M.A.R.T. status. Possibility of damage within 24 hours.

- Configure Disk Bad and Disk Temperature settings under **Setup > System > Monitoring**.
- Check each disk's data storage time information under **Recording Data**.

11 Wizard

Launches the Setup Wizard.

12 Setup

Used to access the Setup menu.

13 Status Indication

Displays system status icons.-



Status Indication

-  Indicates remote control receptivity.

-  Indicates connection to the NVR from a remote program.

-  Indicates a zoomed in state.

-  Indicates Freeze is in use.

-  Indicates Sequence is in use.
- 1/4** Indicates the current screen's group.
-  Indicates an event monitoring.

-  Indicates HDD use. The icon to the left is shown if using the overwrite setting. Otherwise, remaining HDD space is shown as a percentage value.

Zoom

Press the **ZOOM** button on the remote control and select a channel you wish to zoom in on. A zoom frame will appear on the selected channel. Use the arrow buttons to position the frame. Press the **Play/Pause** button to cycle through various zoom factors. When Zoom is activated,  icon is on the status bar located on the bottom left corner of the system.

- In Full Screen mode, activating Zoom automatically selects the current channel.
- To restore the channel to normal size, press the Zoom button again.

PTZ Control

While in Live mode, right-click and select PTZ from the context menu or press the **PTZ** button on the NVR's front panel or remote control to display the PTZ camera selection window.

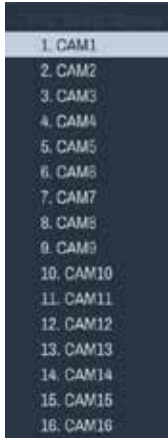

Select the camera you wish to control. The **P** icon will begin to flash on the selected camera's OSD window.

Use the **Arrow** buttons to pan and tilt the camera up, down, left, and right.

Use the **Camera 1** and **2** buttons to zoom in/out.

Use the **Camera 3** and **4** buttons to shift focus from nearby to far and vice versa.

You can also change the direction by dragging on the mouse.

Also, it's possible to use the mouse wheel to zoom in/out.



- Logging in with an account that has **PTZ Control Authority** is necessary in order to control PTZ cameras.
- A message will prompt if there is no PTZ camera displayed on the Live screen.
- Zoom in/out and shift focus using the **PTZ Control (ZOOM, FOCUS)** buttons on the remote control.
- To exit PTZ mode, press the **PTZ** button again.

Setting Up a PTZ Preset

While in PTZ mode, select the **VIEW** button on the remote control to display the **Set Preset** window and assign the current position as a preset.

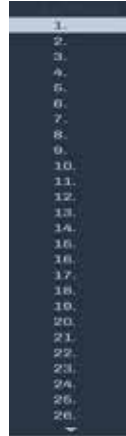

While in PTZ mode, select the **SAVE** button on the remote control to display the **Move to Preset** window. Select a preset to move the current PTZ camera to the selected preset's position.

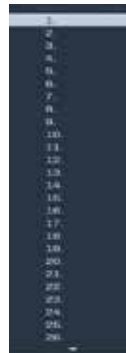

Advanced Settings

In PTZ mode, selecting a camera and then clicking **Menu** button loads the Advanced PTZ screen as shown below. You can load the Advanced PTZ screen also by pressing the **Play/Pause** button and then **SETUP** button on the front panel. This menu lists **Speed, Auto Pan,** and other advanced PTZ camera control options available for the camera. Options that are not available for the selected PTZ camera remain inactive.



- You can use the mouse to control PTZ cameras. Left-click on the mouse and drag to move the camera in the desired direction and use the mouse wheel to zoom in/out.

While in PTZ mode, place the mouse pointer close to the bottom edge of the screen to display the PTZ Tools window.



	PTZ Camera Pan and Tilt
	Zoom In/Out
	Focus Near / Far
	IRIS Open / Close

	One Push
	Set /
	Device Menu supported by the camera

- The exact PTZ protocol supported by the camera must be specified in order to use the NVR's PTZ controls.
- Drag and drop to reposition the PTZ Tools window.
- Select the icon to hide the PTZ Tools window.

Event Monitoring

When an event occurs, the NVR automatically displays the channel linked to the event and shows the icon on the system status area on the bottom left portion of the screen. To use the Event Monitoring feature, navigate to **Display Setup > OSD** and enable **Event Monitoring**. Event Monitoring remains in effect throughout the entire **Linked Recording Time**. After that, the NVR will return to the previous screen if a new event does not take place. Pressing the **Layout** or a **Camera** button before the end of the **Linked Recording Time** reverts the system to Live mode.

Covert Camera

Use this feature to assign **Covert Camera View** permissions.

Navigate to **Camera Setup > General** and designate cameras as **Covert 1** or **Covert 2**.

- Covert 1:** Hides images from the camera in Live mode but does indicate the camera's title and status via icons.
- Covert 2:** The camera is indicated as being inactive. Images from the camera are not shown. Camera title and status icons are not shown.

- Users that have a cover **Covert Camera View** are able to view both images from and status icons for all **Covert 1** and **Covert 2** cameras.

Context Menu Access

While in Live mode, press the remote control's  button and then the Menu button to display the Context Menu window. You can display the ContextMenu window also by pressing the **Play/Pause** button and then **SETUP** button on the front panel. Alternatively, right-click on the mouse to access the Context menu.

- **PTZ:** Access PTZ controls.
- **Zoom:** Zoom in.
- **Audio:** Enable/disable audio. (This function supports only in single screen.)
- **Color Control:** Select a channel to display its Color Control window. Adjust the selected camera's brightness, contrast, saturation, and hue settings.
- **Information:** Select a network channel to display information about the selected channel's device.
- **Edit Group:** Rearrange the split screen layout.
- **Camera Registration:** Activate Camera Registration mode.
- **Login/Logout:** Log into the account or log out of the account.

Edit Group

Edit Group lets you customize split screen pages in both Live and Search modes.

- 1 While displaying a split screen page, select the **Edit Group** option from the context menu. A yellow border is drawn around the page. Use the arrow buttons on the front panel or the mouse to select a different page.
- 2 Press a **Camera** button or select a camera after pressing the **Menu** button. Selected camera is then loaded on to the selected page. Repeat to assign other channels to the page.
- 3 Press the remote control's  button to exit Edit Group. Alternatively, press the **Menu** button and then select **Exit Group Edit** to exit.



Edit Group will terminate automatically after 15 seconds of inactivity.

Video Recording

Video recording will only take place if all the connections are made correctly as per information contained in Part 2 of this operation manual.

For more information on video recording settings, refer to the [Record Setup on page 42](#).

Panic Recording

Select **Live** or **Search** menu's Panic Recording  icon or press the **PANIC** button on the front panel or the remote control to commence panic recording on all registered cameras.

To stop Panic Recording, select the Panic Recording  icon or press the **PANIC** button again. If the **Panic Recording Duration** option under **Record Setup > General** has been configured, Panic Recording will automatically terminate after the specified duration of time has elapsed. For more information, refer to the [Record Setup on page 42](#).



- Panic Recording takes place irrespective of any recording schedule set up by the user.
- Panic Recording video profile from **Record Setup – General** applies to all Panic Recording videos.



Panic Recording will not take place if recording mode is not set to **Recycle** and the HDD has reached 100% of its capacity.

Audio Recording

If the Record Audio option under **Record Setup** > **General** has been enabled, the camera will record audio along with video. For more information, refer to the **Audio on page 63, Record Setup on page 42.**



Check your local laws and regulations on making audio recordings.

Video Recording Playback

You can play back video recordings by using mouse or remote control.



- Login with an account that has search permission is needed to playback video recordings.
- The initial video playback point in Search mode is the recording's last playback point or the end of the recording data.
- Audio playback of the selected recording is available in full screen mode only.
- Covert protection on cameras also applies to video recording playback.

All Channel Playback

- 1 Press the **Menu** button while in Live mode.
- 2 Select the Search Mode  icon and then select **Time-Lapse Search** or **Event Log Search**.
- 3 The selected search mode will be initiated.

For more information on data search, refer to the **Part 4 - Search on page 64.**

Remote Control Buttons during Playback

- 1 **Camera Button:** Displays the selected recording in full screen.
 - 2 **Zoom Button:** Allows you to zoom in on a specific area of the recording.
- Layout Button:** Cycle through screen formats.

Context Menu

While in Search mode, press the remote control's  button and then the **Menu** button to display the Context Menu window. Alternatively, right-click on the mouse to access the Context Menu.

- **Zoom:** Zoom in.
- **Audio:** Enable/disable audio. (This function supports only in single screen.)
- **Edit Group:** Rearrange the split screen layout.

Part 3 - Configuration

Menu Use

Information contained in this section (Menu Use) applies to all other instructions found throughout **Part 3 - Configuration**.

Login with an ID that has permission to access the setup menu is needed to access and make changes to the Setup menu.

- 1 While in Live mode, press the remote control's **SETUP** button or select Live menu > Setup using the mouse.



1	System Setup
2	Record Setup
3	Event Setup
4	Network Setup
5	Device Setup
6	Display Setup
7	Notification Setup
8	Camera Setup

- 2 Use the remote control's arrow buttons to select an option and then press the remote control's button or left-click on the option using the mouse.

- 3 Change the setting and then select **Apply** or **OK** to save the change.

To apply default settings, select the Default button located on the left bottom corner of the setup window.

Text Input via Virtual Keyboard

Use the remote control's arrow buttons to select a virtual keyboard key and then press the remote control's button or click on the key using the mouse.



	Toggle case.
	Deletes the character to the left of the cursor.
	Deletes the character to the right of the cursor.
	Converts keyboard.

Batch Assignment

Certain table-format menus such as the shown in the Record Setup on page 42 allow you to change the title value. In this case, changing the title value simultaneously changes all other entry values on the same row.

Mouse

Using a mouse makes it easier to configure the settings. A mouse lets you make selections faster and use its wheel to scroll through long menus. You can also use the mouse wheel to increase/decrease numerical values.

System Setup

Refer to the **Menu Use on page 35** for basic information on using the Setup menus.

General

This Setup menu contains general system options.



- **Site:** Used to enter a description about the system's installation site (no description by default). You can edit the information using the virtual keyboard.
- **System ID:** Used to identify the NVR apart from other NVRs. System ID is also used to control the NVR with the remote control.

The default System ID is 0 and can be changed to a value between 0 and 99. The System ID can also be entered using the virtual keyboard.

- **Language:** Choose a language.
- **Version:** Indicates the software version.
- **Upgrade:** Select to upgrade the system. Selecting Upgrade displays the USB search window. You will then be able to select an upgrade package and upgrade the system. Once the upgrade is complete, the NVR will reboot automatically.

If an upgrade attempt fails, an upgrade failure message will be displayed. Refer to **Error Code Types on page 78** for more details.

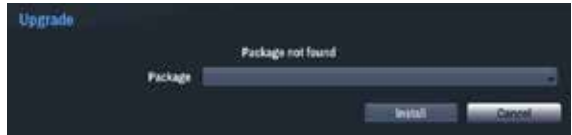

- **Setup:** Exports current NVR settings or imports existing settings.
- **Import:** Decide whether to import network settings as well. If you do not wish to change the current network settings, do not select **Include Network Setup**.

Selecting **Setup Import** does not change the settings below.

- Time-related settings (Date/Time, Time Zone, and Use Daylight Saving Time)
- Camera-related **Advanced Settings** settings
- Camera-related **Stream** settings (Only if the resolution is different from the camera in exporting)

- **Export:** Exports the current system settings to a storage device connected to the system's USB port. You can designate a **File Name** for the export file.

For USB flash memory devices, the NVR supports the FAT32 file format only.

- **Show System Log:** Displays a searchable list of 5,000 most recent system log entries. For more information on types of system log entries, refer to the **System Log Types on page 77**. The  icon appears next to log entries originating from a remote source. To export the system log, select the **Export** at the bottom of the screen and then designate a file name.



- ✓ In order to display the system_log.txt file, you must use the correct character encoding settings and use a fixed-width font.

- **Clear All Data:** Erases all recording data. Selecting **Clear All Data** displays a confirmation window. Select **Clear** to proceed.

- ✓
 - Before you perform **Clear All Data**, make sure you are not accidentally deleting important data. Erased data cannot be recovered.
 - **Clear All Data** does not affect the system log. Instead, the **Clear All Data** event will be added to the log.

- **System Shutdown:** Shuts down the system. When prompted, select **System Shutdown**.

- ✓ • The system will restart after changing the channel mode.

Date/Time



- **Date:** Used to change the system's date setting.
- **Time:** Used to change the system's time setting.
- **Date Format/Time Format:** Used to change the system's date and time formats.
- **Time Zone:** Used to designate the system's time zone.

- ✓ Refer to the map displayed on the screen and change the time zone using the mouse or the arrow buttons.

- **Use Daylight Saving Time:** Enables DST correction.
- **Time Sync.:** Select a time server for the system to synchronize with.

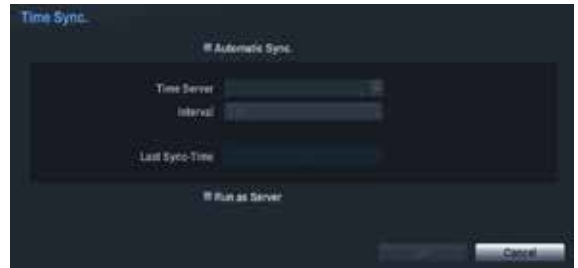

- 1 Select **Automatic Sync.**
- 2 Enter the **Time Server's** IP address or domain name or select  and then choose a server from the list of registered time servers.

- 3 Specify the server synchronization **Interval**.

- 4 Select **OK** to apply and exit.

- ✓
 - If you have configured the DNS Server setting under **Network - IP Address**, you can enter the time server's domain name instead of its IP address.
 - Selecting **Run as Server** sets the current NVR as a time server for other NVRs within the system.

- **Holiday:** Designate holidays. On specified holidays, recording takes place according to the holiday recording schedule specified under Record Schedule.

- 1 Select the + button at the bottom of the window.

- 2 Select a date.

- 3 Select **OK** to apply and exit.

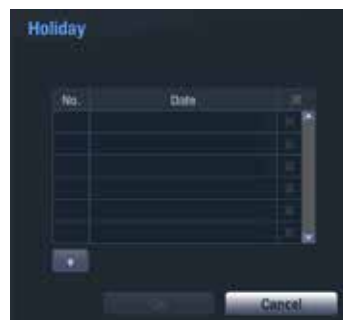

- ✓ Select the  icon to delete the existing holiday date.

User

Use this option to register users and assign permissions.



- 1 Select **+ Group** and enter a group name. A group name can be up to 15 characters in length.
- 2 Specify the group's permission settings. For more information on permission settings, refer to the [Group Permissions on page 39](#).

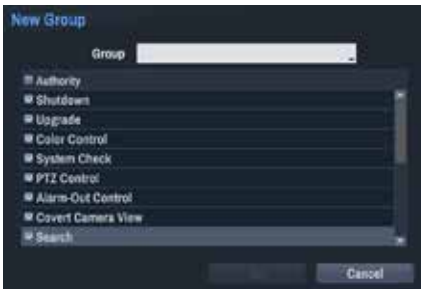

- 3 Select **+ User** and then enter a user name.



- 4 Select a group for the user and then enter a password. The password can be up to 16 characters in length and may include letters, symbols, and numbers.

- 5 Select **OK**.

- 6 Configure **Auto Login** and **Auto Logout** settings.

- 7 Select **Apply** or **OK** to exit.



- Group names, user names, and passwords can be entered using the virtual keyboard. For more information on using the virtual keyboard, refer to the [Text Input via Virtual Keyboard on page 35](#).
- To delete a registered user or group, select the icon on the right of the corresponding user/group. **Group Administrator** and **User admin** cannot be deleted.
- Select the icon next to **Group & User** on the top of the screen to delete all groups and users except **Group Administrator** and **User admin** simultaneously.
- A password entry is required to edit existing groups and users.
- **Group Administrator's** permissions cannot be changed.
- With the **User admin** account, only the password can be changed.
- When the system starts up, it will automatically log into the account designated under **Auto Login**.
- The system will automatically log out of the account if the duration of inactivity specified under **Auto Logout**.

Group Permissions

System Shutdown		May shutdown the system from the system menu.
Upgrade		May upgrade the system from the system menu (System Setup).
Color Control		May adjust each camera's brightness, contrast, saturation, and hue settings.
System Check		May view System Check results.
PTZ Control		May control PTZ cameras.
Alarm-Out Control		May reset in the event of an alarm-out. Alarm-outs can be reset by pressing the Alarm button on the device or selecting the Alarm-Out Control button on the remote program.
Covert Camera View		May access covert cameras in Live and Search modes.
Search	Clip Copy	The user who has permission for Clip Copy can perform Clip Copy. If the user does not have permission, Clip Copy is not allowed but only search is allowed.
Setup	System Time Change	May change the system's date and time settings.
	Data Clear	May clear data stored in the system.
	PTZ Setup	May configure PTZ settings.
	Alarm-Out Setup	May configure alarm-out settings.
	Covert Camera Setup	May configure covert camera settings.
	Record Setup	May configure recording settings.
	Setup Import	May import previously saved NVR settings.
	Setup Export	May export current NVR settings.

Storage

Use this option to configure storage settings.

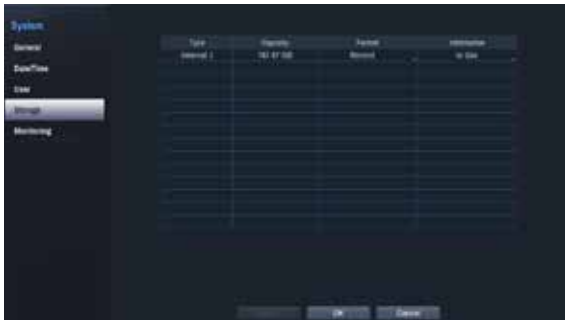

- **Type:** Indicates the type of the installed disk.
- **Capacity:** Indicates the disk's capacity.
- **Format:** If the disk has been formatted, indicates either **Record** or **Not Using**. If you have connected an unformatted storage device, the Use As value will be indicated as **Not Formatted**.
- **Information:** Indicates if the disk is being used for recording purposes. Disks that were used in different systems will show up as **Other**. Select **Information** to check the saved data's time information or select **Delete** to erase the data.



- Select **Format** to prepare the disk as a storage for data recording.
- Disks formatted with Use As set to **Not Using** will not be used for data recording.
- This NVR supports SATA2 and eSATA HDDs.

Monitoring

Use this option to configure Monitoring settings.

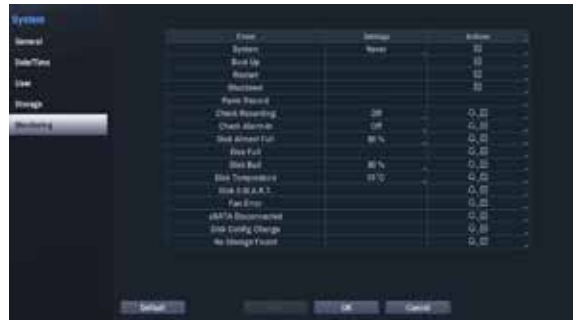

- **Settings:** Configure when and what the system should monitor for.
- **Actions:** Configure alarm-out (NVR alarm-out channel, NVR beep, camera alarm-out channel) and notification (email, LAN1 through 5, SNS, alert window) settings.

Monitoring Options

System	Define monitoring times. If self-diagnosis is not performed on a regular basis, the system will assume an error.
Bootup, Restart, Shutdown	Define bootup, restart and shutdown actions.
Panic Record	Define panic recording actions.
Check Recording	<p>The system will assume an error if the system has been scheduled to record normally but recording does not take place during scheduled intervals.</p> <p><input checked="" type="checkbox"/> Select Schedule On and then configure the days of the week, times, and monitoring interval. Select the + button on the bottom left of the screen to add a schedule. Select <input type="checkbox"/> to delete the schedule.</p> 
Check Alarm-In	The system will assume an error if the alarm-in status does not change during the specified monitoring interval while alarm-in is active.
Disk Almost Full	Generates an event if the disk reaches the specified capacity (80% to 99%).
Disk Full	Generates an event when all disks reach their maximum capacity.
Disk Bad	Generates an event when the specified percentage of the disk becomes damaged. Set to between 10% and 90% in 10% intervals.
Disk Temperature	Specify the threshold temperature. Once any disk reaches this threshold, the system will issue an alert.
Disk S.M.A.R.T.	Monitors disks that support S.M.A.R.T. and notifies the user if a disk error is detected.
Fan Error	Notifies the user when the fan inside the system malfunctions.
eSATA Disconnected	Notifies the user if an eSATA device becomes disconnected while in use.
Disk Config Change	It will be highlighted when the NVR reboots after the hard disk drive has been replaced.
No Storage Found	It will be highlighted when no hard disk drive has been connected.



- For system events, only an e-mail notification of actions can be selected.
- In order to use the Notify(Callback) feature, the NVR must be registered to the remote program on the receiving PC's end.

Record Setup

Refer to the **Menu Use on page 35** for basic information on using the Setup menus.

General

Configure general recording settings.



- **Recycle:** When the recording disks become full, the system overwrites existing data with new data, starting with the oldest first. If **Recycle** is disabled, recording will simply stop when the recording disks reach their maximum capacity.
- **Record Audio:** The camera will record audio along with video.
- **Event Record Dwell:** If linked recording is designated as an event-triggered action, recording takes place for the duration specified under this setting.
- **Auto Deletion:** Configure this option to delete recording data automatically after the specified number of days has elapsed. Select between 1 day and 999 day.



To disable Auto Deletion, select **Never**. If enabled, recording data will be stored on the NVR for the specified number of days and then deleted automatically. Expired recording data are deleted automatically at midnight and will be deleted even if the system reboots or the **Auto Deletion** setting has been changed.

- **Limit Time-Lapse Recording:** You can store event recording data for longer. If you do not wish to use **Limit Time-Lapse Recording**, select **Never**. This function is activated when data has been stored for longer than as configured because the recording disk has sufficient capacity and saves new data by overwriting **Time Lapse Recording** data that are older than as specified under Recycle mode.



- If the recording stored on the disk is shorter than the duration specified under **Limit Time-Lapse Recording**, the older of **Event Recording** or **Time Recording** data is deleted first.
- The system's recording time may change depending on recording quality, resolution, motion, and other configurations made by the user. The duration specified under **Limit Time-Lapse Recording** may not be guaranteed in certain situations.
- **Recording Failover Service:** If the network goes down, this feature will transfer temporary data stored in the camera's buffer to the NVR when the network goes online again.
- **Use Panic Recording:** Enable/disable Panic Recording.
- **Panic Recording Duration:** Disable Panic Recording automatically. Select between 5 mins and 1 hr. If you do not wish to disable the feature automatically, select **No Limit**.
- **Video Profile:** Select a recording profile value for Panic Recording.



Schedule



<Simple Mode>



<Advanced Mode>

Disabling **Schedule On** suspends schedule recording regardless of the schedule and displays the  icon on the upper left corner of each camera screen. Pressing the **Panic** button displays the  icon and commences panic recording.











Set Record Schedule mode as **Simple Mode** or **Advanced Mode**. **Advanced Mode** allows you to configure a unique recording schedule for each event. Select the  icon to delete a schedule.



- Changing the recording schedule mode suspends all active event-linked actions.
- Select the + button on the bottom left of the screen to add a schedule. Select **Day** to specify the **Day** setting or select **All**. Select **Scope** to specify the time frame.

Simple Mode Options

- **Mode:** Select **No Record**, **Time**, **Event**, or **Time & Event**.

<p>No Record</p>	<p>Unless the Panic button is pressed, no recording will take place during the scheduled time frames on the scheduled days.</p>
<p>Time</p>	<p>The  icon appears on the upper left corner of the screen. The  icon appears at scheduled times to indicate recording is in progress.</p>
<p>Event</p>	<p>The  icon appears on the upper left corner of the screen. The  icon appears when the specified event occurs to indicate recording is in progress.</p> <p><input checked="" type="checkbox"/> If Pre-Event is enabled, the  and  icons appear when recording is not in progress, or the  and  icons appear when an event occurs and recording is in progress.</p>
<p>Time & Event</p>	<p>The  icon appears on the upper left corner of the screen and recording commences as per the video profile selected for time under Setup. When an event occurs, the icon changes into  (red) icon and recording commences as per the video profile selected for events under Setup.</p>









- **Channel:** Select which cameras to apply the schedule to.
- **Settings:** Select to configure default recording profile values for Time Lapse and Event Recording modes.



Advanced Mode Options

Select to configure event types and video profiles.

- **Type:** Event-specific and time recording icons are as follows:

	Time Lapse (Time)		Audio Detection
	Alarm-In		Trip Zone
	Motion Detection		Tampering
	Video Loss		Text-In

- **Video Profile:** Configure the profile to use for recording.
 - **Dwell:** Specify how long to record for after a corresponding event occurs.
- Upper-tier schedule's settings apply to unconfigured channels.
- If multiple events take place on a specific channel and different **Video Profile** and **Dwell Time** settings apply, highest settings apply to all event-linked recordings.

Pre-Event

When an event occurs, enabling this option includes the specified duration prior to the event in the event-triggered recording.



- **No.:** Select which cameras to apply Pre-Event to.
 - **Video Profile:** Select a video profile for the recording.
 - **Dwell:** Specify the duration of pre-event recording data.
- If no event mode schedule exists in the schedule, a warning message prompting you to add an event mode schedule will be displayed.
- The warning message will appear even in **Time & Event** mode.

Event Setup (PLS-53xx)

Refer to the **Menu Use on page 35** for basic information on using the Setup menus.

- Available only for PLS-53xx over iNEX protocol!

Video-Analytics

Video-Analytics methods are Motion, Trip Zone, and Tampering.

Motion



- **No.:** Select which cameras to apply Motion Detection to.
- **Sensitivity:** Set daytime and nighttime sensitivity settings between 1 (Low) and 5 (High).



- **Zone:** Define the motion detection block.



Use the remote control's arrow buttons to move the block selection window up, down, left, and right. The selection window consists of 8 blocks per row. Select/deselect individual blocks using the **Camera** buttons. You can use the mouse to drag the zone and then select, clear, or reverse the selection.

From the zone selection screen, press the  button on the remote control or right-click on the mouse to open up the Zone Setup menu.



- **Select:** Confirm the block selection in the selection window.
- **Clear:** Clear the block selection in the selection window.
- **Reverse:** Clear the blocks selected within the selection window and select all unselected blocks within the selection window.
- **Select All:** Select all blocks.
- **Clear All:** Clear all block selections.
- **Reverse All:** Clear all selected blocks within the screen and select all unselected blocks within the screen.
- **OK:** Save the changes and exit the menu.
- **Cancel:** Exit the menu without saving the changes.
- **Min. Blocks:** Motion needs to be detected in more than the specified number of blocks in order to trigger a Motion Detection event. You may select a value between 1 and the number of blocks selected under **Zone** for daytime and nighttime, each.



- **Actions:** Specify which actions to take when motion is detected.
 - **Record:** Specify which cameras to begin linked recording on when an event occurs. If the schedule is set to Event or Time & Event mode, the selected cameras will begin linked recording when an event occurs.
 - **Alarm-Out:** Designate event-triggered alarm-out channels (each for the NVR and camera) and beeps.
 - **Notify:** Configure to be notified of events by Mail, LAN1 through 5, SNS, and/or Alert Window.
 - **PTZ:** Moves the PTZ camera to a specific preset position when an event occurs.

In order to use the Callback feature, the NVR must be registered on the remote program.

- **Motion Ignoring Time:** The system does not produce event log entries or issues remote notifications regarding motion detected during the specified time following the initial motion detection. Set a value between 1 sec and 5 secs or choose Never.

Motion Ignoring Time does not affect motion detection recording.

- **Daytime Setup:** Specify when daytime starts and ends. Adjust the time frame in 15-minute increments. Times outside the specified range will be assumed as nighttime by the system.

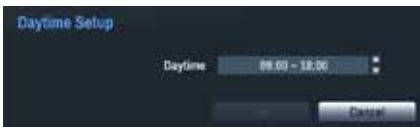

Trip Zone

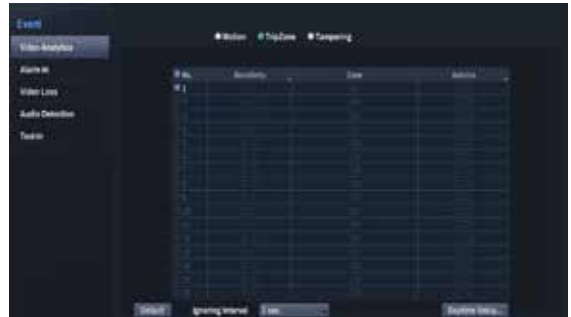

- **No.:** Select which cameras to apply Trip Zone to.
- **Sensitivity:** Set daytime and nighttime sensitivity settings between 1 (Low) and 5 (High).
- **Zone:** Define the motion detection block.

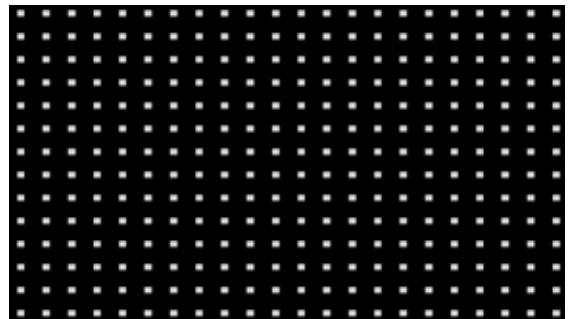

Use the remote control's arrow buttons to move the block selection window up, down, left, and right. The selection window consists of 8 blocks per row. Select/deselect individual blocks using the **Camera** buttons. You can use the mouse to drag the zone and then select, clear, or reverse the selection.

From the zone selection screen, press the  button on the remote control or right-click on the mouse to open up the Zone Setup menu.



- **Select:** Confirm the block selection in the selection window.
 - **Clear:** Clear the block selection in the selection window.
 - **Reverse:** Clear the blocks selected within the selection window and select all unselected blocks within the selection window.
 - **Select All:** Select all blocks.
 - **Clear All:** Clear all block selections.
 - **Reverse All:** Clear all selected blocks within the screen and select all unselected blocks within the screen.
 - **Trip Direction:** Define in which direction the motion has to occur in order for it to be considered an event. Select In for movements from outside the selection area in or Out for movements from inside the selection area out.
 - **OK:** Save the changes and exit the menu.
 - **Cancel:** Exit the menu without saving the changes.
- **Actions:** Specify which actions to take when Trip Zone is detected.
 - **Record:** Specify which cameras to begin linked recording on when an event occurs. If the schedule is set to Event or Time & Event mode, the selected cameras will begin linked recording when an event occurs.
 - **Alarm-Out:** Designate event-triggered alarm-out channels (each for the NVR and camera) and beeps.
 - **Notify:** Configure to be notified of events by Mail, LAN1 through 5, SNS, and/or Alert Window.
 - **PTZ:** Moves the PTZ camera to a specific preset position when an event occurs.
- In order to use the Callback feature, the NVR must be registered on the remote program.
- **Trip Zone Ignoring Interval:** The system does not produce event log entries or issues remote notifications regarding Trip Zone events detected during the specified time following the initial Trip Zone event. Set a value between 1 sec and 5 secs or choose Never.
- Trip Zone Ignoring Time does not affect Trip Zone recording.
- **Daytime Setup:** Specify when daytime starts and ends. Adjust the time frame in 15-minute increments. Times outside the specified range will be assumed as nighttime by the system.

Tampering



- **No.:** Select which cameras to apply Tampering to.
- **Sensitivity:** Set to between 1 (Low) and 5 (High).
- **Activation Time:** Specify how long tampering detection needs to last in order for it to be considered an event. Tampering detections that do not last for the specified duration of time will not be considered as events.
- **Actions:** Specify which actions to take when Tampering is detected.
 - **Record:** Specify which cameras to begin linked recording on when an event occurs. If the schedule is set to **Event** or **Time & Event** mode, the selected cameras will begin linked recording when an event occurs.
 - **Alarm-Out:** Designate event-triggered alarm-out channels (each for the NVR and camera) and beeps.
 - **Notify:** Configure to be notified of events by Mail, LAN1 through 5, SNS, and/or Alert Window.
 - **PTZ:** Moves the PTZ camera to a specific preset position when an event occurs.

In order to use the Callback feature, the NVR must be registered on the remote program.

- **Use Ignoring Time:** Select **Time Setup** to specify the tampering detection ignore time. Tampering detection will be disabled during the specified time frame.

Alarm-In



- **No.:** Enable / disable alarm-ins.
 - This option includes both local and network camera alarm-ins. 1 through 16 are network camera alarm-ins, whereas 17 through 20 are local alarm-ins.
- **Title:** Use the virtual keyboard to enter titles.
- **Type:** Change the alarm-in type.
- **Actions:** Specify which actions to take when Alarm-In is detected.
 - **Record:** Specify which cameras to begin linked recording on when an event occurs. If the schedule is set to Event or Time & Event mode, the selected cameras will begin linked recording when an event occurs.
 - **Alarm-Out:** Designate event-triggered alarm-out channels (each for the NVR and camera) and beeps.
 - **Notify:** Configure to be notified of events by Mail, LAN1 through 5, SNS, and/or Alert Window.
 - **PTZ:** Moves the PTZ camera to a specific preset position when an event occurs.

In order to use the Callback feature, the NVR must be registered on the remote program.

- Select **Panic Record** to specify which alarm-in channels to use. Panic Record commences when the corresponding alarm-in occurs and terminates when the alarm-in is deactivated.

Video Loss



- **Actions:** Specify which actions to take when a Video Loss event occurs.
 - **Record:** Specify which cameras to begin linked recording on when an event occurs. If the schedule is set to **Event** or **Time & Event** mode, the selected cameras will begin linked recording when an event occurs.
 - **Alarm-Out:** Designate event-triggered alarm-out channels (each for the NVR and camera) and beeps.
 - **Notify:** Configure to be notified of events by Mail, LAN1 through 5, SNS, and/or Alert Window.
 - **PTZ:** Moves the PTZ camera to a specific preset position when an event occurs.

In order to use the Callback feature, the NVR must be registered on the remote program.

Audio Detection (PLS-53xx)

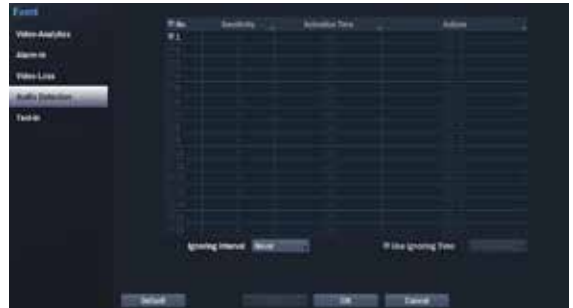

- Available only for PLS-53xx over iNEX protocol!
- **No.:** Select which cameras to apply Audio Detection to.
- **Sensitivity:** Set to between 1 (Low) and 5 (High).
- **Activation Time:** Specify how long audio detection has to last in order for it to be considered an event. Audio detections that do not last for the specified duration of time will not be considered as events.
- **Actions:** Specify which actions to take when audio detection events occur.
 - **Record:** Specify which cameras to begin linked recording on when an event occurs. If the schedule is set to Event or Time & Event mode, the selected cameras will begin linked recording when an event occurs.
 - **Alarm-Out:** Designate event-triggered alarm-out channels (each for the NVR and camera) and beeps.
 - **Notify:** Configure to be notified of events by Mail, LAN1 through 5, SNS, and/or Alert Window.
 - **PTZ:** Moves the PTZ camera to a specific preset position when an event occurs.

In order to use the Callback feature, the NVR must be registered on the remote program.

- **Ignoring Interval:** The system does not produce event log entries or issues remote notifications regarding audio detected during the specified time following the initial audio detection. Set a value between 1 sec and 5 secs or choose **Never**.
- **Use Ignoring Time:** Select **Time Setup** to specify the audio detection ignore time. Audio detection will be disabled during the specified time frame.

Text insertion (POS systems)



- **Setup:** Configure text-in devices.

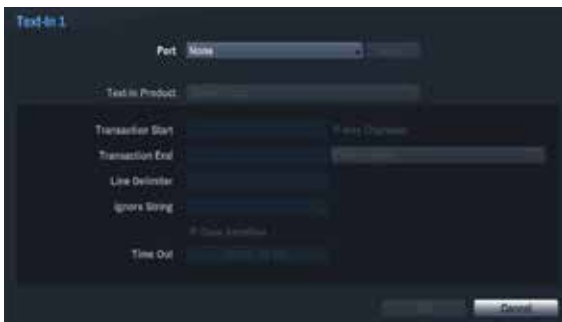

- It's possible to batch configure all text-in devices with the exception for port settings.
 - An influx of large amounts of text-in data from multiple channels can hinder system performance.
- **Text-In Product (e.g. NPC II):** The setup window is updated so that the portion below the port setting matches the corresponding text-in device. Displayed screenshot illustrates Generic Text settings.
- **Transaction Start:** Once **Transaction Start** has been designated, the system will recognize the specified string as the beginning of a transaction. You can choose the Any Character setting. Under this setting, any character will trigger the system into recognizing the start of a new transaction.
- **Transaction End:** Once **Transaction End** has been designated, the system will recognize the specified string as the end of a transaction. Select **0 more line(s)** next to Transaction End and specify a value between 1 and 10. The system will recognize the specified Transaction End string plus the number of lines as being the end of a transaction.

- **Line Delimiter:** Designate a string to mark the end of a line. You can enter control strings by selecting  and then entering ^, followed by a letter. For example, Carriage Return is ^M and Line Feed (new line) is ^J.
- **Ignore String:** Specify a string to ignore from transaction records.
- **Case Sensitive:** Ignores case in strings designated under **Transaction Start, Transaction End, Line Delimiter,** and **Ignore String.**

Case Sensitive does not apply to control strings.

- **Time Out:** Once **Time Out** has been enabled, the system will assume the end of a transaction if no new string is entered within the specified duration of time. Select between 5 secs and 15 mins.

Selecting RS-232, USB-Serial 1 through 8, or LAN 1 through 16 as the port activates the Port Setup button. Select **Setup** and configure the **Baud Rate, Data Bit, Stop Bit,** and **Parity** settings.

- If any one of LAN1 through 16 has been selected as the port, select the Port Setup button and configure the network port setting.
 - If using a USB-serial port, the Text-In feature may malfunction if the USB cable is removed while the system is in operation.

- **Title:** Designate a name for the text-in device.
- **Actions:** Specify which actions to take when text-in is detected.
 - **Record:** Specify which cameras to begin linked recording on when an event occurs. If the schedule is set to Event or Time & Event mode, the selected cameras will begin linked recording when an event occurs.
 - **Alarm-Out:** Designate event-triggered alarm-out channels (each for the NVR and camera) and beeps.
- **Notify:** Configure to be notified of events by Mail, LAN1 through 5, SNS, and/or Alert Window.
 - **PTZ:** Moves the PTZ camera to a specific preset position when an event occurs.

In order to use the Callback feature, the NVR must be registered on the remote program.

Network Setup

Refer to the **Menu Use on page 35** for basic information on using the Setup menus.

General

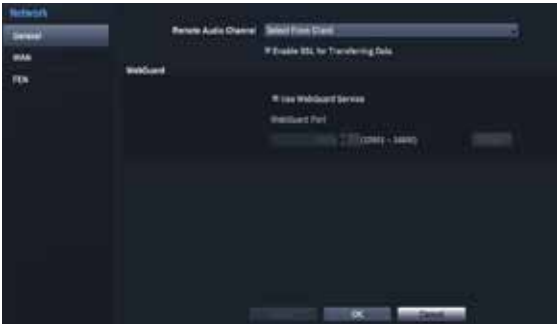

- **Remote Audio Channel:** Transmits the selected channel's audio to the remote program. Select **Select From Client** to stream audio of the channel selected on the remote program.

Audio skipping and sync issues can occur under poor network conditions.

- **Enable SSL for Transferring Data:** Applies SSL (Secure Sockets Layer) protection on remote viewing and recording data transmissions.

If using the SSL feature, it will not be possible to connect to the NVR from a remote program or a network keyboard that does not support SSL.

- Changing the SSL setting temporarily severs all remote connections to the NVR in order to apply the change.
- This product contains content developed by OpenSSL Project for use in Open SSL Toolkit (<http://www.openssl.org/>).

- **WebGuard:** If you wish to use WebGuard, select **WebGuard - Use WebGuard Service**. Select **WebGuard - WebGuard Port** and choose a port number between 12001 and 14000. The port number can also be entered using the virtual keyboard. For more information on WebGuard, refer to the **Part 5 - WebGuard on page 72**.

WAN

Designate the IP address type as Manual or **DHCP**. In the Appendix under **Recommended Network Setups** you can find further information on the WAN setting.

Manual



- Set **Type** to Manual.

Manual lets you configure related settings manually. Configure **IP Address**, **Gateway**, and **Subnet Mask** settings manually using the remote control's arrow buttons.

- **DNS Server:** Enter the DNS server's IP address. The IP address can also be entered using the virtual keyboard.
- **Remote Port:** The port used by the remote program to connect to the NVR. Choose a value between 8000 and 12000. The port number can also be entered using the virtual keyboard.
- **Remote Callback:** Set the port number using for remote callback. The port number can also be entered using the virtual keyboard.
- **Ping Test:** Select to test the current WAN settings you made.

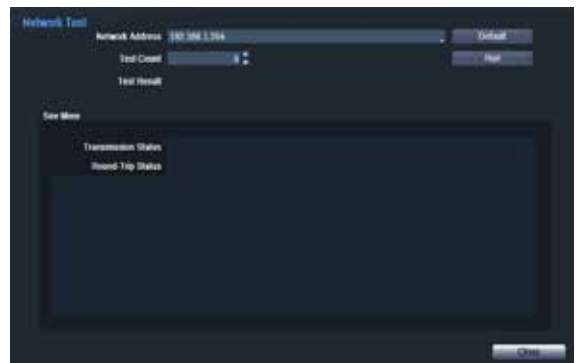

Part 3 - Configuration

- 1 Enter the IP address of the NVR.
- 2 Adjust the frequency of the ping test.
- 3 Select **Run** to do the test. The test result is displayed.
- 4 Select **Close** to exit.

- If using a firewall, select Change Port to change the port number to one that is permitted by the firewall.
- Changing the port temporarily severs the NVR's remote connection.

Remote point IP and port settings on the remote program must also be changed in order for it to connect to the NVR.

- To use the UPnP (Universal Plug and Play) feature, select **Use UPnP**. If using an IP router (or NAT), UPnP service allows the device to automatically forward the port to the NVR.

- This port is used to access a port that has a private IP address.
- In order to use the UPnP service, the IP router (or NAT) must support UPnP port forwarding and have the relevant options enabled.
- Port number cannot be changed with **Use UPnP** selected.

- **Status:** Indicates the number of the port forwarded by the IP router (or NAT) to the NVR via UPnP service.

DHCP



Select **DHCP** and then **Save** to retrieve IP address and other network settings automatically from the DHCP server. Once the network settings have been retrieved, the NVR's current IP address is displayed in the IP Address field.

- It may not be possible to retrieve the IP address if there is no DHCP server. If this is the case, contact your network administrator.
- With DHCP, the NVR's IP address might change with each startup.

There is a limit to the number of users allowed to connect remotely at the same time. Contact the service center for more information.

FEN

If using a dynamic IP address, FEN service makes it easy to connect to the NVR from a remote program without having to configure dynamic IP or router settings.

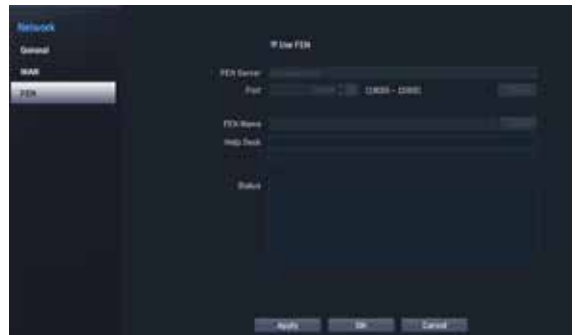

- **Use FEN:** Check if you wish to use FEN service.
- **FEN Server:** Enter the FEN server's IP address or domain name.

If you have configured the DNS Server setting under **Network - IP Address**, you can enter the FEN server's domain name instead of its IP address in the **FEN Server** field.

- **Port:** Specify the FEN server's port number.

If using an IP router (or NAT), port configuration and other network functions will depend on the usage method of the IP router (or NAT).

Device Name: After entering the NVR name you wish to register on the FEN server, check and register the entered name. This is a unique NVR name that will be registered on the FEN server.

- You will not be able to save FEN settings unless you click on the Check button next to the NVR Name field and check the entered name's availability.
- You will be prompted with an error message if you do not enter NVR name or enter a name already registered to the FEN Server.
- If the device name contains the #, \, and/or % symbol, it might not be able to connect to the NVR from the WebGuard program.
- **Status:** Used to check the status of the device being registered to the FEN server.

Select **Save** after making changes to register the NVR's name to the FEN server.

- If FEN has been configured correctly, the FEN server's help desk information will be displayed in the **Help Desk** field the next time you access the FEN Setup screen.

Device Setup

Refer to the Menu Use on page 35 **Menu Use on page 35** for basic information on using the Setup menus.

Alarm-Out



Select the + icon at the bottom left corner of the screen to add a schedule.

You can apply different schedules for different **Days** of the week.

Select to delete the schedule.

- **Dwell Time:** Select a value between 5 secs and 15 mins as the alarm-out duration.
- **Title:** Designate a name for the alarm-out.
- **Range:** Change the schedule time frame.
- **Mode:** Select **Event**, **On**, or **Off**.

Event	Generates an alarm-out when an event occurs.
On	Alarm-out is always on.
Off	Alarm-out is always off.

- **Channels:** Configure alarm-out port and beep settings.

Display Setup

Refer to the **Menu Use on page 35** for basic information on using the Setup menus.

OSD

Show OSD (On Screen Display) information on the bottom of the screen.



Status

- **Date** and **Time**: Displays the date and time.
- **Remote Control**: Displays remote control receptivity.
- **Free Space**: Displays whether or not the NVR is in the recycle mode, and displays the available storage space when not in the recycle mode.
- **User Name**: Displays the current user logged in.
- **Background Panel**: Displays background panel at the bottom of the screen in black.

Camera

- **No.:** Displays the camera number on the upper left corner of the camera screen.
- **Title:** Displays the camera name on the upper left corner of the camera screen.
- **Record:** Displays recording and schedule icons.
- **Audio:** Displays the  icon on channels generating audio.
- **PTZ:** Displays the **P** icon on PTZ cameras.
- **PTZ Zoom:** Displays the zoom magnification (e.g. x2, x3, etc.)

- **Text-In:** Displays strings received from text-in devices. Select **Display Dwell** and specify how long to display the text-in string. Text-in strings are shown on the single screen only.
- **Zoom:** Displays a zoomed in state.
- **Network:** Displays the icon when the unit is connected to a network via Ethernet.
- **Freeze & Sequence:** Displays freeze and sequence icons.
- **Screen Group:** Displays the current screen's group.

Main Monitor

Configure monitor-related settings.



- **Mode:** Select **Full Sequence** or **Cameo Sequence**.
 - **Interval:** Select between 3 secs and 2 mins. For more information on Sequence, refer to the **6 Sequence on page 28**.
 - **Event Monitoring On:** With Event Monitoring enabled, video feed from the camera configured to start recording when an event occurs is shown on the screen. For more information on Event Monitoring, refer to the **Event Monitoring on page 32**.
 - **Manual Configuration:** Set the resolution manually regardless of the resolution supported by the monitor.
 - **Resolution:** Select 1920 x 1200, 1920 x 1080, 1680 x 1050, 1600 x 1200.
- Supported resolutions may be restricted depending on the monitor.
- We recommend that you use 1920 x 1080 resolution.

Notification Setup

Schedule

Select the + icon at the lower left corner of the screen to add a notification schedule.



- **Day:** Add different schedules for different days of the week.
- **Range:** Change the event notification time frame.
- **Notify:** Select which notifications to generate when an event occurs. Select **Mail, LAN 1 through 5, SNS,** and/or **Alert Window.**

- In order to use the **Notification (Callback)** feature, the NVR must be registered on the remote program.
- Select the icon to delete the existing schedule.

- **Summary Email Interval:** Transmit event summary emails to a remote destination at specified intervals.

Callback

Configure Callback settings.



Enter the IP address of the receiving server and set **Retry** to between 1 and 10 in case of connection failure.

Mail

Configure Mail settings.



Select the + icon at the bottom left corner of the screen to add a mail account.

Select **Recipient** and then enter the mail address and server information.



- The recipient's mail address must be in the correct email format and contain the @ symbol.

Part 3 - Configuration

Select the  icon to attach event recordings to outgoing mails.

Select the  icon to delete the account.

Select **MP4 Clip** to attach event recordings to outgoing mails.

- The event recordings generated by a camera can be attached only. Select the **MP4 Clip** option at the bottom to attach .mp4 video clips.

SMTP Setup

Select **SMTP Setup** at the bottom right corner of the screen to configure an SMTP server.

- 1 Select the SMTP server **Type**.
- 2 Enter the **SMTP Server's** IP address or domain name and then configure the **Port** and **Sender** settings.



Default SMTP server port number is **25**. Select **Test** to send out a test mail using the current settings. Select **Use SSL/TLS** to use an SMTP server that requires SSL connections.

- If you have configured the DNS Server setting under **Network - IP Address**, you can enter the SMTP server's domain name instead of its IP address in the **SMTP Server** field.
- Address entered under **Sender** must be in the correct email format and include the @ symbol.

If user authentication is required by the SMTP server, select **Use** and then enter the **User** and **Password** information.



- 3 Select **OK** to apply and exit.

- This product contains content developed by OpenSSL Project for use in Open SSL Toolkit (<http://www.openssl.org/>).

SNS

This option enables the NVR to send out SNS messages.



The SNS (Social Network Service) feature sends out event-related messages to designated Twitter accounts. Select the + icon at the bottom left corner of the screen to add an SNS account. Select the  icon on the right side of the list to remove the SNS account.

Enter the **User Name** and **Password** information.



- Messages may not be transmitted successfully due to limitations in Twitter's services.

Camera Setup

Refer to the **Menu Use on page 35** for basic information on using the Setup menus.

General

Enable/disable the covert view and rename cameras.

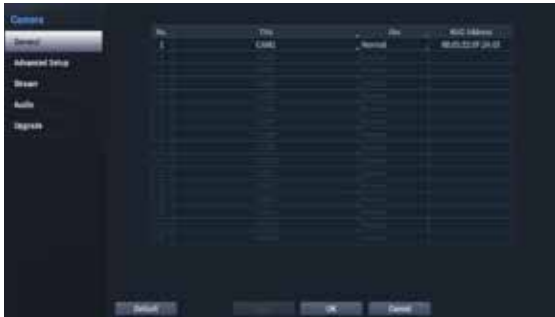

- **Title:** Edit the camera's name.
- **Use:** Set the camera as **Normal**, **Covert 1**, or **Covert 2**.

Live images and video recordings from cameras that have been set as **Covert 1** or **Covert 2** will not be available to users who do not have covert camera access. Setting a camera as **Covert 1** hides its images but does display OSD information about the camera. Setting a camera as **Covert 2** hides its images as well as ODS information about the camera as if it has been deactivated completely.

Advanced Setup (PLS-53xx)

Configure security and other advanced camera settings.



- **Video:** Adjust the camera image sensor settings such as white balance and exposure. Configuration options may differ depending on the camera model.
- **Privacy Masking:** Enable/disable and configure privacy masking for the camera.
- **SSL:** Set the camera's security level as **Unavailable**, **Standard**, **High**, or **Very High**. **Standard**, **High** and **Very High** settings apply SSL (Secure Sockets Layer) protection to the camera.
- **Mode:** Select a resolution mode. It is supported by analog cameras only.
- **PTZ:** If using RS-485-compliant camera, configure it for use in PTZ Mode.



- **PTZ Product:** Choose to select the model of installed PTZ device.
- **ID:** Choose to assign an ID to each PTZ device.
- Choose to set up **Baud Rate**, **Data Bit**, **Stop Bit** and **Parity** of the connected device.



Refer to the PTZ device manufacturer's instructions for the proper settings.

✓ Types of configuration options shown vary depending on the PTZ functions supported by the camera.



✓ Numbers shown below Preset, Scan, Pattern, and Tour indicate the numbers of configured functions.

① Preset



- Use the buttons below to choose a preset position.
 - Directional Buttons (⬅️ ⬆️ ⬇️ ⬅️ ➡️ ⬆️ ⬇️ ⬆️): Used to tilt and pan the camera.
 - Zoom (⊕ ⊖): Zoom in and out.
 - Focus (🔍): Adjust camera focus to far or near.
 - Speed: Specify the camera's panning and tilting speed.

- **Set:** Choose a preset number and then enter a name. This saves the current preset under the specified preset number and name.
- **Go to:** Select a preset from the list and then click Go to to move the camera to the selected preset position.
- **Edit:** Used to change the selected preset's name.
- **Remove:** Used to remove the selected preset.

② Scan

Used to set up a profile for moving the camera between two points. At least two presets must be available in order to use the scan feature.



- **Set:** Used to set up a scan profile.
 - **Name:** Enter a name for the scan profile.
 - **Start/Stop:** Specify which presets to use as start and stop points.
 - **Dwell Time (sec.):** Specify how long the camera will dwell at start and stop positions.
 - **Speed/Direction:** Specify scanning speed and direction.
- **Test:** Select a scan profile and then click Test to test it.
- **Edit:** Used to edit the selected scan profile.
- **Remove:** Used to remove the selected scan profile.

③ Pattern

Used to set up a pattern profile for the camera to follow along.



- **Start recording:** Select a pattern number, enter a name for the pattern, and then click **OK** to save the pattern. Move the camera using directional, zoom, and focus buttons and then click **Stop recording** to save the pattern profile. You can record up to two minutes of movement.
 - Directional Buttons (⬅️ ⬆️ ⬇️ ⬅️ ➡️ ⬇️ ⬇️ ⬆️): Used to tilt and pan the camera.
 - **Zoom** (⊕ ⊖): Zoom in and out.
 - **Focus** (🔍): Adjust camera focus to far or near.
 - **Speed:** Specify the camera's panning and tilting speed.
- **Test:** Select a pattern profile and then click Test to test it.
- **Edit:** Used to edit the selected pattern profile.
- **Remove:** Used to remove the selected pattern profile.

④ Tour

Used to set up a tour profile of multiple functions in a designated sequence.



- **Set:** Used to set up a tour profile.

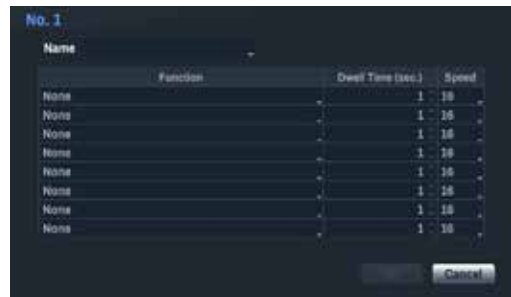

- **Name:** Enter a name for the tour profile.
- **No.:** Indicates the order of the function in the tour sequence.
- **Dwell Time (sec.):** Specify how long to perform the selected function for.
- **Speed:** Specify the preset speed.
- **Test:** Select a tour profile and then click Test to test it.
- **Edit:** Used to edit the selected tour profile.
- **Remove:** Used to remove the selected tour profile.

- Select **Apply** after setting up a preset, scan, pattern, or tour profile to see images from the concerned camera on the left side of the screen. Selecting **Apply** or **OK** displays a popup screen that indicates whether the profile has been set up successfully.

- ⑤ **Home Position:** Specify the camera's home position.
 - **Default:** Uses the factory-default position as the camera's home position.
 - **Custom:** Uses the user-defined position as the home position.
- Select **Set** to change the home position.
- ⑥ **Auto Run:** Specify which action to take if the camera has not been controlled for the specified duration of time.
- ⑦ **Auto Pan:** Specify the camera's panning direction. When Auto Pan is selected from a remote program, the camera pans in the direction selected here.

- ⑧ **Auto Flip:** Automatically flips the image when the camera tilts past 90° to prevent the objects from appearing upside down.
 - **Digital:** Flips the image left to right or top to bottom.
 - **Mechanical:** Automatically pans or tilts the camera.
 - **Off:** Disables Auto Flip.
- ⑨ **Tilt-Range:** Specify the camera's tilting range.
- ⑩ **Restore:** Specify whether to restore the camera to its last position or function. Enabling this option restores the camera to its last position or function after being restarted.

Privacy Masking Options

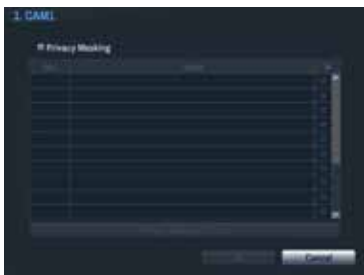

Select **Name** to rename the privacy masking area. Select the icon to delete the existing privacy masking area. Select **Privacy Masking Setup** to display additional privacy masking area options. You can drag on the area with the mouse to resize it or add up to 16 different areas.

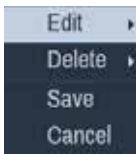

- **Edit:** Rename the selected privacy masking area.
- **Delete:** Delete the selected privacy masking area.
- **Save:** Save the changes and exit the privacy masking area options screen.
- **Cancel:** Exit the privacy masking area options screen without saving the changes.

Image Sensor Options

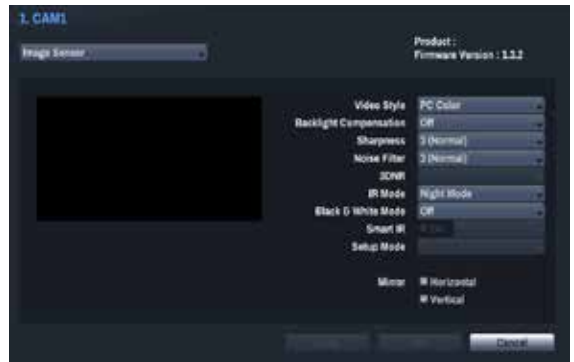

- **Title, Product, Firmware Version:** Displays the camera title, model name and firmware version.
- **Video Style:** Select **TV Color** or **PC Color**.
- **Backlight Compensation:** Enable/disable Backlight Compensation. If enabled, objects are exposed brighter in backlit situations.
- **Sharpness:** Adjust the sharpness level. Adjust the contours to make the images look sharper. Increasing the value raises the sharpness level, but using too high a value can result in unwanted noise.
- **Noise Filter:** Select the noise filter level. Noise filter can reduce the noise in images taken under low-lighting conditions. Increasing the value reduces the noise, but using too high a value can result in blurry images.
- **3DNR :** Enable/disable 3DNR (3D Noise Removal). 3DNR reduces background noise in images taken under low-lighting conditions. 3DNR does not produce blurry images like Noise Filter but can result in ghosting.
- **IR Mode:** **IR Mode** blocks out the infrared spectrum. You can ensure clear images at all times by blocking out the infrared spectrum in high-lighting conditions and allowing the infrared spectrum to pass through in low-lighting conditions.
 - **Daytime Mode/Nighttime Mode:** Enable/disable **IR Mode**.
 - **Auto:** Allow the system to enable/disable **IR Mode** automatically.
- **Black & White Mode:** Display the images in greyscale for greater clarity in low-lighting conditions.
 - **On/Off:** Enable/disable Black & White Mode.
 - **Auto:** Allow the system to enable/disable Black & White Mode automatically.

- **Smart IR:** Adjust the IR LED's brightness level. Select On to allow the system to adjust the brightness level automatically. Deselect On to select a brightness level manually between 0% (darkest) and 100% (brightest).
- **Setup Mode:** Select desired setup mode between **Normal** and **Number-Identification**. In **Number-Identification** mode, when a certain area of images is too bright due to backlight under low lighting conditions and it causes the other area to be too dark, this function provides the other area of images brightly and clearly by blocking the backlight in the certain area. Dark parking lot entrances and gas station entrances at night, for example (Local Exposure compensates for the bright light coming from incoming vehicle headlights and makes it possible to see the license plates). When setting to the **Number-Identification** mode, some option settings will be adjusted automatically, and you cannot change them as long as the Setup Mode is not changed.
- **Mirror:** Select **Horizontal** or **Vertical** to flip the image horizontally and/or vertically.

- Select **Apply** after setting up a camera to see images from the concerned camera on the left side of the screen. Selecting **Apply** or **OK** displays a popup screen that indicates whether the camera has been set up successfully or not.

White Balance Options

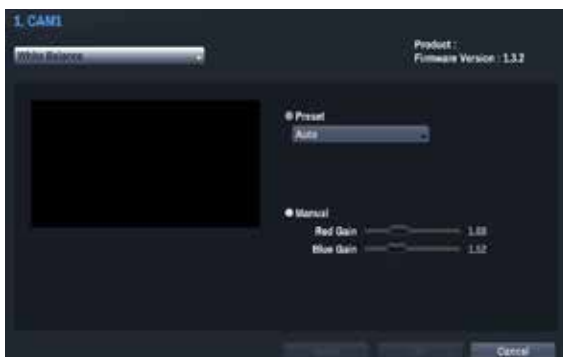

- **Preset:** Use preconfigured white balance settings.
 - **Auto:** Allow the system to adjust the white balance automatically. The system will assess the lighting conditions and adjust the white balance automatically.
 - **Incandescent - Fluorescent Cold:** Select a lighting type to apply the appropriate white balance.

- **Manual:** Adjust the white balance manually. Adjust Red and Blue gain values. Greater the value, greater the intensity of the corresponding color.

- Select **Apply** after setting up a camera to see images from the concerned camera on the left side of the screen. Selecting **Apply** or **OK** displays a popup screen that indicates whether the camera has been set up successfully or not.

Exposure Options

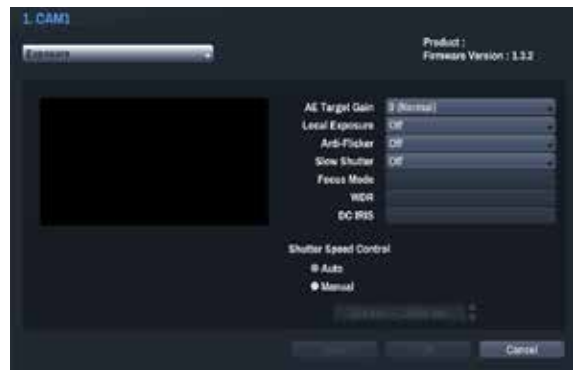

- **AE Target Gain:** Specify exposure compensation's target gain. Exposure is compensated automatically based on the specified target gain. Higher the gain, brighter the images.
- **Local Exposure:** Activate Local Exposure. Use Local Exposure on images that appear too dark due to backlighting conditions and on images containing over-exposed sections. Greater the value, clearer the image. e.g.) Dark parking lot entrances and gas station entrances at night (Local Exposure compensates for the bright light coming from incoming vehicle headlights and makes it possible to see the license plates).
- **Anti-Flicker:** If the lights in the area where the camera is located use alternating current, specify the frequency of the lights to minimize flickering. Matching the frequencies can eliminate flickering completely. (NTSC: 60Hz, PAL: 50Hz).
- **Slow Shutter:** Activate Slow Shutter. The slow shutter mode functions only under low lighting conditions. When the slow shutter mode is enabled, images are displayed bright even under the low-lighting conditions. There may be a difference in the way it functions depending on the camera model. See the camera user's manual for details.

- **Focus Mode:** Used to change the focus movement format as Auto/Manual/Semi-Automatic. It may not be supported depending on the device.
- **WDR:** Disables or enables the WDR (Wide Dynamic Range). When the very dark and very bright areas exist simultaneously on the screen, WDR allows you to recognize the both areas.
- **IRIS:** Select the lens IRIS type. If a manual IRIS lens is mounted on the camera, select **Manual**. If a DC-type auto IRIS lens is mounted, select **DC IRIS**.
- **Shutter Speed Control:** Adjust Shutter Speed. This option is available only when **Anti-Flicker** and **Slow Shutter** are both set to **Off**.
 - **Auto:** The system will assess the lighting conditions and adjust the shutter speed automatically.
 - **Manual:** Use the slider to select the desired shutter speed. Select the most suitable minimum and maximum shutter speeds for the lighting conditions in the area where the camera is located. (1/30 to 1/8000)

Select **Apply** after setting up a camera to see images from the concerned camera on the left side of the screen. Selecting **Apply** or **OK** displays a popup screen that indicates whether the camera has been set up successfully or not.

Miscellaneous

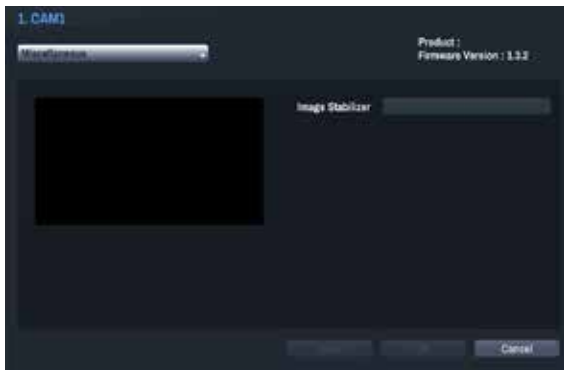

- **Image Stabilizer:** Activate Image Stabilizer. The Image Stabilizer reduces blurring caused by camera shake that results from external conditions such as the wind.

Stream



Configure the camera's live and recording resolution, picture quality and ips speed settings.

- **Camera Channels:** It's possible to configure a unique stream for each camera.
- **Apply:** Apply the stream settings of the camera selected under Camera Channel to a different camera.
- **Stream:** Configure **Stream 1**, **Stream 2**, or **Stream 3**.
 - **Resolution:** Select a resolution supported by the camera. Maximum available resolution is chosen automatically based on the selected streams.
 - **Quality:** Select **Very High**, **High**, or **Standard**. You can assign different Quality settings to different cameras.
 - **ips:** Select a value between 1 and 30. Maximum ips is determined automatically based on the selected the stream.
- **Live Video Profile:** Check the current Live streams. It allows you to select the streams according to split screen.
- **Record Video Profile:** Display 3 record video profile.
- **Remote Setup:** Set up the remote streams.

Audio (PLS-53xx)

Configure audio recording settings for all cameras simultaneously.

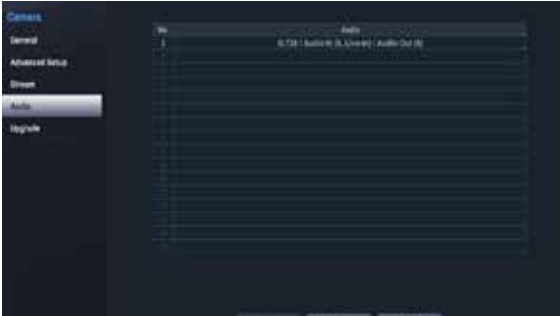

- **Audio Codec:** Select an audio codec. (G.711 u-Law, G.711 a-Law or G.726)
- **Audio In:** Select an audio input source (microphone or line-in) and then adjust the volume.
- **Audio Out:** Adjust the volume.
- **Associated Audio In:** Associates the selected audio channel with the camera. It is supported by analog cameras only.

 Cameras do not feature built-in audio amplifier units and therefore require the user to purchase a speaker system with a built-in amplifier separately.

Upgrade (PLS-53xx)

Select **Firmware Upgrade** to display the USB search window.

Select the corresponding upgrade package from the storage device connected to the NVR's USB port.

After selecting an upgrade package, select Apply to upgrade the camera.

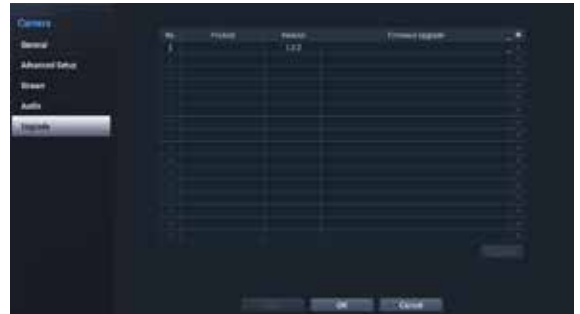

- If an upgrade attempt fails, an upgrade failure message will be displayed. Refer to **Error Code Types on page 78** for more details.
- The camera will reboot after the upgrade and then reconnect automatically.
- Current software version is not checked when upgrading a network camera.

Part 4 - Search

Time-Lapse Search

While in Live mode, select the **Search Mode**  icon and select **Time-Lapse Search** or **Event Log Search**.

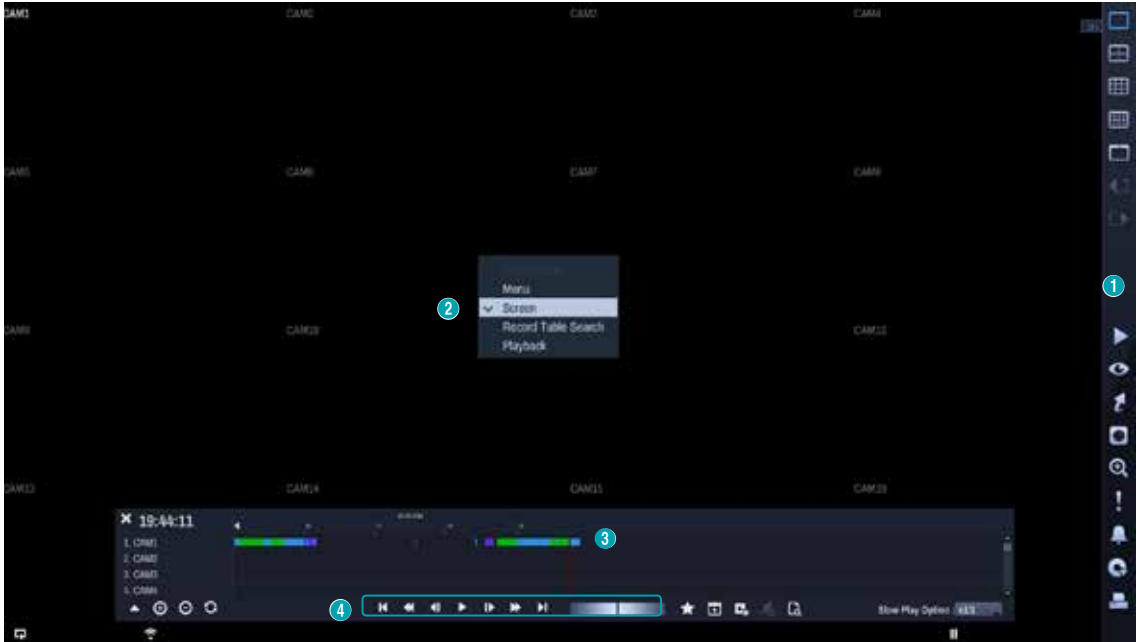

- 1 Select **MENU** button on the remote control while in Search mode to display a menu from which you can select **Control Area**.
- 2 Press **MENU** button once more to move the **Control Area**.
- 3 In 2 seconds after moving the **Control Area**, the **Control Area** becomes selected and the corresponding menu disappears.
- 4 After selecting the desired **Control Area**, use the **Arrow** buttons on the remote control to select the menus and options. Search menu can also be displayed by placing the mouse cursor on the upper portion of the screen.

The **Control Area** consists of **Menu**, **Screen**, **Record Table Search**, and **Playback**.

- ① **Menu**: Activates side Search menu. Use the arrow buttons to select an option.
- ② **Screen**: Activates the middle screen section. Use the arrow buttons to select a camera.
- ③ **Record Table Search**: Activates the bottom record table. Use the arrow buttons to select a record table.
- ④ **Playback**: Activates the Playback mode. Use the arrow and enter buttons to operate the playback mode.

Search Menu

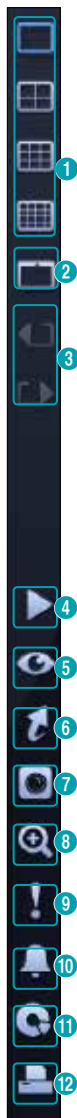

① Layout

Used to change the screen layout.

② Display

- **OSD On/Off:** Enables/disables the OSD feature.
- **Original Ratio On/Off:** Setting On displays video on the camera screen in its original ratio.

③ Previous/Next Group

Loads the previous/next screen group. (in single screen only)

④ Search Mode

Search by changing Time-Lapse Search and Event Log Search.

⑤ Live Mode

Activates Live mode.

⑥ Go To

Search video recordings based on date and time. Specify the date and time and then select Go to jump to the corresponding video recording. Select a  (bookmark) button on the right side to move to the saved bookmark position.

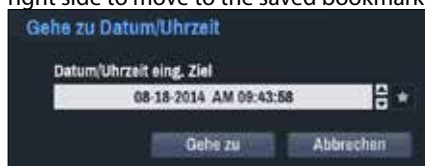

⑦ Select Camera

Select a camera channel and display it as a single screen.

⑧ Zoom

Zoom in.

⑨ Panic Recording

Use the Panic Record feature.

⑩ Alarm

Pressing this button while the alarm has been activated resets all NVR alarm outputs, including the built-in buzzer.

⑪ Database

- **Record:** Search recording data contained in the main recording device.
- **Other:** Search data recorded while disks used in other systems were connected.

⑫ Print

Print the current image.

Time-Lapse Search Menu



1 Record Table

Display the current channel's recording information.

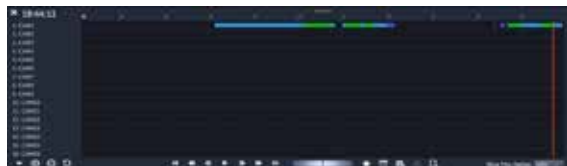

Recording date and time are shown on the top of the search window. The grey indicator line on Record Table indicates the current playback position. Use the arrow buttons on the remote control to move the current playback position in units of individual sectors. Alternatively, use the mouse to jump to the desired playback position.

- Farther back the data is on the record table, the more recent it is.
- If the system's clock is changed to a previous date and time, it is possible for multiple recordings with the identical time stamp to exist. Overlapped segments are highlighted in yellow.

Select **+** (zoom-in) to compose recording data in 1-minute segments and select **-** (zoom-out) to compose recording data in 3-minute segments. Selecting zoom-out displays more time in one screen than zoom-in screen.

If recording from points in time prior or after the time frame displayed on the screen is available, scrolls appear on both ends of the date and time information line. Scroll using the arrow buttons on the remote control or by dragging with the mouse to check recording data. Display the latest update recording information when selecting **↻** (Refresh).



Recording Data Bar Colors

Blue	█	Time Lapse Recording
Purple	█	Event Recording
Yellow	█	Pre-Event Recording
Red	█	Panic Recording
Green	█	Faulty recording due to a temporary disruption in device connection.

② Playback Controls

Play and scan through video recordings. Playback controls have the same functions as their remote control counterparts.

• Jog Shuttle

Adjust the playback method and speed.

Jog shuttle's vertical indicator indicates the current playback direction and speed. Vertical indicator placement to the right of the center means the video is being played back in the forward direction. Placement to the left means the opposite. Farther away the vertical indicator from the center, faster the playback speed. Click and drag the vertical indicator to adjust the playback speed. Releasing the mouse button returns the vertical indicator to the center and stops video playback.

③ Bookmark

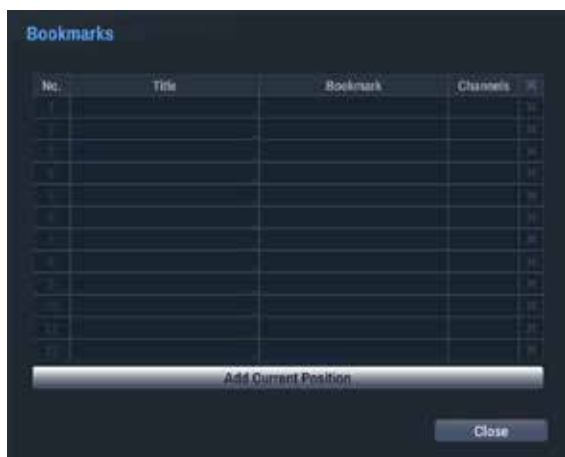

Select **Add Current Position** to add a bookmark to the current playback position. Select **Title** and enter the name of the registered bookmark.



The maximum number of bookmarks that can be saved is 12.

Select a bookmark from the Bookmarks window to move to the registered playback position.

Select Bookmark list and then the **icc** to delete the corresponding bookmark.

④ Calendar Search

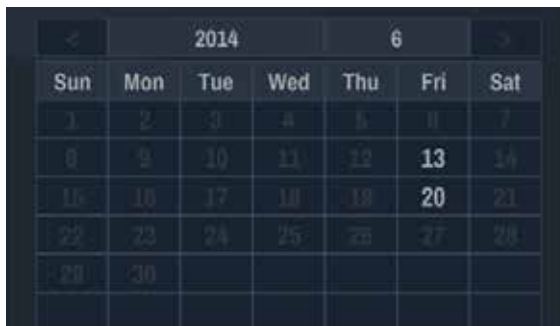

Use the calendar to search for video recordings by specific dates.

Dates containing video recordings are highlighted in light grey. Selecting a date containing video recording data loads the earliest recording from that date (paused state). Selected date is highlighted in black of grey background.

⑤ Clip-Copy

• A-B Clip-Copy

Designate a start point and an end point and copy the data in between. The Clip-Copy Setup window will appear. Select A and B points are automatically applied as **From** and **To** values.

• Clip-Copy

Open up the **Clip-Copy** Setup window. Specify the **From** and **To** settings. Pressing the remote control's **CLIP COPY** button while in Live or Playback mode will also open the **Clip-Copy** setup window.



- **Channels:** Specify which channel to save the recording to.
- **Password:** Enable password protection for the saved video clip and assign a password.
- **Dest.:** Select which storage media to use.
- **File name:** Designate a name for the file. The name may be up to 63 characters in length.

Part 4 - Search

✓ Special characters such as \, /, ;, ;, *, ?, !, ", <, >, and | are not permitted.

- **Include Text-In Data:** Enabling this option will save the video clip along with any available text-in data.
- **Use Site Info:** Adds **Site** info to the Clip Copy file's name.

✓ Special characters contained in the location info (such as \, /, ;, ;, *, ?, !, ", <, >, and |) will be replaced with _ when the information is added to the file name.

Selecting **Start** displays a calculation on the size of the data to be copied. Check the calculation and then select **Continue** to proceed. While Clip Copy is in progress, you can select **Cancel** to cancel the process or select **Close** to allow the window to run in the background. Selecting **Close** does not cancel Clip Copy. Once the process is complete, you will be prompted with a confirmation window.

- ✓ • **One-Touch Clip Copy** configures the storage range automatically based on the storage drive's capacity. If there is insufficient space available on the selected storage device, you will only be able to Clip Copy an amount of data equaling the remaining space available on the storage device.
- The maximum size limit on Clip Copy files is 30GB. Saving a segment that is more than 2GB in size produces multiple files that are up to 2GB in size, each. The maximum size limit for One-Touch Clip Copy files is 2GB.
- Clip Copy files can be played back on Windows systems. For more information, refer to the REVO Remote Pro operation manual.
- For USB flash memory devices, the NVR supports the FAT32 file format only.

⚠ Do not disconnect the USB cable or power off the USB device while USB Clip Copy is in progress. Doing so can cause the NVR to malfunction or critically damage the external USB device's file system. You may be prompted with an error message when trying to back up on the device. If so, you will need to restart the NVR. If the USB hard disk's file system has been damaged, restarting the NVR will not solve the problem and the aforementioned error message will continue to be displayed each time you attempt a backup. If this is the case, you will need to format the HDD or use a recovery program to repair the damage to the drive's file system.

⑥ Motion Search

(This function supports only in single screen.)

Motion Search cannot be performed while using a split screen layout. Select Single Screen mode.

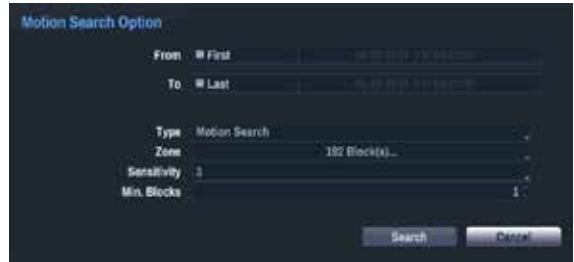

- Select **First** under **From** and **Last** under **To** to search the recording from start to finish. Alternatively, you can uncheck the **First** and **Last** options and specify the search time frame manually.
- **Type: Motion Search** looks for motion in the selected area by comparing individual frames against their preceding frames. This means slow and gradual movements, no matter how long they persist, will not be recognized. In contrast, **Museum Search** looks for changes in the specified area by using the **From** frame as a reference. Museum Search, therefore, recognizes even minute deviations from the original **From** frame.
- The **Zone** setting can be configured in the identical manner as the Zone setting under System Setup - Motion Detection. For more information, refer to the **Motion on page 45**.
- ✓ • **Museum Search** may not function properly if the edge of the object is included in the **Zone**. For more accurate search results, set the inside of the object's edge as the detection zone.
- **Sensitivity:** Set to between 1 (Low) and 5 (High).
- **Min. Blocks:** The **Min. Blocks** option is available with Motion Search only.

Once all the options have been configured, select **Search**. Select search results entry to display the video recording on the left. To play the recording, exit the setup window by selecting **Close**.

⑦ Text-In Search

Perform Text-In Search.

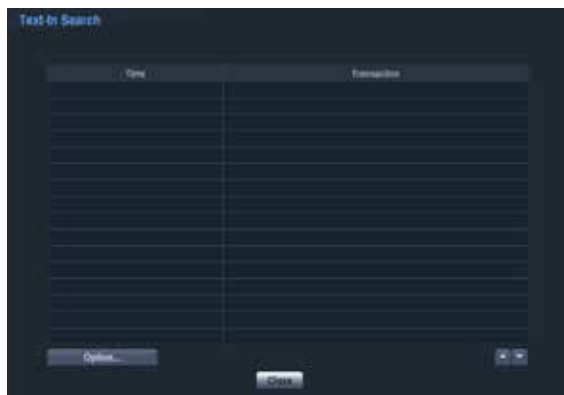

Select a **Transaction** to display the video recording that corresponds to the selected time and date (paused state).

- Text-in information is superimposed on the screen at normal playback speed. The information is not shown under any other playback speed.

Select **Option...** to configure Text-In Search options.



- Select **First** under **From** and **Last** under **To** to search the recording from start to finish. Alternatively, you can uncheck the **First** and **Last** options and specify the search time frame manually.
- **Channels**: Select a channel.
- Select **Text-In Device** to select a device type.
- **+ Button**: Add a search variable.
- **Case Sensitive**: Configure case sensitivity.
- **Load**: Retrieve stored search option settings.
- **Save**: Save the current search option settings.

Once all the options have been configured, select **Search** to begin the search and return to the **Text-In Search** setup window.

⑧ Slow Play Option

Search the playback screen at low speeds. Select the

desired playback speed (x1/2, x1/3, x1/4, x1/6, x1/8) and then select Play.

Context Menu

Select the Menu button or right-click on the Camera screen to access the context menu.

- **Zoom**: Zoom in.
- **Audio**: Enable/disable audio. Audio playback of the selected camera is available in full screen mode only.
- **Show/Hide Text-In**: Show/hide text-in information contained in the recording.
- **Edit Group**: Rearrange the split screen layout.

Print

Print the current image.

While in **Search Mode**, select **Pause** to pause playback. Select **Print** from the Search menu to open up the Print Setup window.

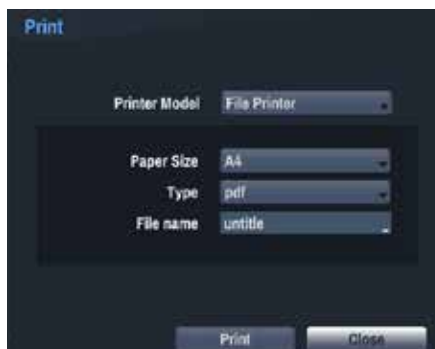

- **Printer Model**
 - **File Printer**: Saves the current frame to the USB storage device as a .pdf file that can be printed on the printer connected to a computer.
- **Paper Size**: Select the desired paper size.
- **File name**: Designate a name for the file.

Event Log Search

Select **Search Mode > Event Log Search** to bring up the Event Log Search window.

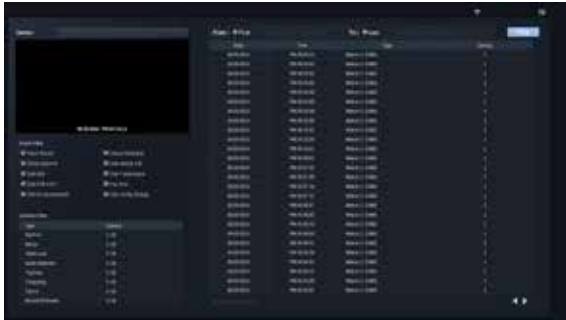

- Select an event to display the recording made on the selected time and date (paused state). Select the Play button in the middle of the screen to start playing back the recording. Use the drop-down menu above to load recordings from other cameras.
- You can uncheck the **First** and **Last** options at the top of the Event Log Search window and specify the search time frame manually.



Select **First** for From and **Last** for To to select the entire recording from start to end.

- If designating **From** or **To** settings manually, you will be able to enable/disable the **Check Time Overlap** option.



If the system's clock has been changed and the designated **From** or **To** point exists at more than one location, you will have to choose one. Only the events that took place between the selected **From** and **To** points will be searched. If **Check Time Overlap** has not been selected, events from the entire **From** and **To** range will be searched.

Use event filters to include/exclude specific system events such as **Panic Record, Check Recording, Check Alarm-In, Disk Almost Full, Disk Bad, Disk Temperature, Disk S.M.A.R.T., Fan Error, eSATA Disconnected** and **Disk Config Change** from the search.

Camera Filter

- **Alarm-In:** Select which channels to search alarm-in events in.
- **Motion:** Select which channels to search motion detection events in.
- **Video Loss:** Select which channels to search video loss events in.
- **Audio Detection:** Select which channels to search audio detection events in.
- **Trip Zone:** Select which channels to search trip zone events in.
- **Tampering:** Select which channels to search tampering events in.
- **Text-In:** Select which channels to search text-in events in.
- **Record Channel:** Select which record channels to search events in.



Selected record channels are searched for events with at least one linked recording. If no camera is selected, only the events with no linked recording camera are searched.

Overlapped Recording Search

If the system's clock is changed to a point in the past, overlapping recordings may be produced. Overlapped recordings have to be searched in segments.

For example, making a recording from 1 o'clock to 5 o'clock, changing the system's clock at 5 o'clock to 3 o'clock, and then continuing to record until 6 o'clock produces two recordings that overlap between 3 o'clock and 5 o'clock. This results in two segments for the period between 3 and 5.

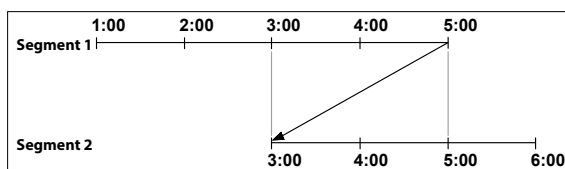

When searching overlapped video recordings, you can choose a specific point in time or a time frame. If you use the **Go to the Date/Time** option and select a point within the overlapped time period (**4 o'clock**, for example), you must specify **4 o'clock** in which of the two existing segments.



If you use the **Event Log Search** or **Motion Detection** option and select a time frame within the overlapped time period (**4 o'clock to 5 o'clock**, for example), you must choose between the two redundant sets of From and To values. Selectable search ranges are as follows:

- 4 o'clock in segment 1 to 5 o'clock in segment 1
- 4 o'clock in segment 1 to 5 o'clock in segment 2
- 4 o'clock in segment 2 to 5 o'clock in segment 2

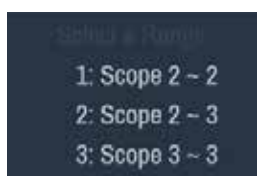

Part 5 - WebGuard

WebGuard is a program that allows you to view and search video from remote locations over the Internet and can be accessed on a regular web browser such as Internet Explorer.

System requirements for running WebGuard are as follows:

- OS: Microsoft® Windows® XP (Service Pack 3), Microsoft® Windows® Vista (Service Pack 1), Microsoft® Windows® 7 (Home Premium, Professional, Ultimate) or Microsoft® Windows® 8 (Pro, Enterprise)
- CPU: Intel Pentium IV 2.4GHz or above (Core 2 Duo E4600 recommended)
- RAM: 1GB or more
- VGA: 128MB or more (1280x1024, 24bpp or above)
- Internet Explorer: Ver. 7.0 or above (32-Bit)

- WebGuard only works with Microsoft Internet Explorer and will NOT work with other browsers.
- WebGuard does not work in Microsoft® Windows® 8 metro UI.

- 1 Launch Internet Explorer and then enter the following information in the address bar.
- http://IP Address:Port Number (NVR system's IP address and WebGuard port number configured under Network > General (Default Value: 12088))
 - http://FEN server address/FEN Name (FEN Name: NVR name configured on the FEN server)
 - http://www.dvronline.net (will be prompted to enter NVR's IP address or FEN name registered to the FEN server upon login)

- Contact your network administrator for the IP address of the NVR you wish to connect to and the WebGuard port number.

- 2 When prompted with the WebGuard login window, select **WEBWATCH** or **WEBSEARCH** as the desired mode. Enter the ID and password and click **LOGIN** to sign in using the selected mode.



If connecting by entering http://www.dvronline.net, enter the NVR's IP address in the Device Address field. Selecting the Use DVRNS option on the login window allows you to enter the NVR name registered to the FEN server instead of its IP address. You will be prompted to enter the FEN server's address and port number under Setup.



- Do not close the login window while WebGuard is running. Switching over to Web monitoring or Web Search mode can cause a script error, requiring you to restart the WebGuard program.
- If running WebGuard, the bottom section of the screen may get cut off if the address bar or the status bar is shown. In this case, change Internet Options so that the address bar or the status bar is hidden. (**Tools** → **Internet Options** → **Security** → **Custom level...** → **Allow websites to open windows without address or status bars (Enable)**)
- To use WebGuard on Microsoft Windows Vista or above, launch Internet Explorer by right-clicking on the icon and selecting the **Run as administrator** option. Otherwise, certain WebGuard functions might not be available.





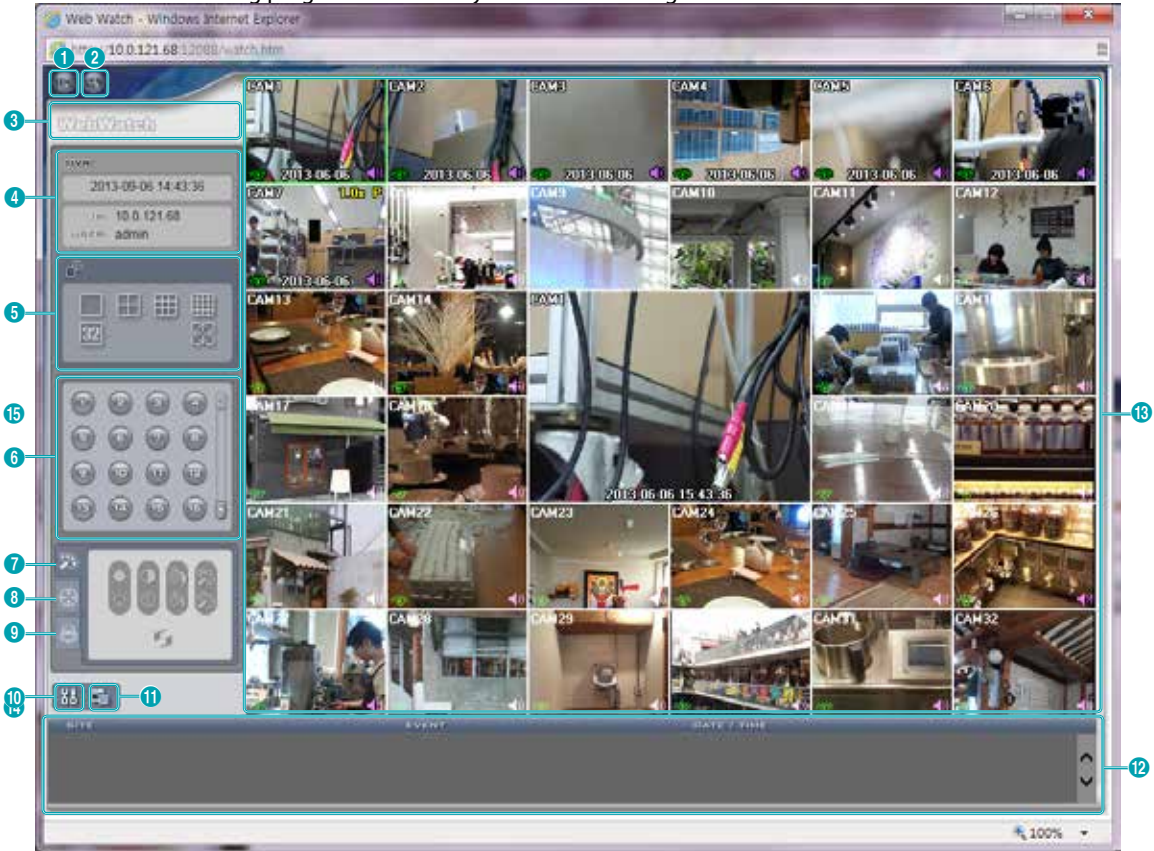











- Launching a new version of WebGuard for the first time can cause Internet Explorer to load information from the previous version. In this case, navigate to **Tools** → **Internet Options** → **General**, delete temporary Internet files, and then restart WebGuard.
- On Microsoft Windows Vista or above, lowered image transmission rate can prevent the screen from being displayed or updated. In this case, we recommend that you disable the computer's auto tuning function. Open the command prompt as an administrator. (**Start** → **Accessories** → **Command Prompt** → **Right-Click** and then select **Run as administrator**) Type in "**netsh int tcp set global autotuninglevel=disable**" and then press Enter. Restart the computer to apply the change. To enable auto tuning again, launch the command prompt as an administrator and then type in "**netsh int tcp set global autotuninglevel=normal**". Restart the computer to apply the change.

Web Monitoring Mode

A remote web monitoring program that allows you to monitor images from remote locales in real-time.



1	Press  to log out WebGuard.
2	Click  to switch over to Web Search mode.
3	Place the mouse pointer on the WebWatch logo to check WebGuard's version.
4	Displays the current time and login information of WebGuard.

5	Select the desired mode. Changing the mode places the selected camera in the first cell of the layout that will be changed.								
6	Select the camera you wish to monitor.								
7	Used to adjust live video quality.								
8	Used to control a PTZ camera at a remote location.								
9	Controls remote alarm out devices.								
10	Click  to configure rendering mode and OSD settings. Select rendering mode to adjust the video output rate or select which OSD elements to display on the screen from the OSD list.								
11	Click  to save the current video screen as an image file.								
12	Event status window at the bottom of the screen displays a list of events detected at remote locales.								
13	<p>Select a camera from the screen and right-click to bring up the pop-up menu.</p> <ul style="list-style-type: none"> Change Camera Title: Used to change the camera's name. <div data-bbox="1033 658 1245 794" style="border: 1px solid black; padding: 5px; margin: 10px 0;"> Change Camera Title Enable Audio Aspect Ratio  Anti-Aliasing Screen </div> <div data-bbox="234 720 285 774" style="display: inline-block; border: 1px solid black; padding: 2px;"> <input checked="" type="checkbox"/> </div> Renaming the camera in Web Live mode does not affect the camera's name on the remote system. If no name is entered for the camera, the name used at the remote locale is shown on the screen. Enable Audio: Enables audio transmission with remote locales. Select to display  buttons. <table border="1" data-bbox="234 884 1270 1049" style="width: 100%; border-collapse: collapse;"> <tr> <td style="text-align: center;"></td> <td>Enables transmission of audio to the remote locale via microphone.</td> </tr> <tr> <td style="text-align: center;"></td> <td>Enables playback of audio from the remote locale on speakers.</td> </tr> <tr> <td style="text-align: center;"></td> <td>Enables two-way audio communication with the remote locale.</td> </tr> <tr> <td style="text-align: center;"></td> <td>Disables audio transmission.</td> </tr> </table> <div data-bbox="234 1083 285 1137" style="display: inline-block; border: 1px solid black; padding: 2px;"> <input checked="" type="checkbox"/> </div> <p>If the remote locale connected to supports audio transmission,  icon appears on the corresponding camera screen.</p> <ul style="list-style-type: none"> Aspect Ratio: Changes the aspect ratio of the video displayed on the screen. <ul style="list-style-type: none"> - Fit to Screen: Fit the video to the size of the camera screen. - Fit to Aspect Ratio: Resizes camera screen to original aspect ratio of the video. - Half Size (x0.5) - 4 Times Bigger (x4): Displays the camera videos in the selected size based on the original size of the video. For example, original size (x1) displays the video in its original size. Half size (x0.5) through 4 times larger (x4) options are only available if there is enough space on the camera screen to accommodate the selected size. Anti-Aliasing Screen: Removes stair step effect (blocks) that is caused when zooming a video to improve overall quality of video output. 		Enables transmission of audio to the remote locale via microphone.		Enables playback of audio from the remote locale on speakers.		Enables two-way audio communication with the remote locale.		Disables audio transmission.
	Enables transmission of audio to the remote locale via microphone.								
	Enables playback of audio from the remote locale on speakers.								
	Enables two-way audio communication with the remote locale.								
	Disables audio transmission.								



Web Search Mode

A remote web search program that allows you to search for recordings from remote locales in real-time.

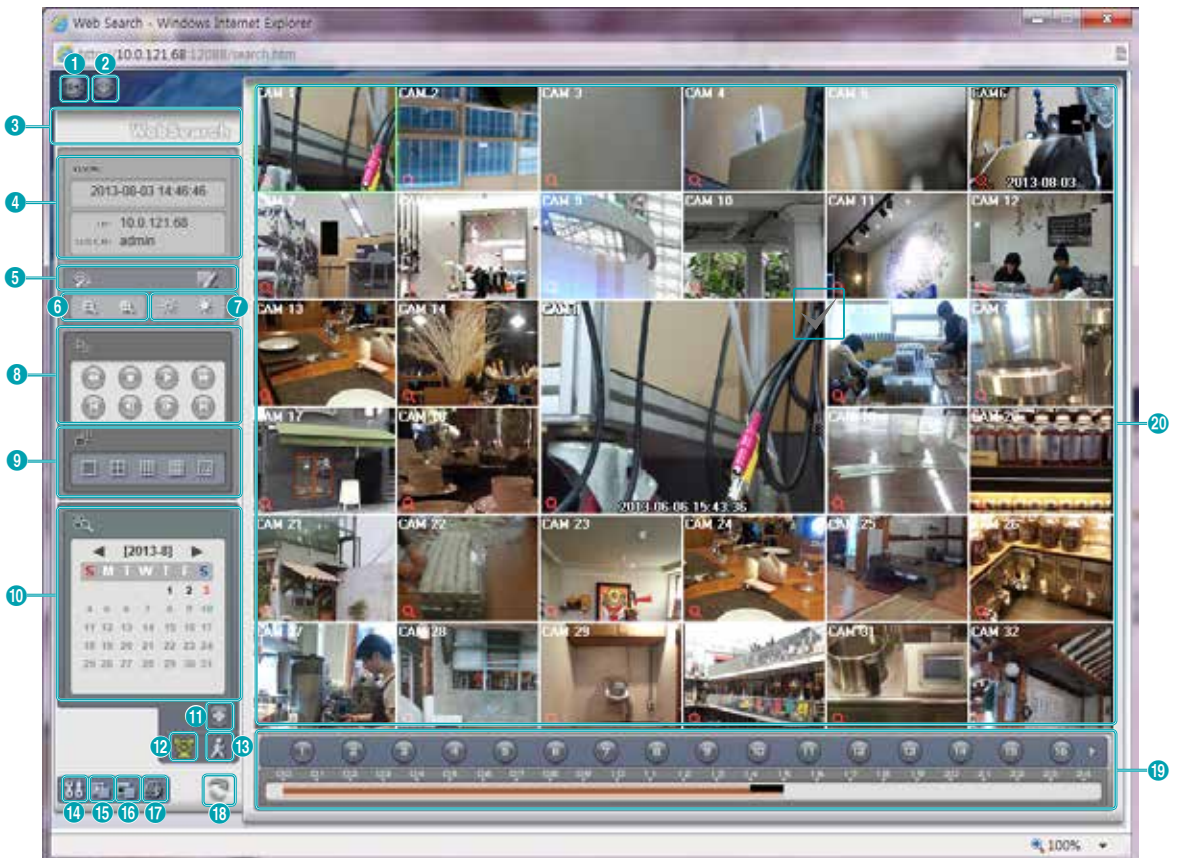

While in Web Search mode, connection to remote locales will terminate automatically after 30 minutes of inactivity.



1	Press  to log out WebGuard.
2	Click  to switch over to Web monitoring mode.
3	Place the mouse pointer on the WebSearch logo to check WebGuard's version.
4	Displays time information of the video recording from the remote NVR.
5	Apply image filters (Sharpen, Blur, Equalizer, Interpolation, and Revert) to the images. <input checked="" type="checkbox"/> Image calibration is applied only during the paused state.

6	Zoom in or out on the video.						
7	Adjust image brightness.						
8	Use the playback controls to play back video.						
	<table border="1"> <tr> <td data-bbox="203 322 299 363"></td> <td data-bbox="299 322 686 363">Go to First</td> <td data-bbox="686 322 782 363"></td> <td data-bbox="782 322 1264 363">Fast Forward</td> </tr> </table>		Go to First		Fast Forward		
		Go to First		Fast Forward			
	<table border="1"> <tr> <td data-bbox="203 363 299 403"></td> <td data-bbox="299 363 686 403">Play by Frame (backwards)</td> <td data-bbox="686 363 782 403"></td> <td data-bbox="782 363 1264 403">Play by Frame (forwards)</td> </tr> </table>		Play by Frame (backwards)		Play by Frame (forwards)		
		Play by Frame (backwards)		Play by Frame (forwards)			
<table border="1"> <tr> <td data-bbox="203 403 299 444"></td> <td data-bbox="299 403 686 444">Rewind</td> <td data-bbox="686 403 782 444"></td> <td data-bbox="782 403 1264 444">Go to Last</td> </tr> </table>		Rewind		Go to Last			
	Rewind		Go to Last				
<table border="1"> <tr> <td data-bbox="203 444 299 494"></td> <td data-bbox="299 444 686 494">Play/Pause</td> <td data-bbox="686 444 782 494"></td> <td data-bbox="782 444 1264 494"></td> </tr> </table>		Play/Pause					
	Play/Pause						
9	Select the desired mode.						
10	Use the calendar to search for video recordings by specific dates. Dates containing video recordings are highlighted in black. Selecting a date containing video recording data loads the earliest recording from that date(paused state). Selected date is highlighted in red.						
11	Click to designate recent recordings you wish to search and then jump to a specific point in the recording.						
12	Select to enable time lapse search mode and search/play back video recordings in chronological order. In Time Lapse Search mode, search is conducted by selecting days on the calendar. The time table at the bottom displays recording data information for the selected date. Select a point in time to display video from that moment. If multiple recordings are available for the selected point in time, you can select the desired segment.						
13	Select to enable event search mode and search for events matching user-designated parameters.						
14	Click to configure rendering mode and OSD settings. Select rendering mode to adjust the video output rate or select which OSD elements to display on the screen from the OSD list.						
15	Click to save the video recording as an executable file.						
16	Click to save the current video screen as an image file.						
17	Click to print the current video screen using a printer connected to the computer.						
18	Click to reload recent video recordings from remote locales.						
19	Indicates the selected camera's recording data on a time bar. If the camera's system clock has been changed to a point in the past and more than one recording exists at the same point in time as a result, you will be able to choose which segment to search from the segment menu on the upper right portion of the time table.						
20	<p>Select a camera from the screen and right-click to bring up the pop-up menu.</p> <ul style="list-style-type: none"> • Change Camera Title: Used to change the camera's name. <table border="1" data-bbox="1026 1437 1223 1568" style="float: right; margin-top: 10px;"> <tr> <td data-bbox="1026 1437 1223 1477">Change Camera Title</td> <td data-bbox="1026 1477 1223 1518">Enable Audio</td> </tr> <tr> <td data-bbox="1026 1518 1223 1559">Aspect Ratio</td> <td data-bbox="1026 1559 1223 1568" style="text-align: right;">▶</td> </tr> <tr> <td data-bbox="1026 1568 1223 1578">Anti-Aliasing Screen</td> <td></td> </tr> </table> • <input checked="" type="checkbox"/> Renaming the camera in Web Search mode does not affect the camera's name on the remote system. If no name is entered for the camera, the name used at the remote locale is shown on the screen. • Enable Audio: If audio was recorded with the video, enabling this option plays audio upon playback (limited to single-screen playback). • Aspect Ratio: Changes the aspect ratio of the video displayed on the screen. • Anti-Aliasing Screen: Removes stair step effect (blocks) that is caused when zooming a video to improve overall quality of video output. 	Change Camera Title	Enable Audio	Aspect Ratio	▶	Anti-Aliasing Screen	
Change Camera Title	Enable Audio						
Aspect Ratio	▶						
Anti-Aliasing Screen							

Part 6 - Appendix

System Log Types

Boot Up	Panic On
System Shutdown	Panic Off
Restart	Clear All Data
Upgrade Success	Clear Disk
Upgrade Error	Format Disk
Power Failure	Disk Full
Time Changed	Auto Deletion
Time Zone Change	Search Begin
Time Sync.	Search End
Time Sync. Failed	Clip-Copy Begin
Disk Bad	Clip-Copy End
Login	Clip-Copy Cancel
Logout	Clip-Copy Failure
Setup Begin	Clip Copy User
Setup End	Clip-Copy Begin
Remote Setup Change	Clip-Copy Finished
Remote Setup Failure	Clip Copy Duration of Video
Setup Import	Clip Copy Camera
Setup Import Failure	Callback Failed
Setup Export	Factory Reset
Setup Export Failure	Camera Upgrade Begin
Setup Export Canceled	Camera Upgrade End
SNS Failure	Camera Upgrade Failure
Schedule On	Camera Upgrade User
Schedule Off	Camera Upgrade Camera

Error Code Types

Upgrade Error Codes			
No.	Type	No.	Type
0	Unknown Error	301	Remote Network Error
1	Incorrect File Version	302	No Remote Upgrade Permission
2	Incorrect OS Version	303	Remote Upgrade File Save Failure
3	Incorrect Software Version	304	Remote Upgrade Cancelled by User
4	Incorrect Kernel Version	400	USB Storage Device Mount Failure
100	Storage Device Mount Failure	401	USB Storage Device File Read Failure
101	File Not Found	402	USB Storage Device File Copy Failure
102	File Decompression Failure	403	USB Device Not Connected
103	LILO Execution Failure	404	USB Storage Device in Use
104	Reboot Failure	405	Unsupported File System
105	Improper File	500	Clip Copy in Progress: Upgrade Not Available
300	Remote Connection Failure		

Clip Copy Error Codes			
No.	Type	No.	Type
0	Unknown Error	12	Disk Error
1	Device Error	13	Clip Player Execution File Not Found
2	Device Connection Failure	14	Clip Player Execution File Access Failure
3	CD Media Not Found	15	Clip Player Execution File Save Failure
4	Incorrect Media	16	Image Generation Failure
5	File Name Taken	17	Burn Failure
6	Insufficient Space	18	Burn Time Overrun
7	Temporary File Generation Failure	19	Device Connection Failure
8	Disk Access Failure	20	Device in Use
9	Disk Format Failure	21	Unsupported File System
10	Database Changed	22	Data Validation Failure
11	Save Failure	23	No Saved Data within Range

Network Error Codes			
No.	Type	No.	Type
0	Cause of Failure Unknown	20	Connection Cancelled by User
1	Normal Logout	21	No Response from Network Device Host
2	All Channels in Use - Connection Denied	22	High Network Noise Level
3	Incorrect Product Version Info	23	Transmission Queue Full
4	Incorrect User Name or Password	24	Incorrect OEM Info
5	Forced Disconnection by Admin	25	No Search Permission
6	Timeout	26	Port in Use
7	Network Device Terminated	27	SSL Connection Failure
8	Unable to Connect: No Available Port	28	Network Timeout
9	Server Not in Operation: Unable to Connect	29	Network Device Host Timeout
11	Network Unavailable	30	RTP via TCP Not Supported by Network Device Host
12	Different Network Zone: Unable to Access	31	Socket Error
13	Connection Timeout	100	Unknown CODEC
14	Forced Disconnection by Network Device	101	.jpeg CODEC (not supported)
15	Network Device Host Terminated	103	.mpeg4 CODEC (not supported)
16	Unable to Route to Network Device Host	400	Unsupported Resolution
17	Connection Severed	-1	Normal Access

Notes on first-time operation of ONVIF IP cameras (PX, PT, NX series)

To ensure the ONVIF IP camera operates perfectly together with recorders in the PNR-53xx series, set these parameters in the camera Setup:

- 1 Reset the camera to factory settings if it was already in operation.
- 2 Network Setup: Manual IP address / DHCP Client
- 3 Alarm Functions: Setting for Motion Detection and Alarm Contacts (I/O)
- 4 Audio Function: On/Off
- 5 Compression standard: H.264 (all streams)
- 6 Resolution e.g.: Stream 1 @ 1920x1080; Stream 2 @ 704x576; Stream 3 @ 320x240

After these settings have been made, the camera registration can be carried out.

For detailed information on setup of your IP camera, refer to its product documentation.

Please make sure that the total power consumption of the connected cameras does not exceed the maximum power output of the PoE switches integrated on the NVR. Power to the PoE switches is by means of a separate power supply.

Output PoE PNR-5316 / PNR-5308: Ports 1~4 max. 37W, Ports 5~8 max. 37W

Output PoE PNR-5304: Ports 1~4 max. 74W

Recommended Network Setups

Due to the diverse application possibilities of the PNR recorders, we recommend certain network setup options. The following examples show possible applications and the network setups suitable for the individual components.

For clarity, different IP segments in the following examples are marked as follows:

- S1 = IP Segment 1
- S2 = IP Segment 2



Important: The IP segments may not overlap other IP segments (manual, DHCP, ZeroConf). For example:

IP segment 1: 192.168.0.xxx, subnet mask: 255.255.255.0

IP segment 2: 10.0.0.xxx, subnet mask: 255.255.255.0

Cameras on the PNR, no WAN

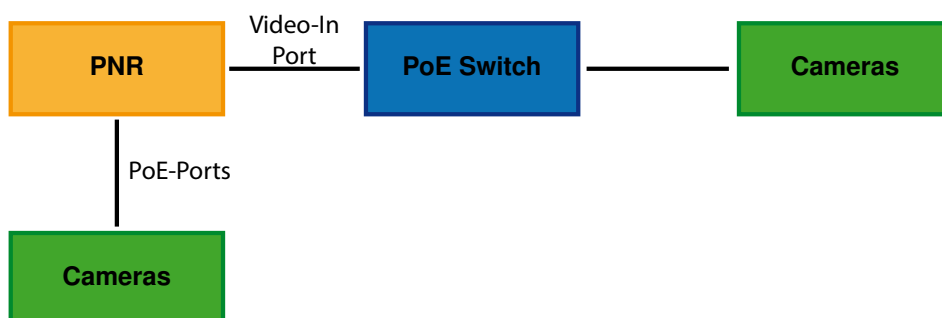

PNR Video-In / Video-In/PoE	PNR WAN	Camera
Manual (S1)	Manual (S2)	Manual (S1)
Manual (S1)	DHCP-Client	Manual (S1)
Link-local adress (ZeroConf)	Manual (S1)	ZeroConf (NX-Serie)
Link-local adress (ZeroConf)	DHCP-Client	ZeroConf (NX-Serie)
DHCP-Server (S1)	Manual (S2)	DHCP-Client (S1)
DHCP-Server (S1)	DHCP-Client	DHCP-Client (S1)

Cameras on the PNR with WAN

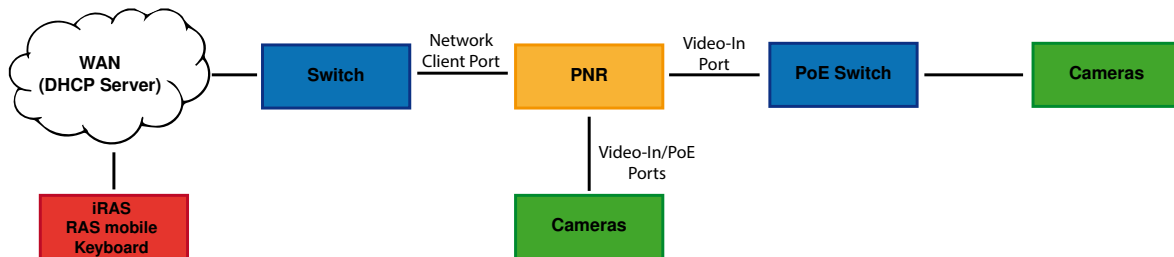

PNR Video-In / Video-In/PoE	PNR WAN	Camera
Manual (S1)	Manual (S2)	Manual (S1)
Manual (S1)	DHCP-Client (S2)	Manual (S1)
Link-local adress (ZeroConf)	Manual	ZeroConf (NX-Serie)
Link-local adress (ZeroConf)	DHCP-Client (S1)	ZeroConf (NX-Serie)
DHCP-Server (S1)	Manual (S2)	DHCP-Client (S1)
DHCP-Server (S1)	DHCP-Client (S2)	DHCP-Client (S1)

Cameras in the local network

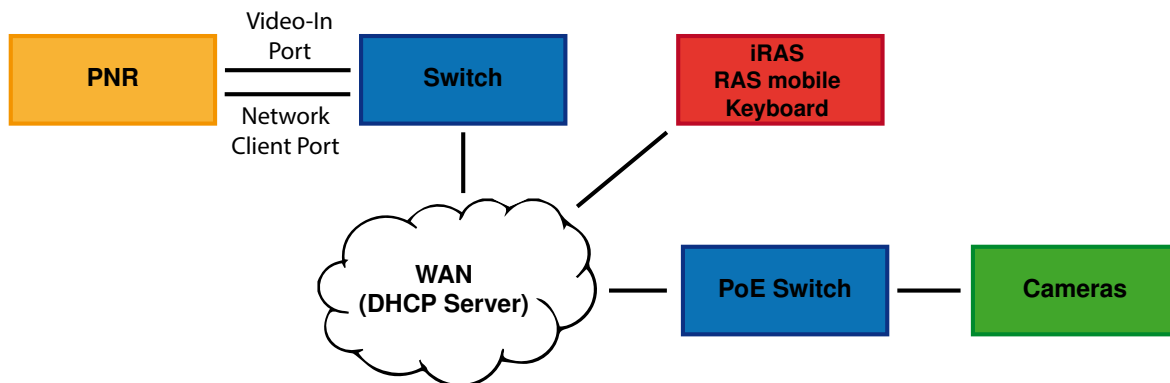

PNR Video-In / Video-In/PoE	PNR WAN	Camera
Manual (S1)	Manual (S1)	Manual (S1)
Link-local adress (ZeroConf)	Manual (S1)	ZeroConf (NX-Serie)
DHCP-Client (S1)	DHCP-Client (S1)	DHCP-Client (S1)
Link-local adress (ZeroConf)	DHCP-Client (S1)	ZeroConf (NX-Serie)

Cameras on the local network and on the PNR

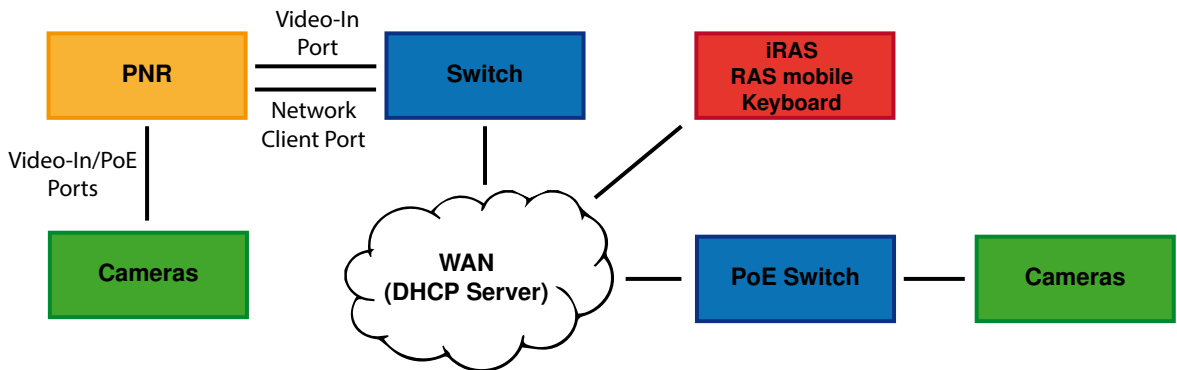

PNR Video-In / Video-In/PoE	PNR WAN	Camera over PoE	Camera over WAN
Manual (S1)	Manual (S1)	Manual (S1)	Manual (S1)
Manual (S1)	Manual (S2)	Manual (S1)	Manual (S1)
Link-local adress (ZeroConf)	Manual (S1)	ZeroConf (NX-Serie)	ZeroConf (NX-Serie)
DHCP-Client (S1)	DHCP-Client (S1)	DHCP-Client (S1)	DHCP-Client (S1)
Link-local adress (ZeroConf)	DHCP-Client (S1)	ZeroConf (NX-Serie)	ZeroConf (NX-Serie)

Troubleshooting

Problem	Solution
The main unit won't turn on.	<ul style="list-style-type: none"> • Check the power cable connection status. • Check the power outlet.
Unable to display Live video.	<ul style="list-style-type: none"> • Check the camera's video cable connection status. • Check the monitor's video cable connection status. • Check the camera's power setting. • Check the camera lens settings.
PoE-enabled camera will not turn on.	<ul style="list-style-type: none"> • Verify that the camera is actually PoE-enabled. • Check the network cable, replace it, and try again. • Check the PoE adapter is not defective and power adapter is properly connected.
NVR stopped working in the middle of a recording.	<ul style="list-style-type: none"> • Hard disk may be full. Delete video recordings to free up space. • Set the NVR to Recycle mode. For more information, refer to the General on page 42.
● icon is shown, but video is not being recorded.	<p>If the Pre-Event is enabled, the 🛠️ and ● icons appears when recording is not in progress, or the 🛠️ and ● icons appear when an event occurs and recording is in progress. For more information, refer to the Schedule on page 43.</p>
The NVR keeps on rebooting during a system upgrade without completing the upgrade.	<p>Check the upgrade file's version. To downgrade to a previous version, you must first press the factory reset button and reset all NVR settings to their factory defaults. A factory reset will clear all NVR settings configured by the user. For more information on factory reset, refer to the Factory Reset section on page 90.</p>

Specifications

These product specifications may change without prior notice.

General	
Exterior Dimensions (W x H x D)	11.81" x 2.40" x 9.09" (300mm x 61mm x 231mm)
Weight (Main Unit)	6.08 lbs (2.76kg) (with 1 TB 2HDDs)
Weight (Packaging)	10.53 lbs (4.78kg) (with 1 TB 2HDDs)
Packaging Dimensions (W x H x D)	18.11" x 4.45" x 14.17" (460mm x 113mm x 360mm)
Working Temperature	5°C – 40°C
Operating Humidity	0% – 90%
Power	NVR Adaptor : INPUT (100-240V~,50/60Hz,1.5A), OUTPUT (12V $\overline{\text{---}}$, 5A) PSE Adaptor : INPUT (100-240V~,50/60Hz,1.4A), OUTPUT (48V $\overline{\text{---}}$, 1.36A)
Power Consumption	*NVR : 12V $\overline{\text{---}}$, 2.1A, 25.2W PSE : 48V $\overline{\text{---}}$, 1.0A, Max. 48W
Certifications	FCC, CE

* When two HDDs(3TB) are installed, the value above was measured.

Video	
Video In	4/8/16 Network Camera (Video In Port : 4/9/9)
Monitor Out	HDMI: 1 HDMI VGA: 1 DB15
Video Resolution	1920 x 1200, 1920 x 1080, 1680 x 1050, 1600 x 1200
Recording Speed (IPS)	480ips @ Full HD (PNR-5316) 240ips @ Full HD (PNR-5308) 120ips @ Full HD (PNR-5304)
Playback Speed (IPS)	120ips @ Full HD

I/O	
Alarm In	4 TTL, NC/NO programmable, 2.4V (NC) or 0.3V (NO) threshold, 5VDC
Alarm Out	1 relay output, 2A@125VAC, 1A@30VDC (NO)
Internal Buzzer	78dB at 10cm
Network Connection	10Mbps/100Mbps/1Gbps Ethernet
Audio In	Network Audio In
Audio Out	1 line Audio Out, RCA
Text In	POS Interface, ATM Interface

Connectors	
Video In	Ethernet: 4/9/9 ports (PNR-5304/5308/5316)
Camera Power Out	Ethernet: 4/8/8 ports (PNR-5304/5308/5316)
Monitor Out	HDMI: 1 HDMI VGA: 1 DB15
Audio Out	1 RCA connector
Alarm	Terminal block
Ethernet Port	1 RJ-45
eSATA Port	1 eSATA
RS-232 Serial Port	Terminal block, text insertion (POS/ATM)
IR Remote Control Port	Remote Control
USB Ports	1 x USB 2.0, 1 x USB 3.0 (5V, less than 0.5A)

Storage	
Internal Storage	2 SATA2 bays
External Storage	eSATA 1 port
Clip Copy Device	USB Storage Device (USB HDD, USB Memory, etc.)

Some hard disks may not function properly when mounted on to this product. Refer to the compatibility chart below before mounting any additional hard disk on to the product. Hard disk compatibility chart is subject to change without notice. Contact your retailer for the latest compatibility chart.

Storage	Manufacturer	Model	Note
1TB	Seagate	ST31000322CS	
		ST1000VM002	
	Western Digital	WD10PURX-64D85Y0	
		WD10EURX-64RPPY0	
2TB	Seagate	ST2000VM003	
	Western Digital	WD20PURX-64P6ZY0	
	TOSHIBA	DT01ACA200	
3TB	Seagate	ST3000VX000	
	Western Digital	WD30PURX-64P6ZY0	
	TOSHIBA	DT01ACA300	

Index

A		S	
Audio Recording	34	Schedule	43
E		Search	64
Event Monitoring	32	Storage	40
F		Stream	62
FEN	52	T	
L		Text-In	50, 51
Live Mode	27	Timelapse Mode	64
Login	26	Time-Lapse Search	65
M		U	
Motion Search	68	Upgrade	63
Mouse	36	V	
O		Video-Analytics	45
OSD	54	W	
P		WebGuard	72
Panic Recording	33	Wizard	21
Pre-Event	44	R	
PTZ Control	31	Recording	33
R		Record Setup	42



eneo® is a registered trademark of VIDEOR E.
Hartig GmbH
Exclusive distribution through specialised trade
channels only.

VIDEOR E. Hartig GmbH
Carl-Zeiss-Straße 8 · 63322 Rödermark/Ger-
many
Tel. +49 (0) 6074 / 888-0 · Fax +49 (0) 6074
/ 888-100
www.videor.com
www.eneo-security.com

Technical changes reserved

© Copyright by VIDEOR E. Hartig GmbH
01/2015